

**ENCLAD™ EN02 SUPPORT SYSTEM  
HOOK ON SECRET FIXED**

**DRAWING REGISTER**

PAGE	DETAIL DESCRIPTION	DETAIL #	REV.
00/16	COVER PAGE	00	NOV 22
01/16	CAVITY SET OUT	01	NOV 22
02/16	SCHEMATIC	02	NOV 22
03/16	VERTICAL PANEL JOINT DETAIL (PLAN VIEW)	03	NOV 22
04/16	PANEL MIDSPAN SUPPORT DETAIL (PLAN VIEW)	04	NOV 22
05/16	BRICKWALL ABUTMENT DETAIL (PLAN VIEW)	05	NOV 22
06/16	INTERNAL CORNER PANEL DETAIL (PLAN VIEW)	06	NOV 22
07/16	EXTERNAL CORNER PANEL DETAIL (PLAN VIEW)	07	NOV 22
08/16	WINDOW JAMB DETAIL (PLAN VIEW)	08	NOV 22
09/16	DOOR JAMB DETAIL (PLAN VIEW)	09	NOV 22
10/16	CONCRETE WALL ABUTMENT DETAIL (PLAN VIEW)	10	NOV 22
11/16	HORIZONTAL PANEL JOINT DETAIL (SECTION VIEW)	11	NOV 22
12/16	PARAPET FLASHING DETAIL (SECTION VIEW)	12	NOV 22
13/16	WINDOW HEAD DETAIL (SECTION VIEW)	13	NOV 22
14/16	DOOR HEAD DETAIL (SECTION VIEW)	14	NOV 22
15/16	WINDOW SILL DETAIL (SECTION VIEW)	15	NOV 22
16/16	BRICKWALL AT BASE DRIP DETAIL (SECTION VIEW)	16	NOV 22

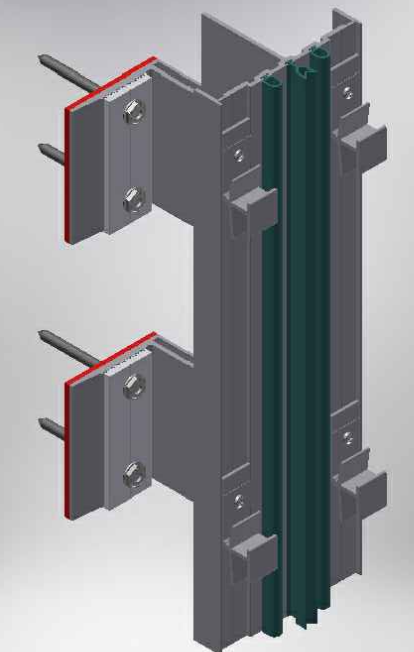

PART OF THE THERMOSASH GROUP COMPANIES :



**COPYRIGHT :** THESE DESIGNS, DETAILS AND/OR SPECIFICATIONS AND THE COPYRIGHT THEREIN, REMAIN THE PROPERTY OF INSITE FACADES LTD.

**DISCLAIMER :** THESE DETAILS ARE PROVIDED FOR INDICATIVE PURPOSES ONLY. CONSTRUCTION/SYSTEM DETAILS CAN VARY DEPENDING ON PROJECT SPECIFIC SPECIFICATION AND ENGINEERING REQUIREMENTS. THE DESIGNER IS RESPONSIBLE FOR ENSURING DETAILS SATISFY ALL NEW ZEALAND BUILDING CODE CLAUSES. THE DESIGNER IS RESPONSIBLE FOR ENSURING BUILDING WRAPS, FIRESTOPS AND INSULATION/SPECIFICATION COMPLY WITH MANUFACTURERS RECOMMENDATIONS AND NZBC REGULATIONS. REFER TO INSITE WEBSITE FOR FULL TERMS AND CONDITIONS.

Cladding Type :  
**ENCLAD™ TERRACOTTA TILES - HORIZONTALLY LAID**

Support System :  
**ENCLAD™ EN02 - HOOK ON SECRET FIXED**

Detail Description :  
COVER PAGE

Scale @ A3 : Rev. : NOV 2022

System # : Detail # :  
TERRA-H-EN02-HOR-SF3 00

**ENCLAD™ RAINSCREEN SYSTEMS**



101 STATION ROAD, PENROSE,  
AUCKLAND 1061  
NEW ZEALAND

P: +64 9 307 1529  
[www.insitefacades.co.nz](http://www.insitefacades.co.nz)

EN02 - ADJUSTABLE SYSTEM CAVITY

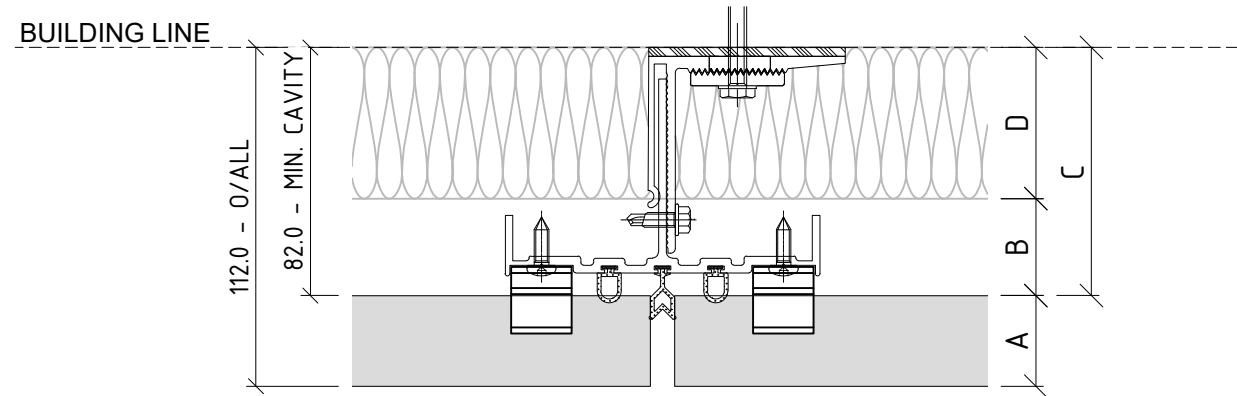

50mm THICK INSULATION  
IN CAVITY ZONE

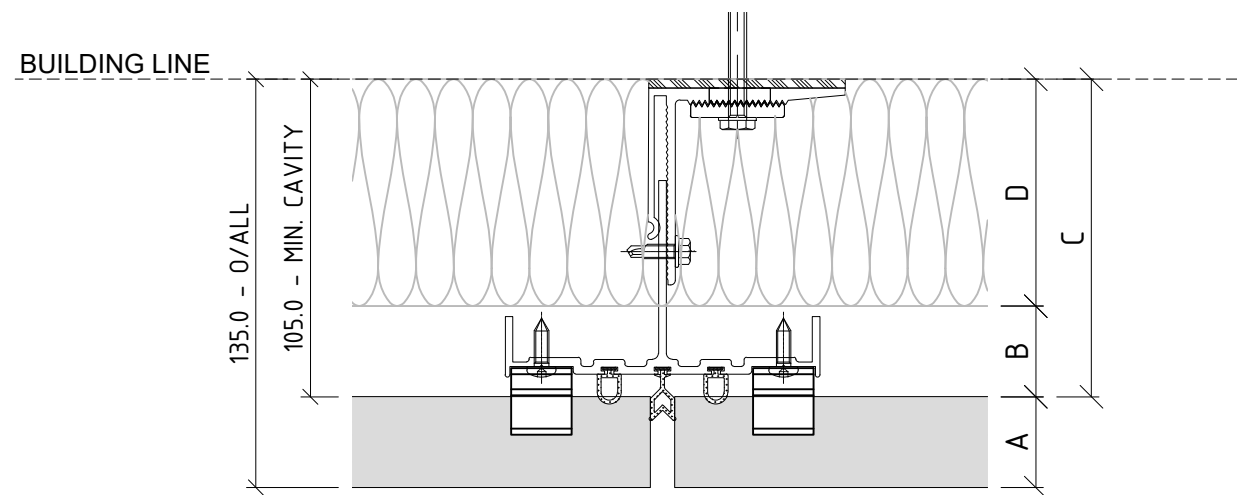

75mm THICK INSULATION  
IN CAVITY ZONE

01 CAVITY SET OUT  
ENCLAD™ TERRACOTTA TILES

ADJUSTABLE SYSTEMS ACCOMODATE BUILDING TOLERANCE AND INCORPORATION OF INSULATION FOR H1 REQUIREMENTS - STANDARD SYSTEM CAVITY SHOWN - BESPOKE OPTIONS AVAILABLE FOR PROJECT SPECIFIC REQUIREMENTS

PART OF THE THERMOSASH GROUP COMPANIES :



**COPYRIGHT :** THESE DESIGNS, DETAILS AND/OR SPECIFICATIONS AND THE COPYRIGHT THEREIN, REMAIN THE PROPERTY OF INSITE FACADES LTD.

**DISCLAIMER :** THESE DETAILS ARE PROVIDED FOR INDICATIVE PURPOSES ONLY. CONSTRUCTION/SYSTEM DETAILS CAN VARY DEPENDING ON PROJECT SPECIFIC SPECIFICATION AND ENGINEERING REQUIREMENTS. THE DESIGNER IS RESPONSIBLE FOR ENSURING DETAILS SATISFY ALL NEW ZEALAND BUILDING CODE CLAUSES. THE DESIGNER IS RESPONSIBLE FOR ENSURING BUILDING WRAPS, FIRESTOPS AND INSULATION/SPECIFICATION COMPLY WITH MANUFACTURERS RECOMMENDATIONS AND NZBC REGULATIONS. REFER TO INSITE WEBSITE FOR FULL TERMS AND CONDITIONS.

**LEGEND**

A	ENCLAD™ TERRACOTTA TILES
B	30mm - 32mm NOMINAL VENTILATION ZONE (AIR GAP)
C	* 82mm SYSTEM CAVITY TO ACCOMMODATE 50mm THICK INSULATION
D	* 50mm INSULATION (OPTION BY INSITE) FIRE STOP (OPTION BY INSITE)
*	OTHER OPTIONS AVAILABLE (PROJECT SPECIFIC) 105mm SYSTEM CAVITY FOR 75mm THICK INSULATION

Cladding Type :

**ENCLAD™ TERRACOTTA TILES - HORIZONTALLY LAID**

Support System :

**ENCLAD™ EN02 - HOOK ON SECRET FIXED**

Detail Description :

CAVITY SETOUT (PLAN VIEW)

Scale @ A3 : 1:2.5

Rev. : NOV 2022

System # :

TERRA-H-EN02-HOR-SF3

Detail # :

01

**ENCLAD™ RAINSCREEN SYSTEMS**



101 STATION ROAD, PENROSE,  
AUCKLAND 1061  
NEW ZEALAND

P: +64 9 307 1529  
www.insitefacades.co.nz

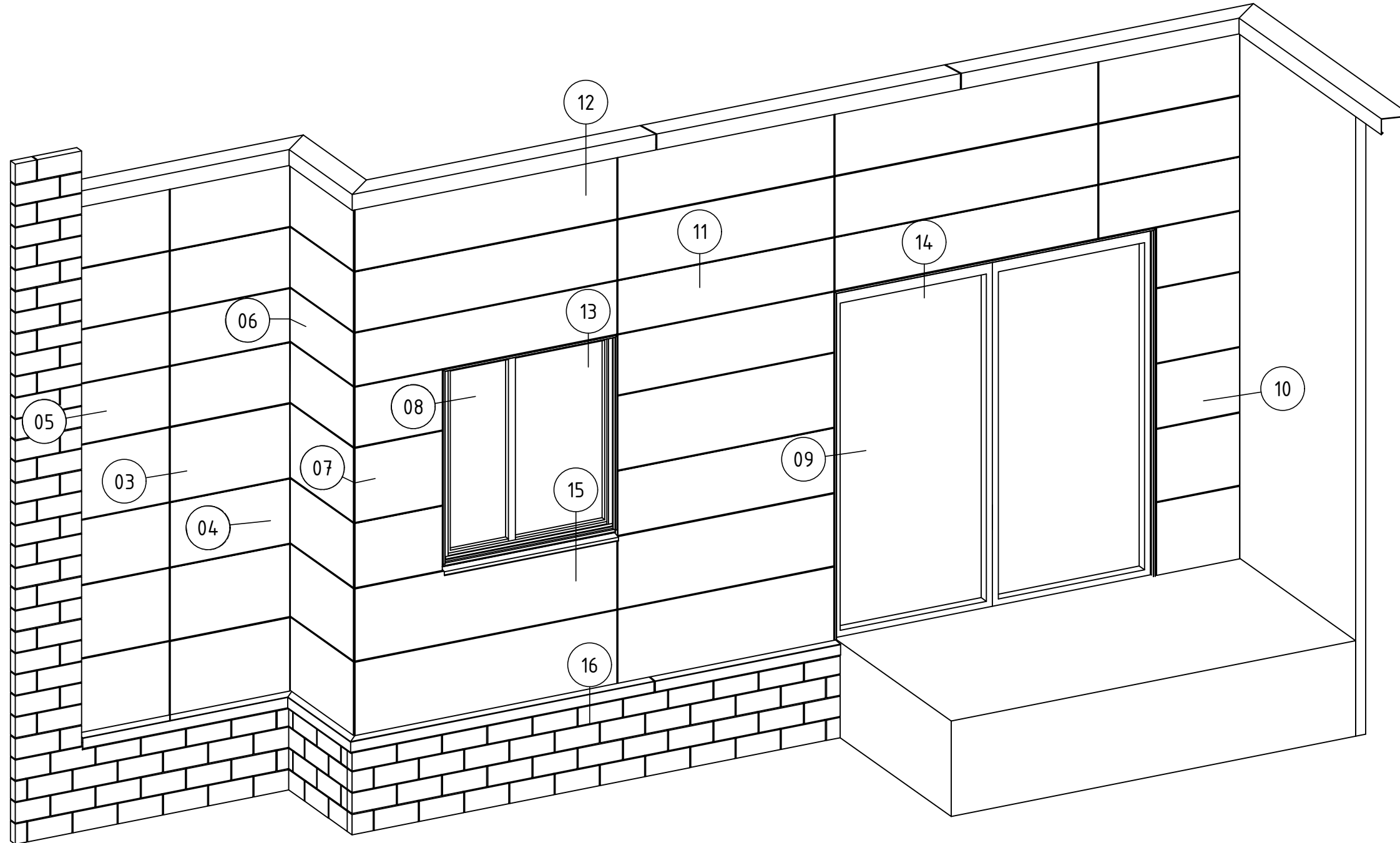

02 SCHEMATIC  
ENCLAD™ TERRACOTTA TILES

Cladding Type :  
**ENCLAD™ TERRACOTTA TILES - HORIZONTALLY LAID**

Support System :  
**ENCLAD™ EN02 - HOOK ON SECRET FIXED**

Detail Description :  
SCHEMATIC

Scale @ A3 : 1:5

Rev. : NOV 2022

System # :  
TERRA-H-EN02-HOR-SF3

Detail # :  
02

**ENCLAD™ RAINSCREEN SYSTEMS**

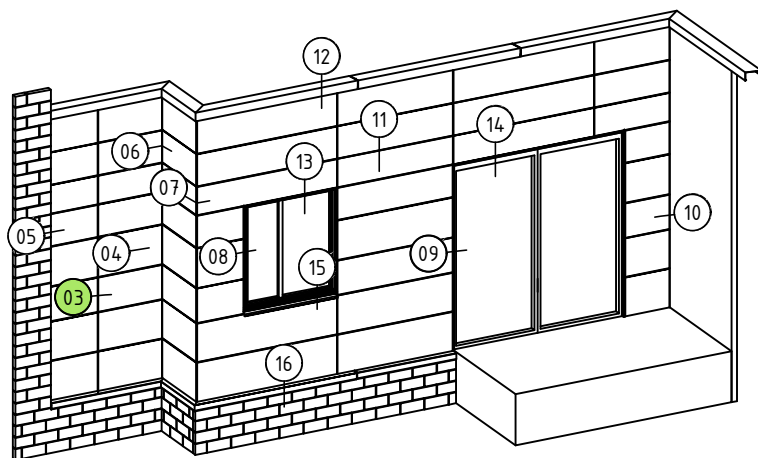
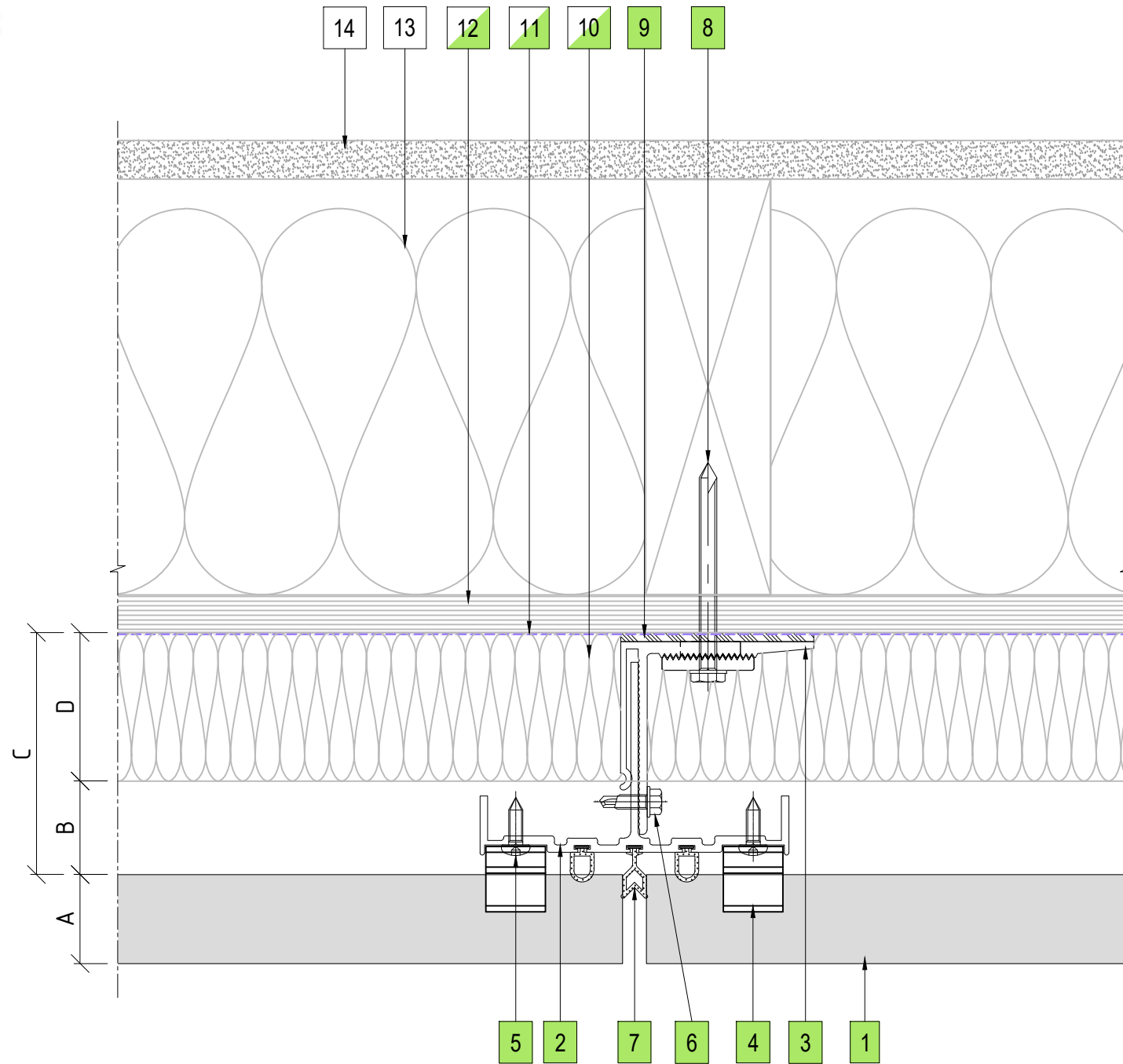

03 VERTICAL PANEL JOINT DETAIL  
ENCLAD™ TERRACOTTA TILES

**LEGEND**

A	ENCLAD™ TERRACOTTA TILES
B	30mm - 32mm NOMINAL VENTILATION ZONE (AIR GAP)
C	* 82mm SYSTEM CAVITY TO ACCOMMODATE 50mm THICK INSULATION
D	* 50mm INSULATION (OPTION BY INSITE) FIRE STOP (OPTION BY INSITE)
*	OTHER OPTIONS AVAILABLE (PROJECT SPECIFIC) 105mm SYSTEM CAVITY FOR 75mm THICK INSULATION

**PARTS LIST**

1	ENCLAD™ TERRACOTTA TILE
2	ENCLAD EN01 ALUMINIUM SUPPORT PROFILE
3	ENCLAD EN01 ALUMINIUM HELPING HAND BRACKET
4	ENCLAD EN01 ALUMINIUM TILE CLIP
5	ENCLAD CLIP FIXING (STAINLESS STEEL)
6	ENCLAD BRACKET TO RAIL FIXING (STAINLESS STEEL)
7	ENCLAD GASKET
8	ENCLAD HOST STRUCTURAL FIXING (STAINLESS STEEL)
9	ENCLAD THERMAL ISOLATION PAD
10	CAVITY INSULATION (OPTION BY INSITE)
11	BUILDING WRAP / MEMBRANE (OPTION BY INSITE)
12	RIGID AIR BARRIER / SHEATHING BOARD (OPTION BY INSITE)
13	WALL INSULATION (BY OTHERS)
14	PLASTER BOARD (BY OTHERS)

Cladding Type :

**ENCLAD™ TERRACOTTA TILES - HORIZONTALLY LAID**

Support System :

**ENCLAD™ EN02 - HOOK ON SECRET FIXED**

Detail Description :

**VERTICAL PANEL JOINT DETAIL (PLAN VIEW)**

Scale @ A3 : 1:2

Rev. : NOV 2022

System # :

**TERRA-H-EN02-HOR-SF3**

Detail # :

**03**

**ENCLAD™ RAINSCREEN SYSTEMS**

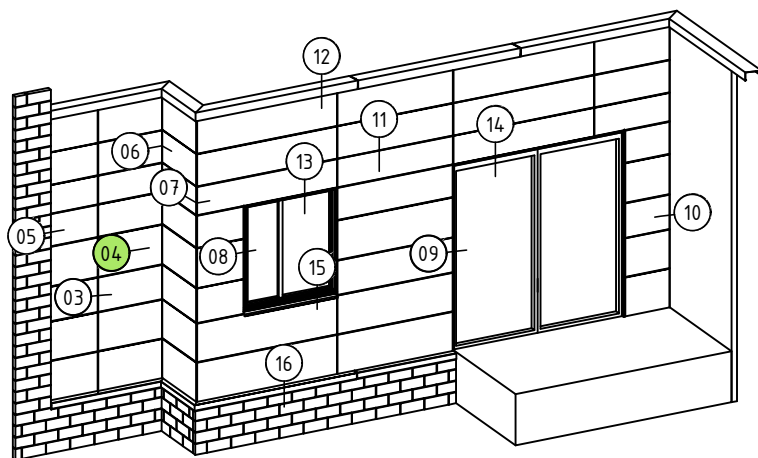
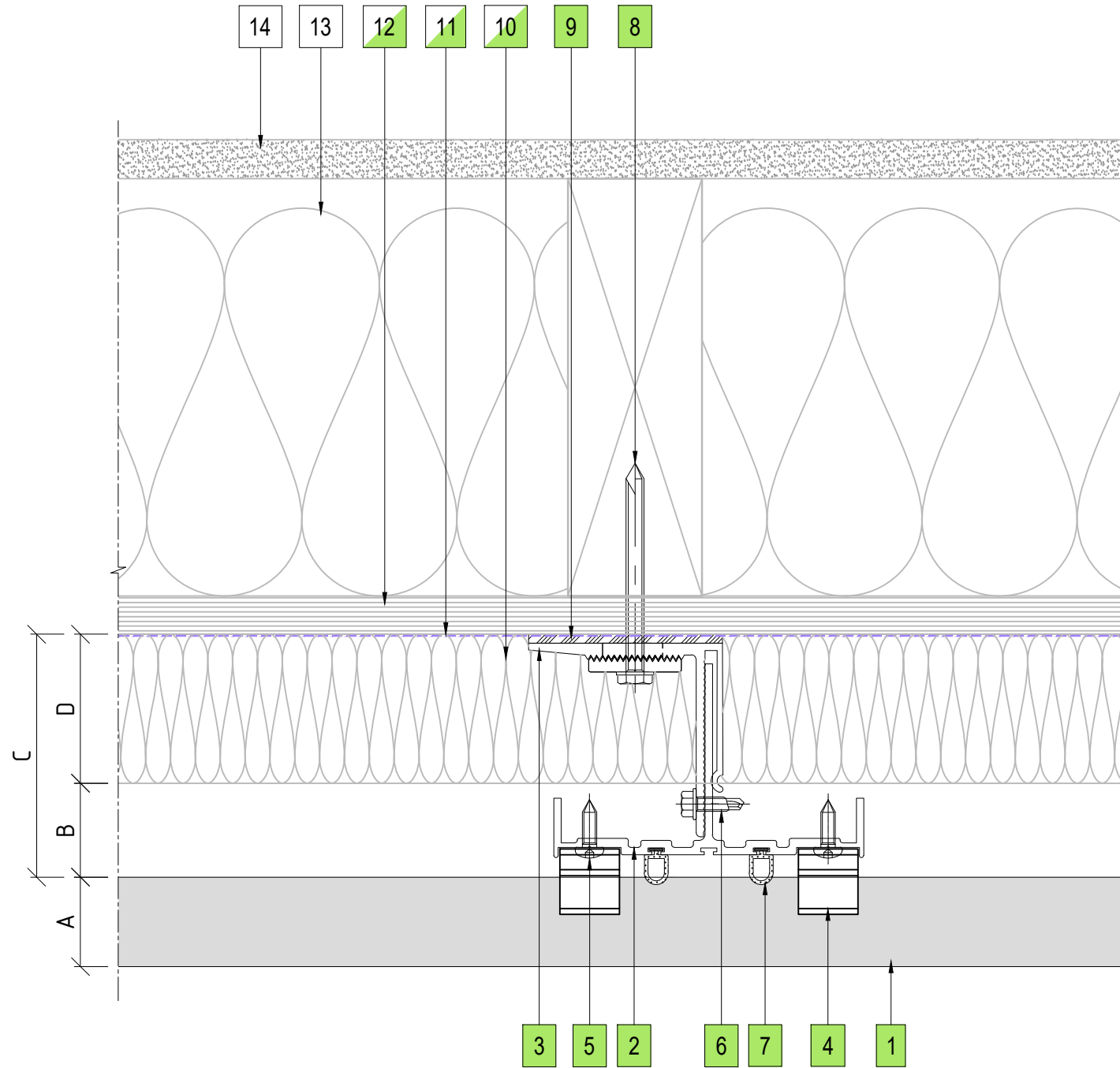

04 PANEL MID SUPPORT DETAIL  
ENCLAD™ TERRACOTTA TILES

**LEGEND**

A	ENCLAD™ TERRACOTTA TILES
B	30mm - 32mm NOMINAL VENTILATION ZONE (AIR GAP)
C	* 82mm SYSTEM CAVITY TO ACCOMMODATE 50mm THICK INSULATION
D	* 50mm INSULATION (OPTION BY INSITE) FIRE STOP (OPTION BY INSITE)
*	OTHER OPTIONS AVAILABLE (PROJECT SPECIFIC) 105mm SYSTEM CAVITY FOR 75mm THICK INSULATION

**PARTS LIST**

1	ENCLAD™ TERRACOTTA TILE
2	ENCLAD EN01 ALUMINIUM SUPPORT PROFILE
3	ENCLAD EN01 ALUMINIUM HELPING HAND BRACKET
4	ENCLAD EN01 ALUMINIUM TILE CLIP
5	ENCLAD CLIP FIXING (STAINLESS STEEL)
6	ENCLAD BRACKET TO RAIL FIXING (STAINLESS STEEL)
7	ENCLAD GASKET
8	ENCLAD HOST STRUCTURAL FIXING (STAINLESS STEEL)
9	ENCLAD THERMAL ISOLATION PAD
10	CAVITY INSULATION (OPTION BY INSITE)
11	BUILDING WRAP / MEMBRANE (OPTION BY INSITE)
12	RIGID AIR BARRIER / SHEATHING BOARD (OPTION BY INSITE)
13	WALL INSULATION (BY OTHERS)
14	PLASTER BOARD (BY OTHERS)

Cladding Type :

**ENCLAD™ TERRACOTTA TILES - HORIZONTALLY LAID**

Support System :

**ENCLAD™ EN02 - HOOK ON SECRET FIXED**

Detail Description :

PANEL MID SUPPORT DETAIL (PLAN VIEW)

Scale @ A3 : 1:2

Rev. : NOV 2022

System # :

TERRA-H-EN02-HOR-SF3

Detail # :

04

**ENCLAD™ RAINSCREEN SYSTEMS**



**LEGEND**

A	ENCLAD™ TERRACOTTA TILES
B	30mm - 32mm NOMINAL VENTILATION ZONE (AIR GAP)
C	* 82mm SYSTEM CAVITY TO ACCOMMODATE 50mm THICK INSULATION
D	* 50mm INSULATION (OPTION BY INSITE) FIRE STOP (OPTION BY INSITE)
*	OTHER OPTIONS AVAILABLE (PROJECT SPECIFIC) 105mm SYSTEM CAVITY FOR 75mm THICK INSULATION

**PARTS LIST**

1	ENCLAD™ TERRACOTTA TILE
2	ENCLAD EN01 ALUMINIUM SUPPORT PROFILE
3	ENCLAD EN01 ALUMINIUM HELPING HAND BRACKET
4	ENCLAD EN01 ALUMINIUM TILE CLIP
5	ENCLAD CLIP FIXING (STAINLESS STEEL)
6	ENCLAD BRACKET TO RAIL FIXING (STAINLESS STEEL)
7	ENCLAD GASKET
8	ENCLAD HOST STRUCTURAL FIXING (STAINLESS STEEL)
9	ENCLAD THERMAL ISOLATION PAD
10	ENCLAD ALUMINIUM CLOSURE
11	CAVITY INSULATION (OPTION BY INSITE)
12	BUILDING WRAP / MEMBRANE (OPTION BY INSITE)
13	RIGID AIR BARRIER / SHEATHING BOARD (OPTION BY INSITE)
14	WALL INSULATION (BY OTHERS)
15	PLASTER BOARD (BY OTHERS)

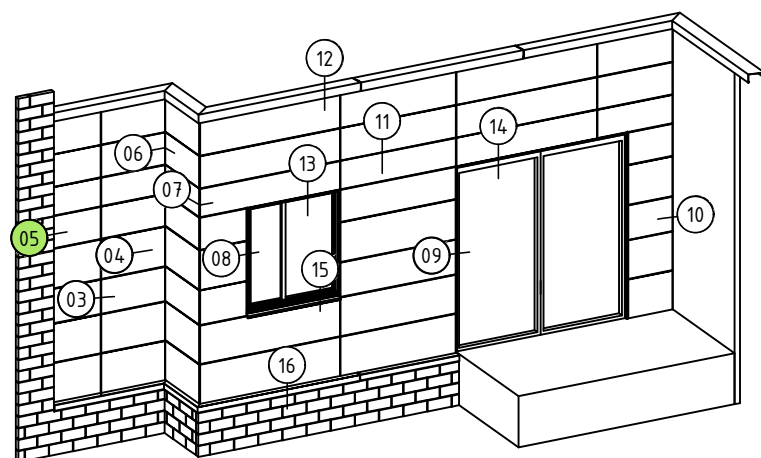
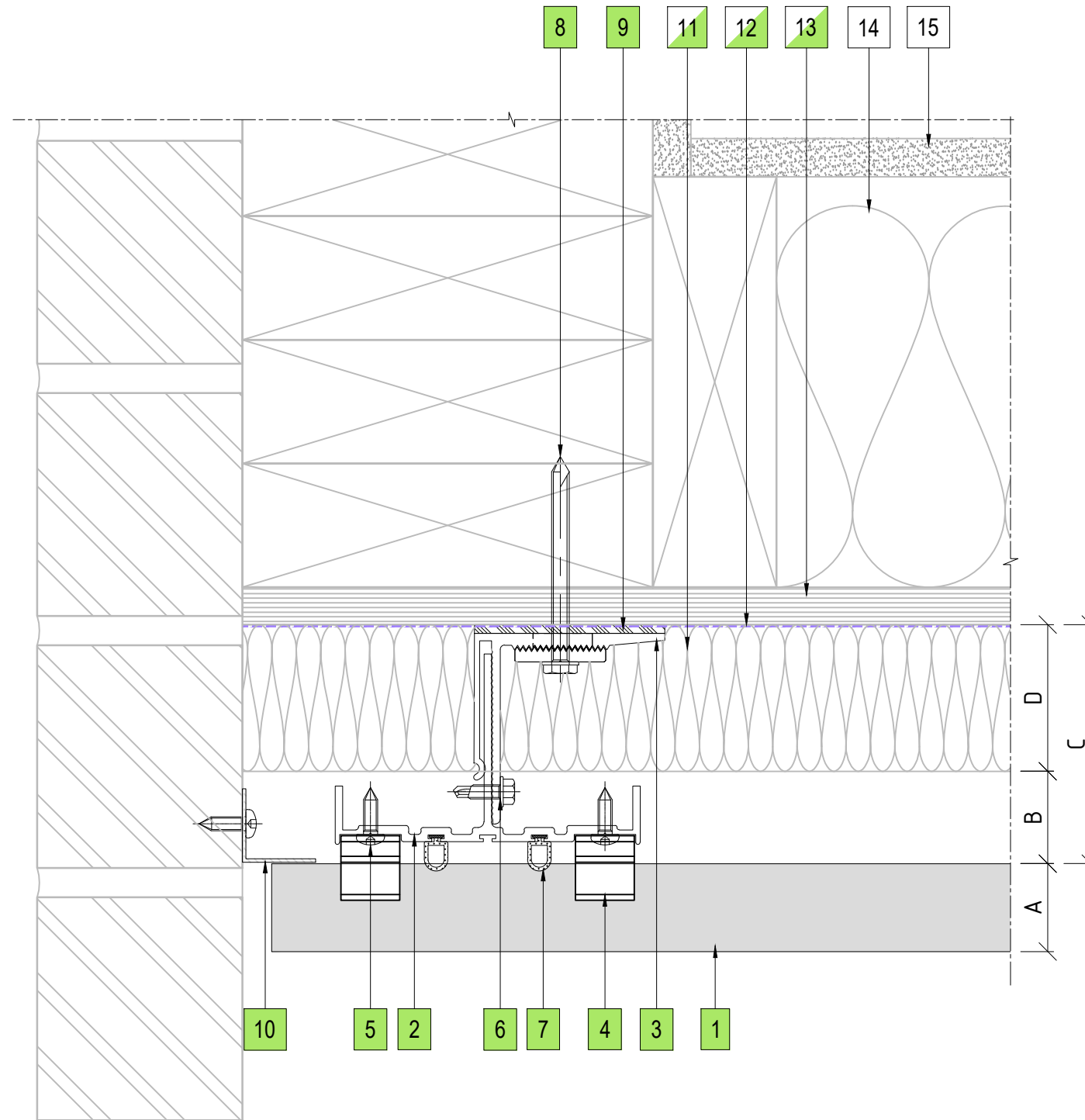

05 BRICKWALL ABUTMENT DETAIL  
ENCLAD™ TERRACOTTA TILES

Cladding Type :

**ENCLAD™ TERRACOTTA TILES - HORIZONTALLY LAID**

Support System :

**ENCLAD™ EN02 - HOOK ON SECRET FIXED**

Detail Description :

BRICKWALL ABUTMENT DETAIL (PLAN VIEW)

Scale @ A3 : 1:2

Rev. : NOV 2022

System # :

TERRA-H-EN02-HOR-SF3

Detail # :

05

**ENCLAD™ RAINSCREEN SYSTEMS**

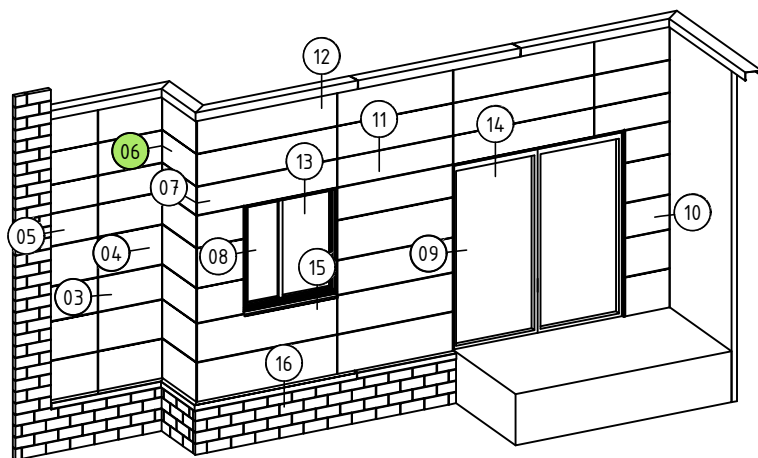
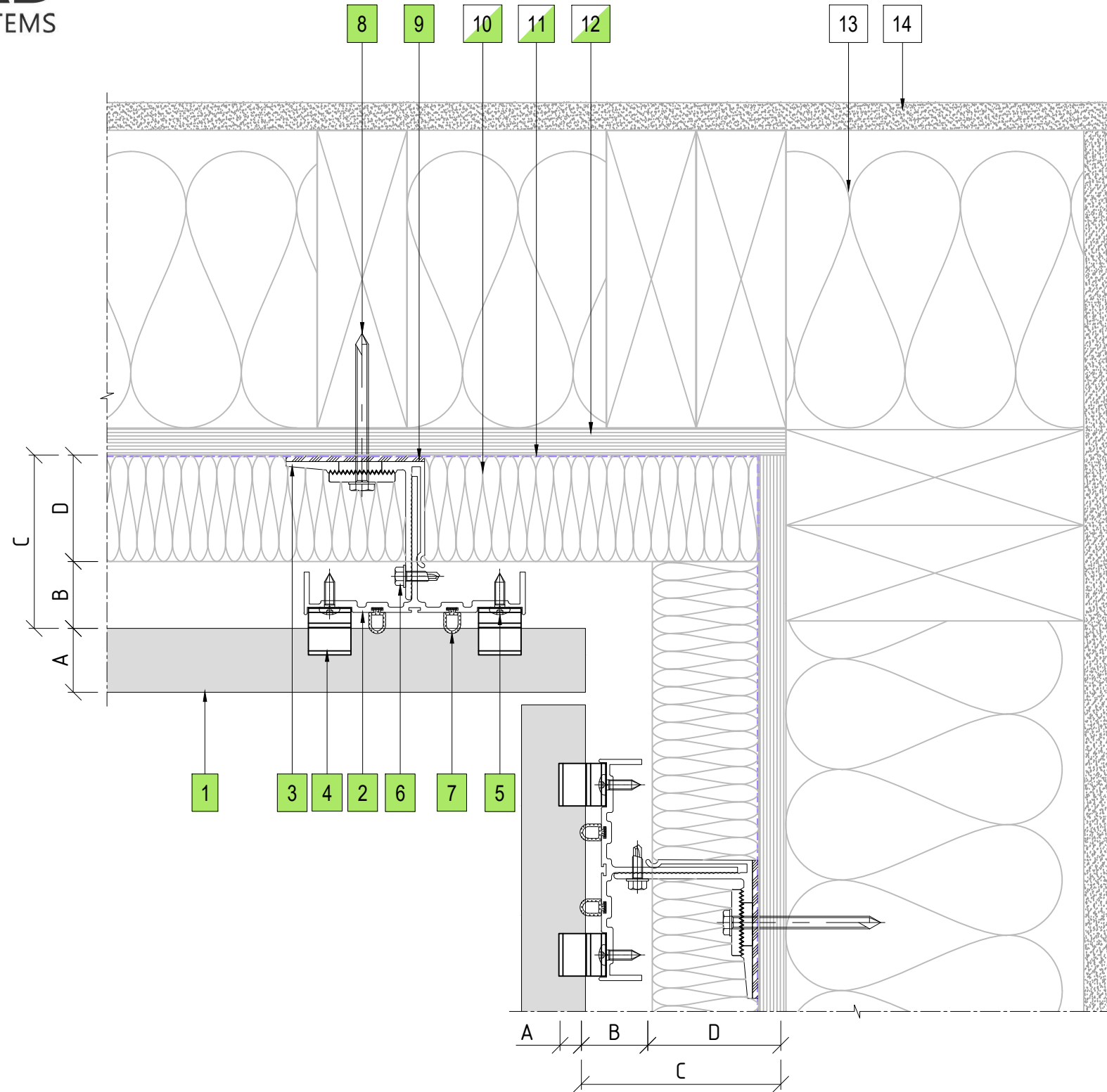

06 INTERNAL CORNER PANEL DETAIL  
ENCLAD<sup>TM</sup> TERRACOTTA TILES

**LEGEND**

A	ENCLAD <sup>TM</sup> TERRACOTTA TILES
B	30mm - 32mm NOMINAL VENTILATION ZONE (AIR GAP)
C	* 82mm SYSTEM CAVITY TO ACCOMMODATE 50mm THICK INSULATION
D	* 50mm INSULATION (OPTION BY INSITE) FIRE STOP (OPTION BY INSITE)
*	OTHER OPTIONS AVAILABLE (PROJECT SPECIFIC) 105mm SYSTEM CAVITY FOR 75mm THICK INSULATION

**PARTS LIST**

1	ENCLAD <sup>TM</sup> TERRACOTTA TILE
2	ENCLAD EN01 ALUMINIUM SUPPORT PROFILE
3	ENCLAD EN01 ALUMINIUM HELPING HAND BRACKET
4	ENCLAD EN01 ALUMINIUM TILE CLIP
5	ENCLAD CLIP FIXING (STAINLESS STEEL)
6	ENCLAD BRACKET TO RAIL FIXING (STAINLESS STEEL)
7	ENCLAD GASKET
8	ENCLAD HOST STRUCTURAL FIXING (STAINLESS STEEL)
9	ENCLAD THERMAL ISOLATION PAD
10	CAVITY INSULATION (OPTION BY INSITE)
11	BUILDING WRAP / MEMBRANE (OPTION BY INSITE)
12	RIGID AIR BARRIER / SHEATHING BOARD (OPTION BY INSITE)
13	WALL INSULATION (BY OTHERS)
14	PLASTER BOARD (BY OTHERS)

Cladding Type :

**ENCLAD<sup>TM</sup> TERRACOTTA TILES - HORIZONTALLY LAID**

Support System :

**ENCLAD<sup>TM</sup> EN02 - HOOK ON SECRET FIXED**

Detail Description :

INTERNAL CORNER PANEL DETAIL (PLAN VIEW)

Scale @ A3 : 1:2.5

Rev. : NOV 2022

System # :

TERRA-H-EN02-HOR-SF3

Detail # :

06

**ENCLAD<sup>TM</sup> RAINSCREEN SYSTEMS**

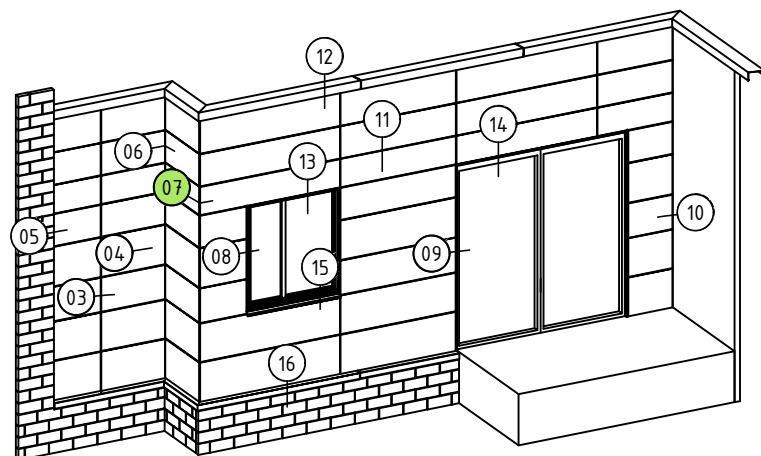
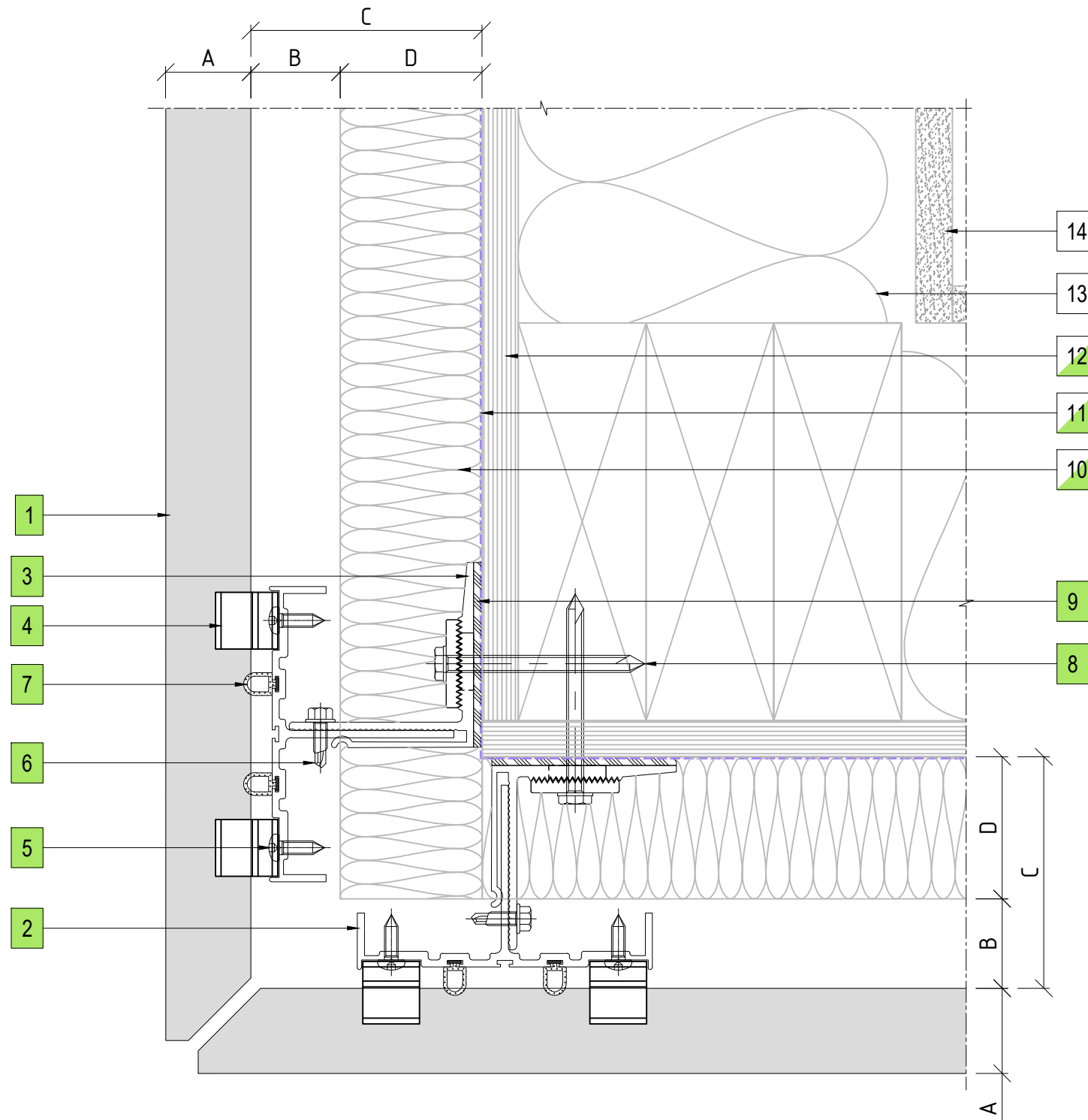

07 EXTERNAL CORNER PANEL DETAIL  
ENCLAD™ TERRACOTTA TILES

PART OF THE THERMOSASH GROUP COMPANIES :



**COPYRIGHT :** THESE DESIGNS, DETAILS AND/OR SPECIFICATIONS AND THE COPYRIGHT THEREIN, REMAIN THE PROPERTY OF INSITE FACADES LTD.

**DISCLAIMER :** THESE DETAILS ARE PROVIDED FOR INDICATIVE PURPOSES ONLY. CONSTRUCTION/SYSTEM DETAILS CAN VARY DEPENDING ON PROJECT SPECIFIC SPECIFICATION AND ENGINEERING REQUIREMENTS. THE DESIGNER IS RESPONSIBLE FOR ENSURING DETAILS SATISFY ALL NEW ZEALAND BUILDING CODE CLAUSES. THE DESIGNER IS RESPONSIBLE FOR ENSURING BUILDING WRAPS, FIRESTOPS AND INSULATION/SPECIFICATION COMPLY WITH MANUFACTURERS RECOMMENDATIONS AND NZBC REGULATIONS. REFER TO INSITE WEBSITE FOR FULL TERMS AND CONDITIONS.

**LEGEND**

A	ENCLAD™ TERRACOTTA TILES
B	30mm - 32mm NOMINAL VENTILATION ZONE (AIR GAP)
C	* 82mm SYSTEM CAVITY TO ACCOMMODATE 50mm THICK INSULATION
D	* 50mm INSULATION (OPTION BY INSITE) FIRE STOP (OPTION BY INSITE)
*	OTHER OPTIONS AVAILABLE (PROJECT SPECIFIC) 105mm SYSTEM CAVITY FOR 75mm THICK INSULATION

**PARTS LIST**

1	ENCLAD™ TERRACOTTA TILE
2	ENCLAD EN01 ALUMINIUM SUPPORT PROFILE
3	ENCLAD EN01 ALUMINIUM HELPING HAND BRACKET
4	ENCLAD EN01 ALUMINIUM TILE CLIP
5	ENCLAD CLIP FIXING (STAINLESS STEEL)
6	ENCLAD BRACKET TO RAIL FIXING (STAINLESS STEEL)
7	ENCLAD GASKET
8	ENCLAD HOST STRUCTURAL FIXING (STAINLESS STEEL)
9	ENCLAD THERMAL ISOLATION PAD
10	CAVITY INSULATION (OPTION BY INSITE)
11	BUILDING WRAP / MEMBRANE (OPTION BY INSITE)
12	RIGID AIR BARRIER / SHEATHING BOARD (OPTION BY INSITE)
13	WALL INSULATION (BY OTHERS)
14	PLASTER BOARD (BY OTHERS)

Cladding Type :  
**ENCLAD™ TERRACOTTA TILES - HORIZONTALLY LAID**

Support System :  
**ENCLAD™ EN02 - HOOK ON SECRET FIXED**

Detail Description :  
EXTERNAL CORNER PANEL DETAIL (PLAN VIEW)

Scale @ A3 : 1:2	Rev. : NOV 2022
System # : TERRA-H-EN02-HOR-SF3	Detail # : 07

**ENCLAD™ RAINSCREEN SYSTEMS**



101 STATION ROAD, PENROSE,  
AUCKLAND 1061  
NEW ZEALAND

P: +64 9 307 1529  
www.insitefacades.co.nz



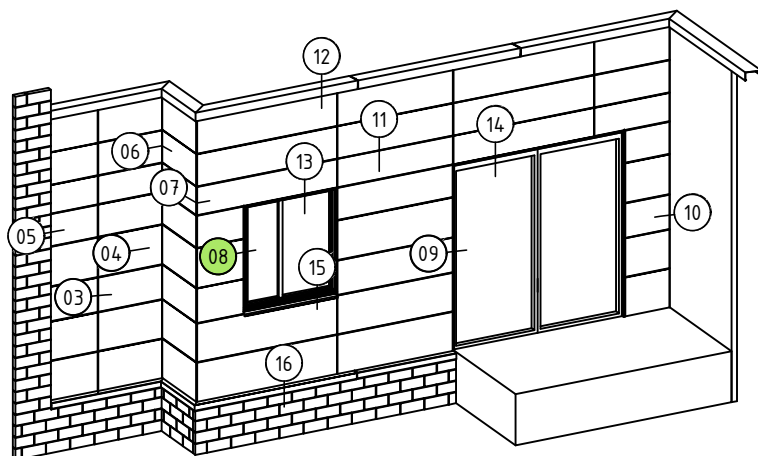
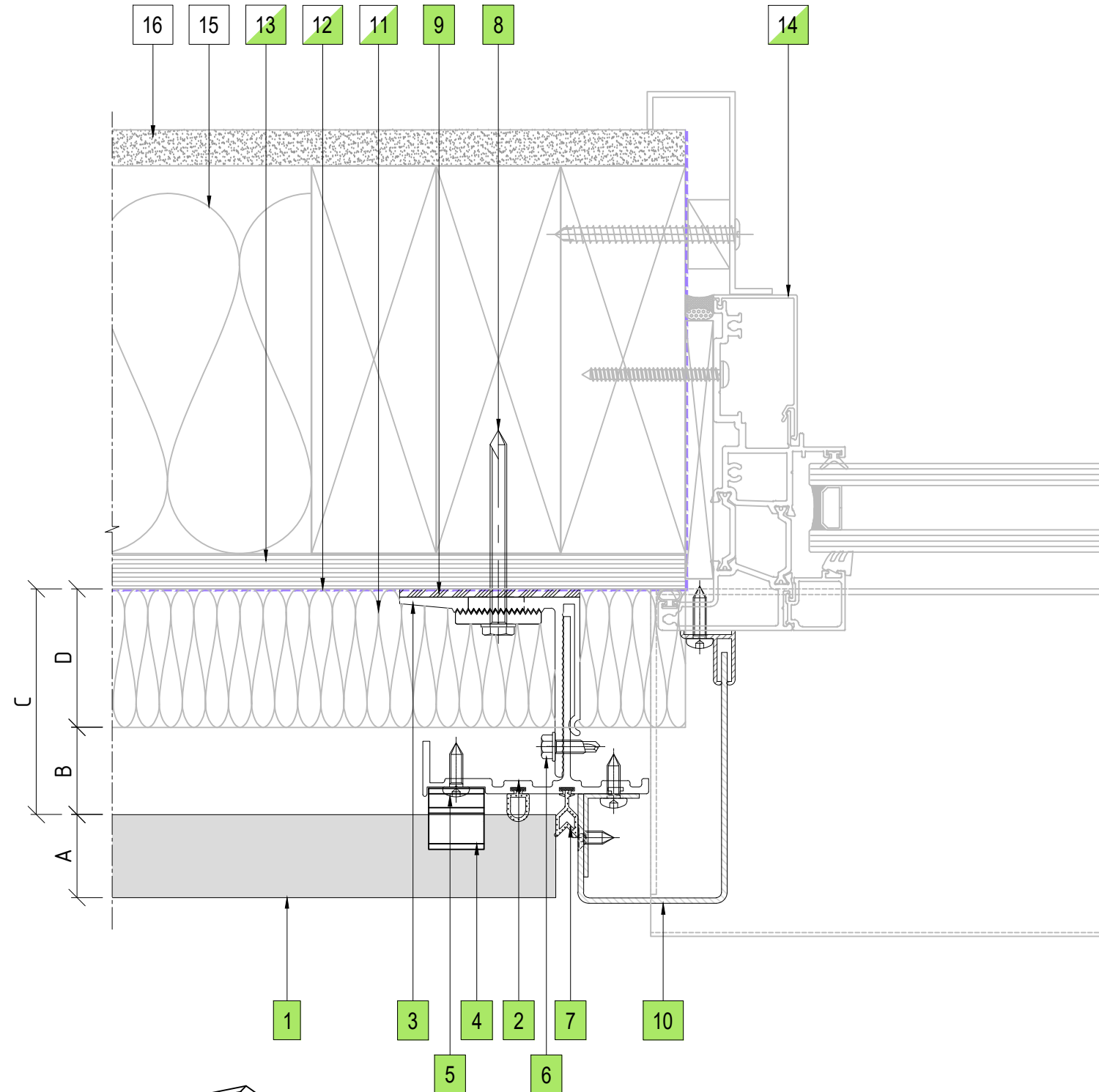

08 WINDOW JAMB DETAIL  
ENCLAD™ TERRACOTTA TILES

**LEGEND**

A	ENCLAD™ TERRACOTTA TILES
B	30mm - 32mm NOMINAL VENTILATION ZONE (AIR GAP)
C	* 82mm SYSTEM CAVITY TO ACCOMMODATE 50mm THICK INSULATION
D	* 50mm INSULATION (OPTION BY INSITE) FIRE STOP (OPTION BY INSITE)
*	OTHER OPTIONS AVAILABLE (PROJECT SPECIFIC) 105mm SYSTEM CAVITY FOR 75mm THICK INSULATION

**PARTS LIST**

1	ENCLAD™ TERRACOTTA TILE
2	ENCLAD EN01 ALUMINIUM SUPPORT PROFILE
3	ENCLAD EN01 ALUMINIUM HELPING HAND BRACKET
4	ENCLAD EN01 ALUMINIUM TILE CLIP
5	ENCLAD CLIP FIXING (STAINLESS STEEL)
6	ENCLAD BRACKET TO RAIL FIXING (STAINLESS STEEL)
7	ENCLAD GASKET
8	ENCLAD HOST STRUCTURAL FIXING (STAINLESS STEEL)
9	ENCLAD THERMAL ISOLATION PAD
10	ENCLAD ALUMINIUM CLOSURE
11	CAVITY INSULATION (OPTION BY INSITE)
12	BUILDING WRAP / MEMBRANE (OPTION BY INSITE)
13	RIGID AIR BARRIER / SHEATHING BOARD (OPTION BY INSITE)
14	ALUMINIUM DOORS, WINDOWS & REVEALS (OPTION BY INSITE)
15	WALL INSULATION (BY OTHERS)
16	PLASTER BOARD (BY OTHERS)

Cladding Type :

**ENCLAD™ TERRACOTTA TILES - HORIZONTALLY LAID**

Support System :

**ENCLAD™ EN02 - HOOK ON SECRET FIXED**

Detail Description :

WINDOW JAMB DETAIL (PLAN VIEW)

Scale @ A3 : 1:2

Rev. : NOV 2022

System # :

TERRA-H-EN02-HOR-SF3

Detail # :

08

**ENCLAD™ RAINSCREEN SYSTEMS**

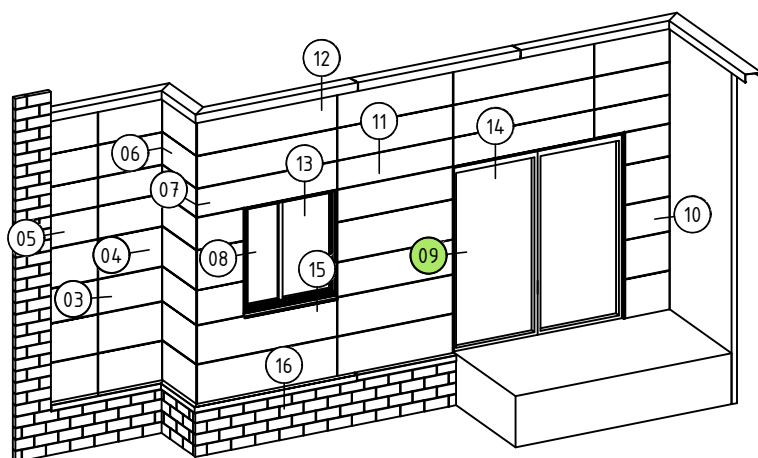
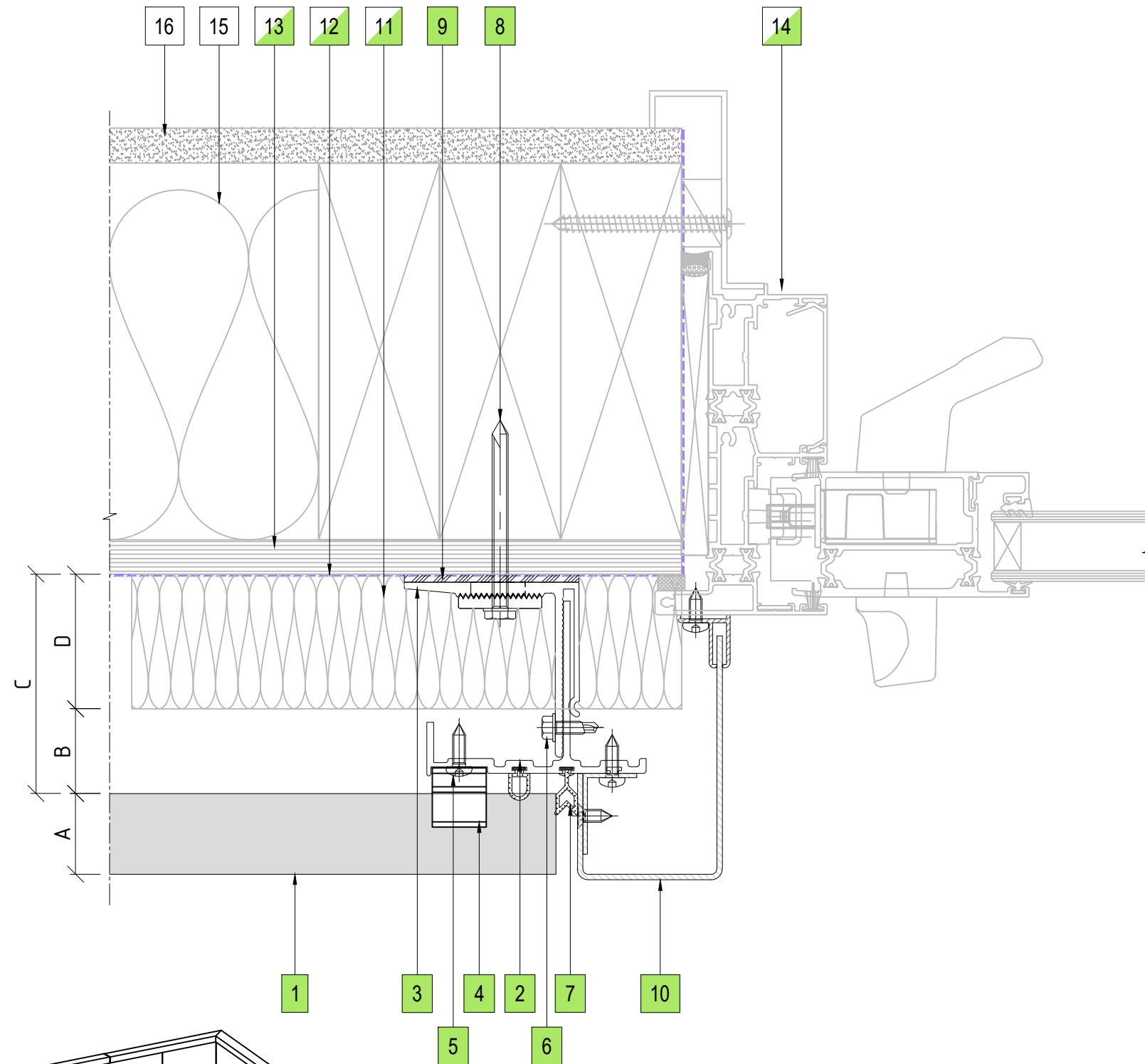

09 DOOR JAMB DETAIL  
ENCLAD™ TERRACOTTA TILES

**LEGEND**

A	ENCLAD™ TERRACOTTA TILES
B	30mm - 32mm NOMINAL VENTILATION ZONE (AIR GAP)
C	* 82mm SYSTEM CAVITY TO ACCOMMODATE 50mm THICK INSULATION
D	* 50mm INSULATION (OPTION BY INSITE) FIRE STOP (OPTION BY INSITE)
*	OTHER OPTIONS AVAILABLE (PROJECT SPECIFIC) 105mm SYSTEM CAVITY FOR 75mm THICK INSULATION

**PARTS LIST**

1	ENCLAD™ TERRACOTTA TILE
2	ENCLAD EN01 ALUMINIUM SUPPORT PROFILE
3	ENCLAD EN01 ALUMINIUM HELPING HAND BRACKET
4	ENCLAD EN01 ALUMINIUM TILE CLIP
5	ENCLAD CLIP FIXING (STAINLESS STEEL)
6	ENCLAD BRACKET TO RAIL FIXING (STAINLESS STEEL)
7	ENCLAD GASKET
8	ENCLAD HOST STRUCTURAL FIXING (STAINLESS STEEL)
9	ENCLAD THERMAL ISOLATION PAD
10	ENCLAD ALUMINIUM CLOSURE
11	CAVITY INSULATION (OPTION BY INSITE)
12	BUILDING WRAP / MEMBRANE (OPTION BY INSITE)
13	RIGID AIR BARRIER / SHEATHING BOARD (OPTION BY INSITE)
14	ALUMINIUM DOORS, WINDOWS & REVEALS (OPTION BY INSITE)
15	WALL INSULATION (BY OTHERS)
16	PLASTER BOARD (BY OTHERS)

Cladding Type :

**ENCLAD™ TERRACOTTA TILES - HORIZONTALLY LAID**

Support System :

**ENCLAD™ EN02 - HOOK ON SECRET FIXED**

Detail Description :

DOOR JAMB DETAIL (PLAN VIEW)

Scale @ A3 : 1:2

Rev. : NOV 2022

System # :

TERRA-H-EN02-HOR-SF3

Detail # :

09

**ENCLAD™ RAINSCREEN SYSTEMS**

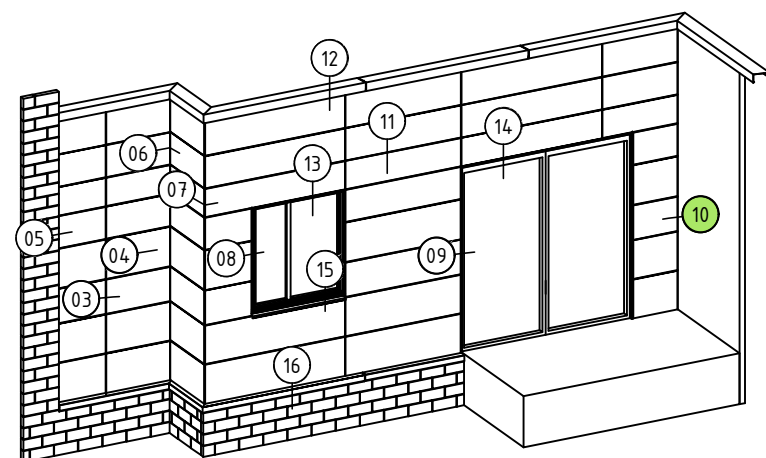
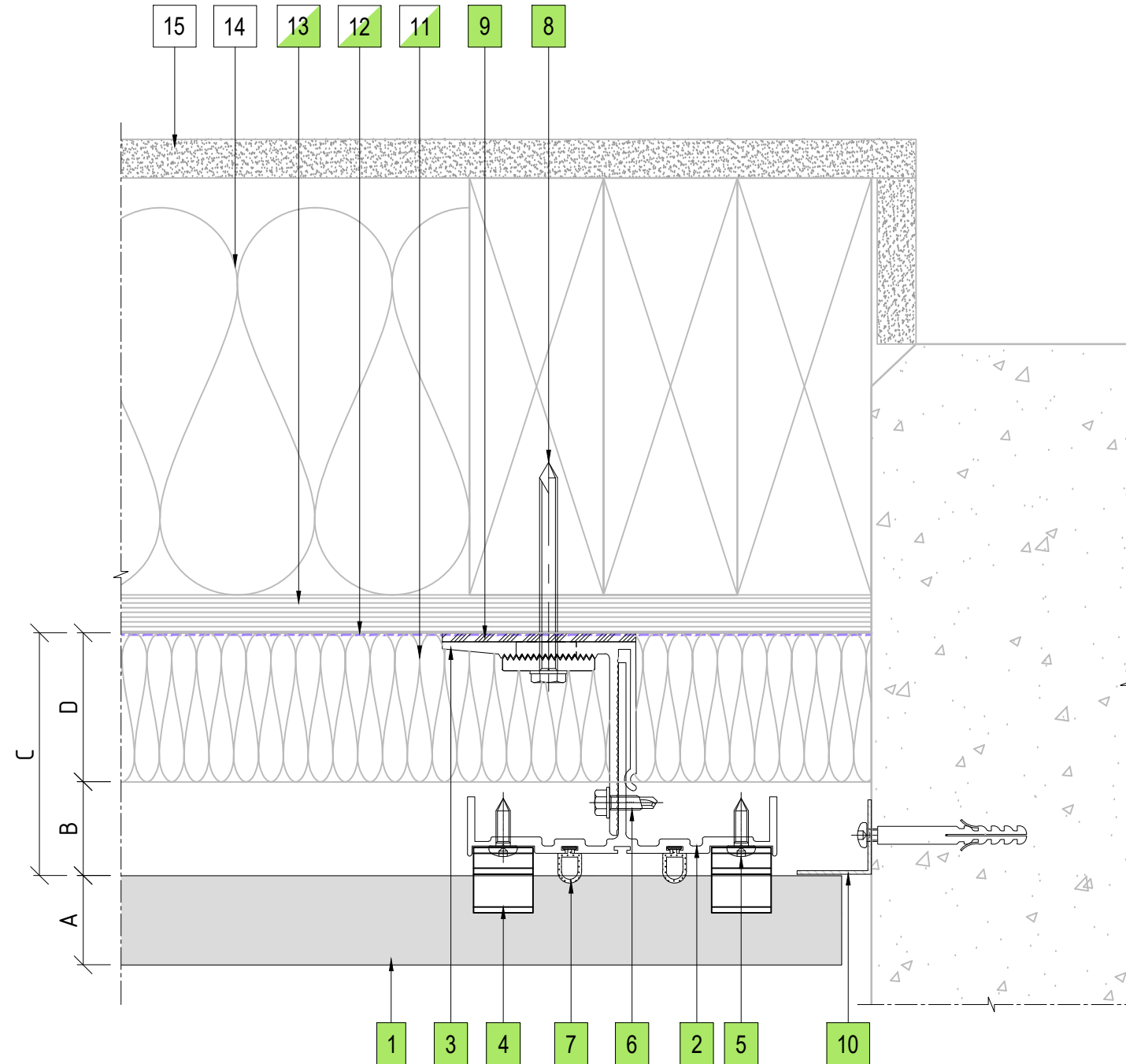

10 CONCRETE WALL ABUTMENT DETAIL  
ENCLAD™ TERRACOTTA TILES

**LEGEND**

A	ENCLAD™ TERRACOTTA TILES
B	30mm - 32mm NOMINAL VENTILATION ZONE (AIR GAP)
C	* 82mm SYSTEM CAVITY TO ACCOMMODATE 50mm THICK INSULATION
D	* 50mm INSULATION (OPTION BY INSITE) FIRE STOP (OPTION BY INSITE)
*	OTHER OPTIONS AVAILABLE (PROJECT SPECIFIC) 105mm SYSTEM CAVITY FOR 75mm THICK INSULATION

**PARTS LIST**

1	ENCLAD™ TERRACOTTA TILE
2	ENCLAD EN01 ALUMINIUM SUPPORT PROFILE
3	ENCLAD EN01 ALUMINIUM HELPING HAND BRACKET
4	ENCLAD EN01 ALUMINIUM TILE CLIP
5	ENCLAD CLIP FIXING (STAINLESS STEEL)
6	ENCLAD BRACKET TO RAIL FIXING (STAINLESS STEEL)
7	ENCLAD GASKET
8	ENCLAD HOST STRUCTURAL FIXING (STAINLESS STEEL)
9	ENCLAD THERMAL ISOLATION PAD
10	ENCLAD ALUMINIUM CLOSURE
11	CAVITY INSULATION (OPTION BY INSITE)
12	BUILDING WRAP / MEMBRANE (OPTION BY INSITE)
13	RIGID AIR BARRIER / SHEATHING BOARD (OPTION BY INSITE)
14	WALL INSULATION (BY OTHERS)
15	PLASTER BOARD (BY OTHERS)

Cladding Type :

**ENCLAD™ TERRACOTTA TILES - HORIZONTALLY LAID**

Support System :

**ENCLAD™ EN02 - HOOK ON SECRET FIXED**

Detail Description :

CONCRETE WALL ABUTMENT DETAIL (PLAN VIEW)

Scale @ A3 : 1:2

Rev. : NOV 2022

System # :

TERRA-H-EN02-HOR-SF3

Detail # :

10

**ENCLAD™ RAINSCREEN SYSTEMS**

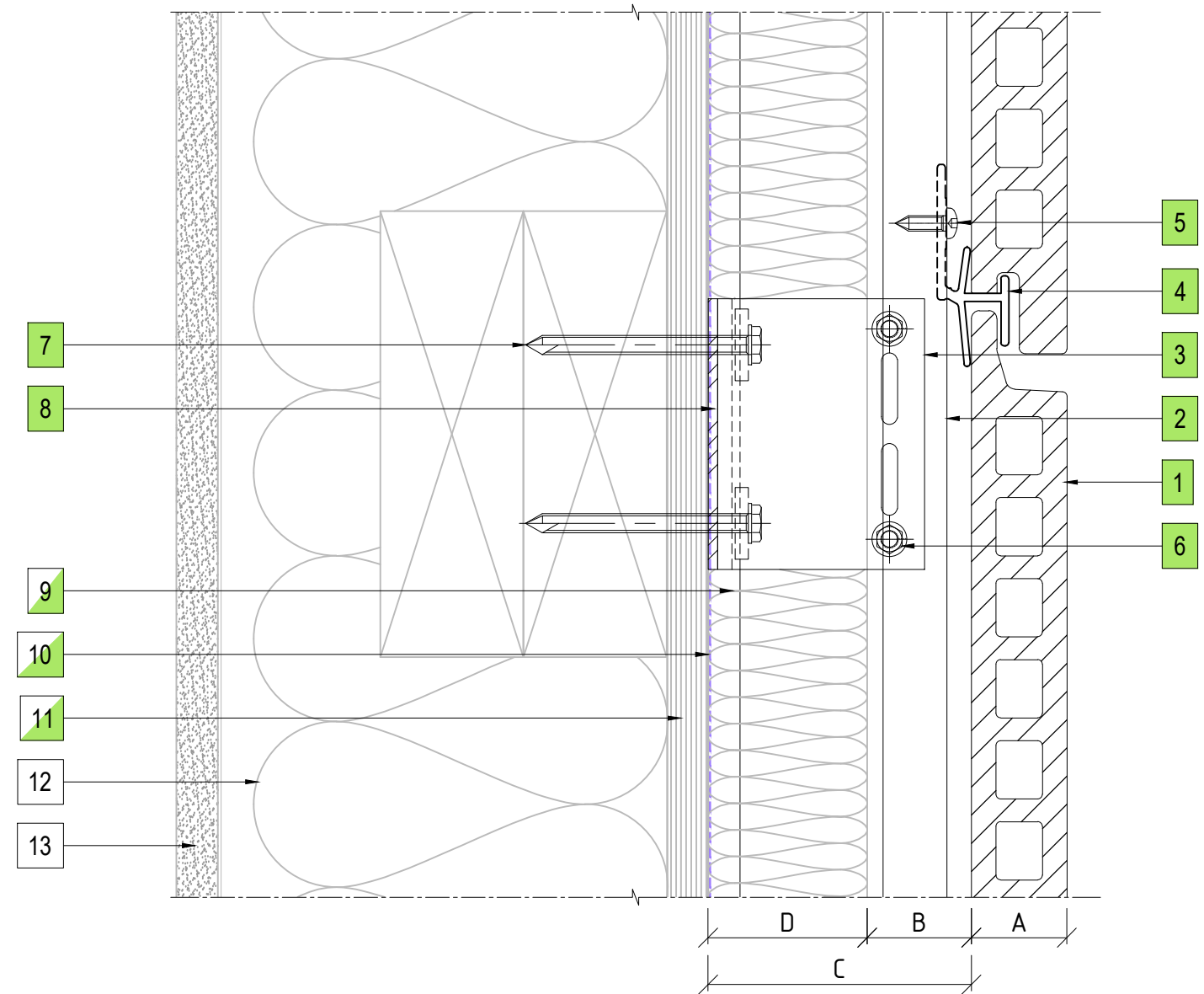

**LEGEND**

A	ENCLAD™ TERRACOTTA TILES
B	30mm - 32mm NOMINAL VENTILATION ZONE (AIR GAP)
C	* 82mm SYSTEM CAVITY TO ACCOMMODATE 50mm THICK INSULATION
D	* 50mm INSULATION (OPTION BY INSITE) FIRE STOP (OPTION BY INSITE)
*	OTHER OPTIONS AVAILABLE (PROJECT SPECIFIC) 105mm SYSTEM CAVITY FOR 75mm THICK INSULATION

**PARTS LIST**

1	ENCLAD™ TERRACOTTA TILE
2	ENCLAD EN01 ALUMINIUM SUPPORT PROFILE
3	ENCLAD EN01 ALUMINIUM HELPING HAND BRACKET
4	ENCLAD EN01 ALUMINIUM TILE CLIP
5	ENCLAD CLIP FIXING (STAINLESS STEEL)
6	ENCLAD BRACKET TO RAIL FIXING (STAINLESS STEEL)
7	ENCLAD HOST STRUCTURAL FIXING (STAINLESS STEEL)
8	ENCLAD THERMAL ISOLATION PAD
9	CAVITY INSULATION (OPTION BY INSITE)
10	BUILDING WRAP / MEMBRANE (OPTION BY INSITE)
11	RIGID AIR BARRIER / SHEATHING BOARD (OPTION BY INSITE)
12	WALL INSULATION (BY OTHERS)
13	PLASTER BOARD (BY OTHERS)

Cladding Type :  
**ENCLAD™ TERRACOTTA TILES - HORIZONTALLY LAID**

Support System :  
**ENCLAD™ EN02 - HOOK ON SECRET FIXED**

Detail Description :  
**HORIZONTAL PANEL JOINT DETAIL (SECTION VIEW)**

Scale @ A3 : 1:2	Rev. : NOV 2022
System # : TERRA-H-EN02-HOR-SF3	Detail # : <b>11</b>

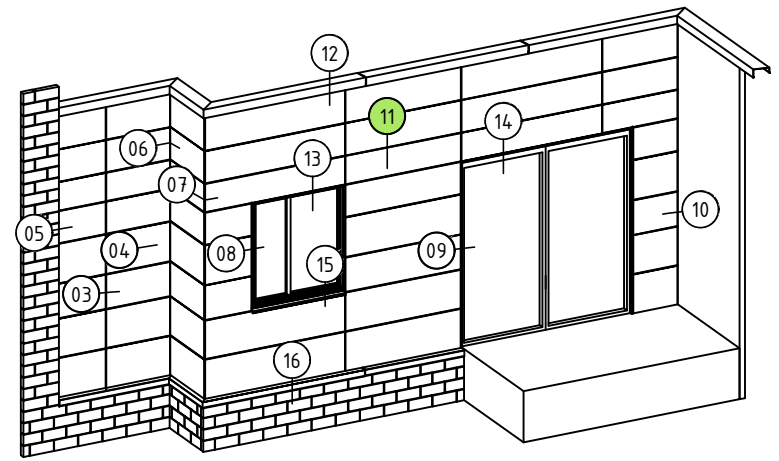

**11** HORIZONTAL PANEL JOINT DETAIL  
ENCLAD™ TERRACOTTA TILES

**LEGEND**

A	ENCLAD™ TERRACOTTA TILES
B	30mm - 32mm NOMINAL VENTILATION ZONE (AIR GAP)
C	* 82mm SYSTEM CAVITY TO ACCOMMODATE 50mm THICK INSULATION
D	* 50mm INSULATION (OPTION BY INSITE) FIRE STOP (OPTION BY INSITE)
*	OTHER OPTIONS AVAILABLE (PROJECT SPECIFIC) 105mm SYSTEM CAVITY FOR 75mm THICK INSULATION

**PARTS LIST**

1	ENCLAD™ TERRACOTTA TILE
2	ENCLAD EN01 ALUMINIUM SUPPORT PROFILE
3	ENCLAD EN01 ALUMINIUM HELPING HAND BRACKET
4	ENCLAD EN01 ALUMINIUM TILE CLIP
5	ENCLAD CLIP FIXING (STAINLESS STEEL)
6	ENCLAD BRACKET TO RAIL FIXING (STAINLESS STEEL)
7	ENCLAD HOST STRUCTURAL FIXING (STAINLESS STEEL)
8	ENCLAD THERMAL ISOLATION PAD
9	ENCLAD ALUMINIUM FLASHING
10	ENCLAD ALUMINIUM BRACKET
11	CAVITY INSULATION (OPTION BY INSITE)
12	BUILDING WRAP / MEMBRANE (OPTION BY INSITE)
13	RIGID AIR BARRIER / SHEATHING BOARD (OPTION BY INSITE)
14	WALL INSULATION (BY OTHERS)
15	PLASTER BOARD (BY OTHERS)

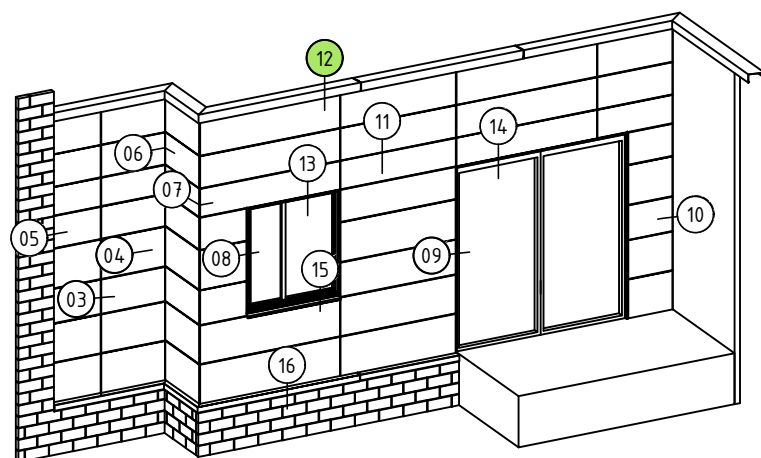
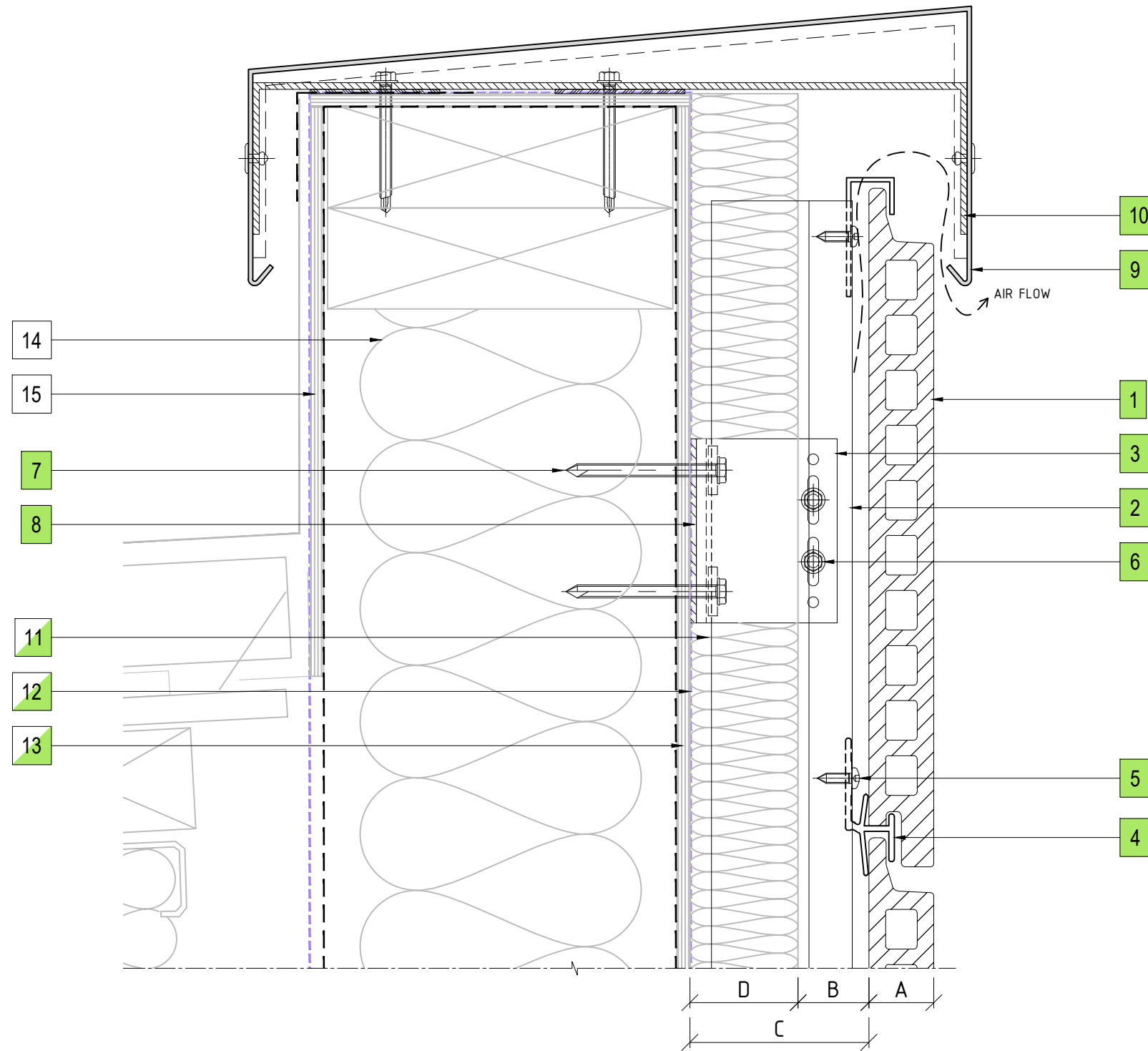

12 PARAPET FLASHING DETAIL  
ENCLAD™ TERRACOTTA TILES

Cladding Type :

**ENCLAD™ TERRACOTTA TILES -  
HORIZONTALLY LAID**

Support System :

**ENCLAD™ EN02 - HOOK ON SECRET FIXED**

Detail Description :

PARAPET FLASHING DETAIL (SECTION VIEW)

Scale @ A3 : 1:2.5

Rev. : NOV 2022

System # :

TERRA-H-EN02-HOR-SF3

Detail # :

12

**ENCLAD™ RAINSCREEN SYSTEMS**



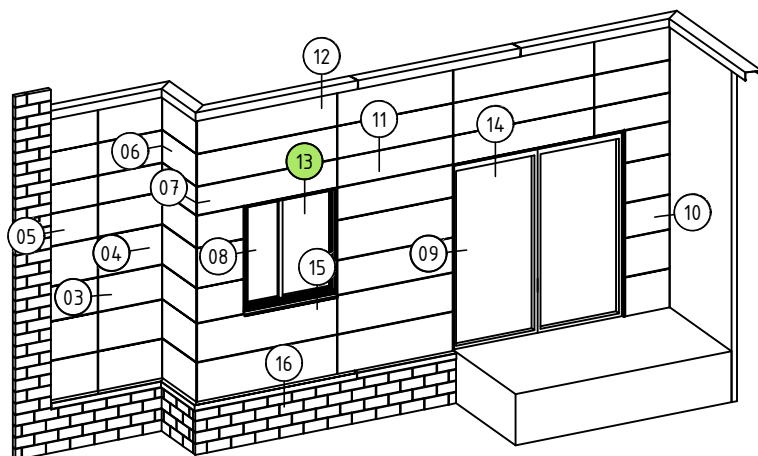
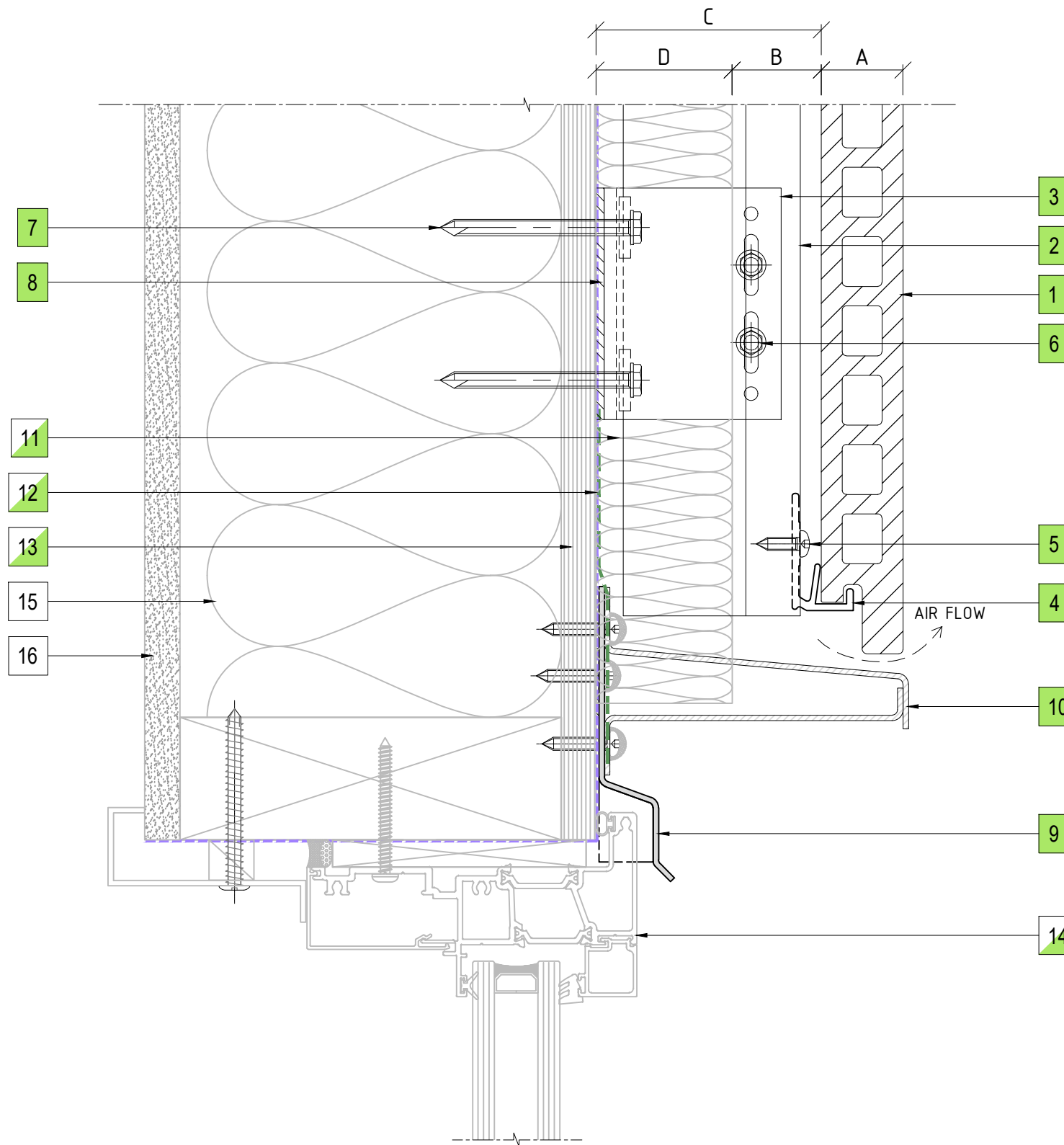

13 WINDOW HEAD DETAIL  
ENCLAD™ TERRACOTTA TILES

**LEGEND**

A	ENCLAD™ TERRACOTTA TILES
B	30mm - 32mm NOMINAL VENTILATION ZONE (AIR GAP)
C	* 82mm SYSTEM CAVITY TO ACCOMMODATE 50mm THICK INSULATION
D	* 50mm INSULATION (OPTION BY INSITE) FIRE STOP (OPTION BY INSITE)
*	OTHER OPTIONS AVAILABLE (PROJECT SPECIFIC) 105mm SYSTEM CAVITY FOR 75mm THICK INSULATION

**PARTS LIST**

1	ENCLAD™ TERRACOTTA TILE
2	ENCLAD EN01 ALUMINIUM SUPPORT PROFILE
3	ENCLAD EN01 ALUMINIUM HELPING HAND BRACKET
4	ENCLAD EN01 ALUMINIUM TILE CLIP
5	ENCLAD CLIP FIXING (STAINLESS STEEL)
6	ENCLAD BRACKET TO RAIL FIXING (STAINLESS STEEL)
7	ENCLAD HOST STRUCTURAL FIXING (STAINLESS STEEL)
8	ENCLAD THERMAL ISOLATION PAD
9	ENCLAD ALUMINIUM FLASHING
10	ENCLAD ALUMINIUM CLOSURE
11	CAVITY INSULATION (OPTION BY INSITE)
12	BUILDING WRAP / MEMBRANE (OPTION BY INSITE)
13	RIGID AIR BARRIER / SHEATHING BOARD (OPTION BY INSITE)
14	ALUMINIUM DOORS, WINDOWS & REVEALS (OPTION BY INSITE)
15	WALL INSULATION (BY OTHERS)
16	PLASTER BOARD (BY OTHERS)

Cladding Type :

**ENCLAD™ TERRACOTTA TILES - HORIZONTALLY LAID**

Support System :

**ENCLAD™ EN02 - HOOK ON SECRET FIXED**

Detail Description :

WINDOW HEAD DETAIL (SECTION VIEW)

Scale @ A3 : 1:2

Rev. : NOV 2022

System # :

TERRA-H-EN02-HOR-SF3

Detail # :

13

**ENCLAD™ RAINSCREEN SYSTEMS**

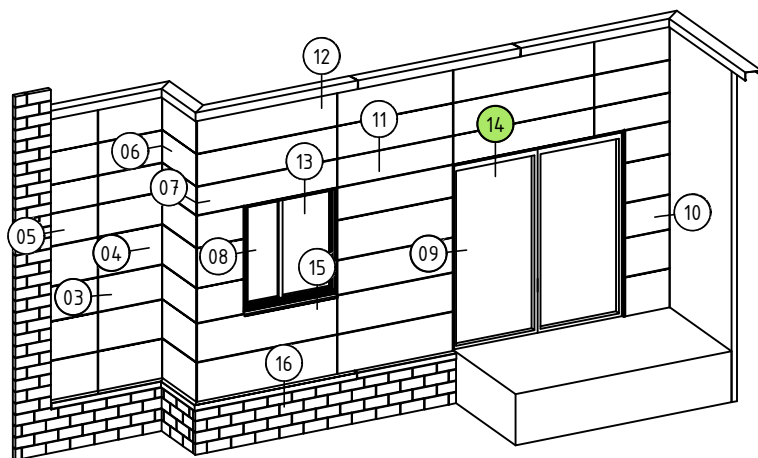
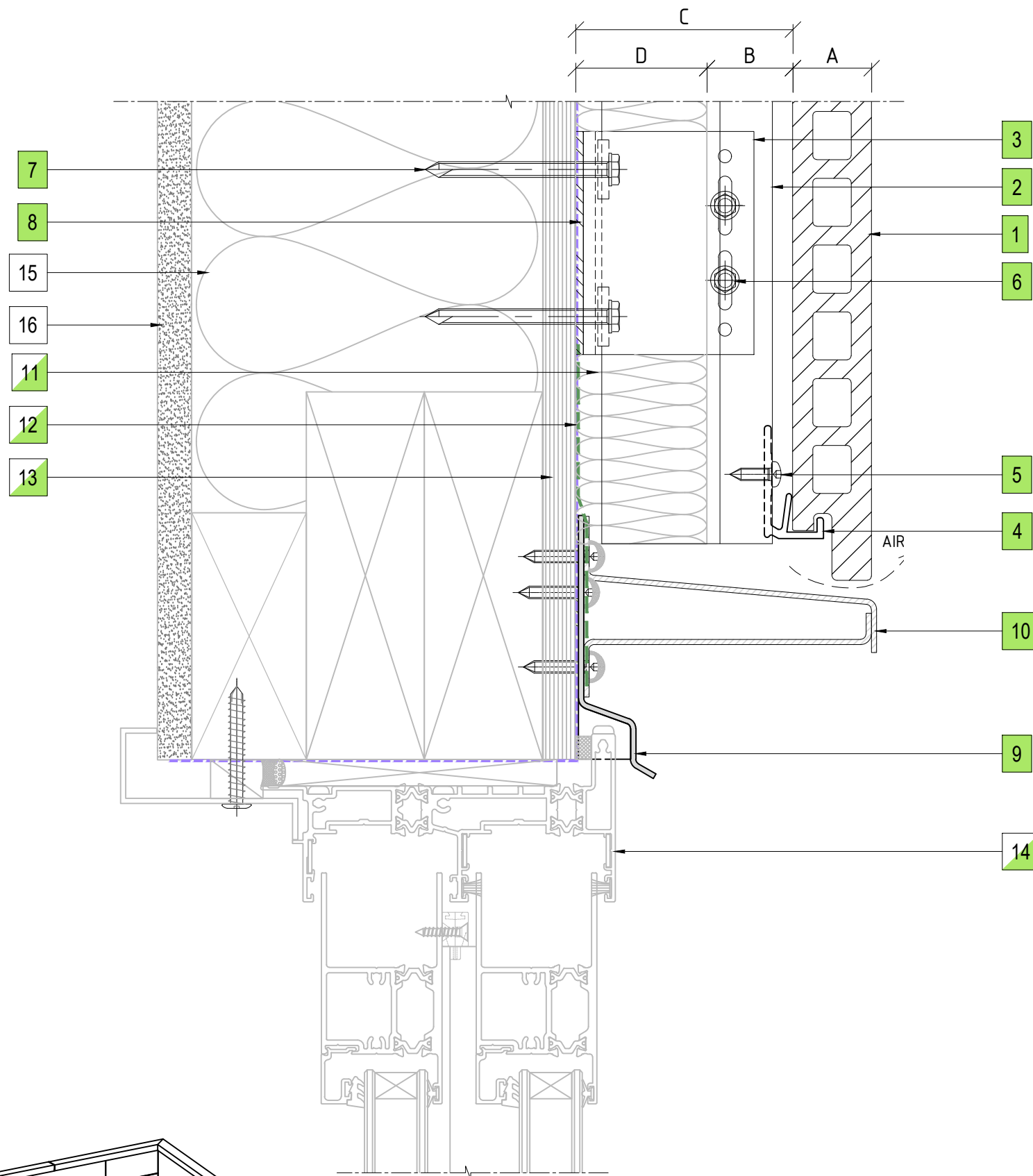

14 DOOR HEAD DETAIL  
ENCLAD™ TERRACOTTA TILES

**LEGEND**

A	ENCLAD™ TERRACOTTA TILES
B	30mm - 32mm NOMINAL VENTILATION ZONE (AIR GAP)
C	* 82mm SYSTEM CAVITY TO ACCOMMODATE 50mm THICK INSULATION
D	* 50mm INSULATION (OPTION BY INSITE) FIRE STOP (OPTION BY INSITE)
*	OTHER OPTIONS AVAILABLE (PROJECT SPECIFIC) 105mm SYSTEM CAVITY FOR 75mm THICK INSULATION

**PARTS LIST**

1	ENCLAD™ TERRACOTTA TILE
2	ENCLAD EN01 ALUMINIUM SUPPORT PROFILE
3	ENCLAD EN01 ALUMINIUM HELPING HAND BRACKET
4	ENCLAD EN01 ALUMINIUM TILE CLIP
5	ENCLAD CLIP FIXING (STAINLESS STEEL)
6	ENCLAD BRACKET TO RAIL FIXING (STAINLESS STEEL)
7	ENCLAD HOST STRUCTURAL FIXING (STAINLESS STEEL)
8	ENCLAD THERMAL ISOLATION PAD
9	ENCLAD ALUMINIUM FLASHING
10	ENCLAD ALUMINIUM CLOSURE
11	CAVITY INSULATION (OPTION BY INSITE)
12	BUILDING WRAP / MEMBRANE (OPTION BY INSITE)
13	RIGID AIR BARRIER / SHEATHING BOARD (OPTION BY INSITE)
14	ALUMINIUM DOORS, WINDOWS & REVEALS (OPTION BY INSITE)
15	WALL INSULATION (BY OTHERS)
16	PLASTER BOARD (BY OTHERS)

Cladding Type :

**ENCLAD™ TERRACOTTA TILES - HORIZONTALLY LAID**

Support System :

**ENCLAD™ EN02 - HOOK ON SECRET FIXED**

Detail Description :

**DOOR HEAD DETAIL (SECTION VIEW)**

Scale @ A3 : 1:2

Rev. : NOV 2022

System # :

**TERRA-H-EN02-HOR-SF3**

Detail # :

**14**

**ENCLAD™ RAINSCREEN SYSTEMS**

**LEGEND**

A	ENCLAD™ TERRACOTTA TILES
B	30mm - 32mm NOMINAL VENTILATION ZONE (AIR GAP)
C	* 82mm SYSTEM CAVITY TO ACCOMMODATE 50mm THICK INSULATION
D	* 50mm INSULATION (OPTION BY INSITE) FIRE STOP (OPTION BY INSITE)
*	OTHER OPTIONS AVAILABLE (PROJECT SPECIFIC) 105mm SYSTEM CAVITY FOR 75mm THICK INSULATION

**PARTS LIST**

1	ENCLAD™ TERRACOTTA TILE
2	ENCLAD EN01 ALUMINIUM SUPPORT PROFILE
3	ENCLAD EN01 ALUMINIUM HELPING HAND BRACKET
4	ENCLAD EN01 ALUMINIUM TILE CLIP
5	ENCLAD CLIP FIXING (STAINLESS STEEL)
6	ENCLAD BRACKET TO RAIL FIXING (STAINLESS STEEL)
7	ENCLAD HOST STRUCTURAL FIXING (STAINLESS STEEL)
8	ENCLAD THERMAL ISOLATION PAD
9	ENCLAD ALUMINIUM FLASHING
10	ENCLAD ALUMINIUM BRACKET
11	CAVITY INSULATION (OPTION BY INSITE)
12	BUILDING WRAP / MEMBRANE (OPTION BY INSITE)
13	RIGID AIR BARRIER / SHEATHING BOARD (OPTION BY INSITE)
14	ALUMINIUM DOORS, WINDOWS & REVEALS (OPTION BY INSITE)
15	WALL INSULATION (BY OTHERS)
16	PLASTER BOARD (BY OTHERS)

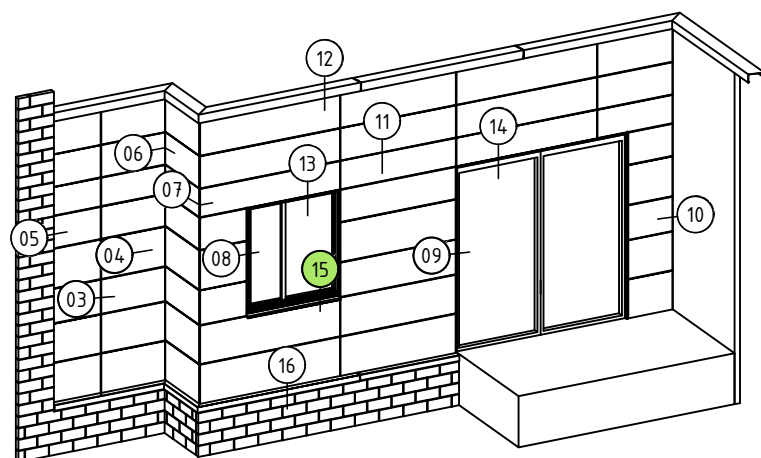
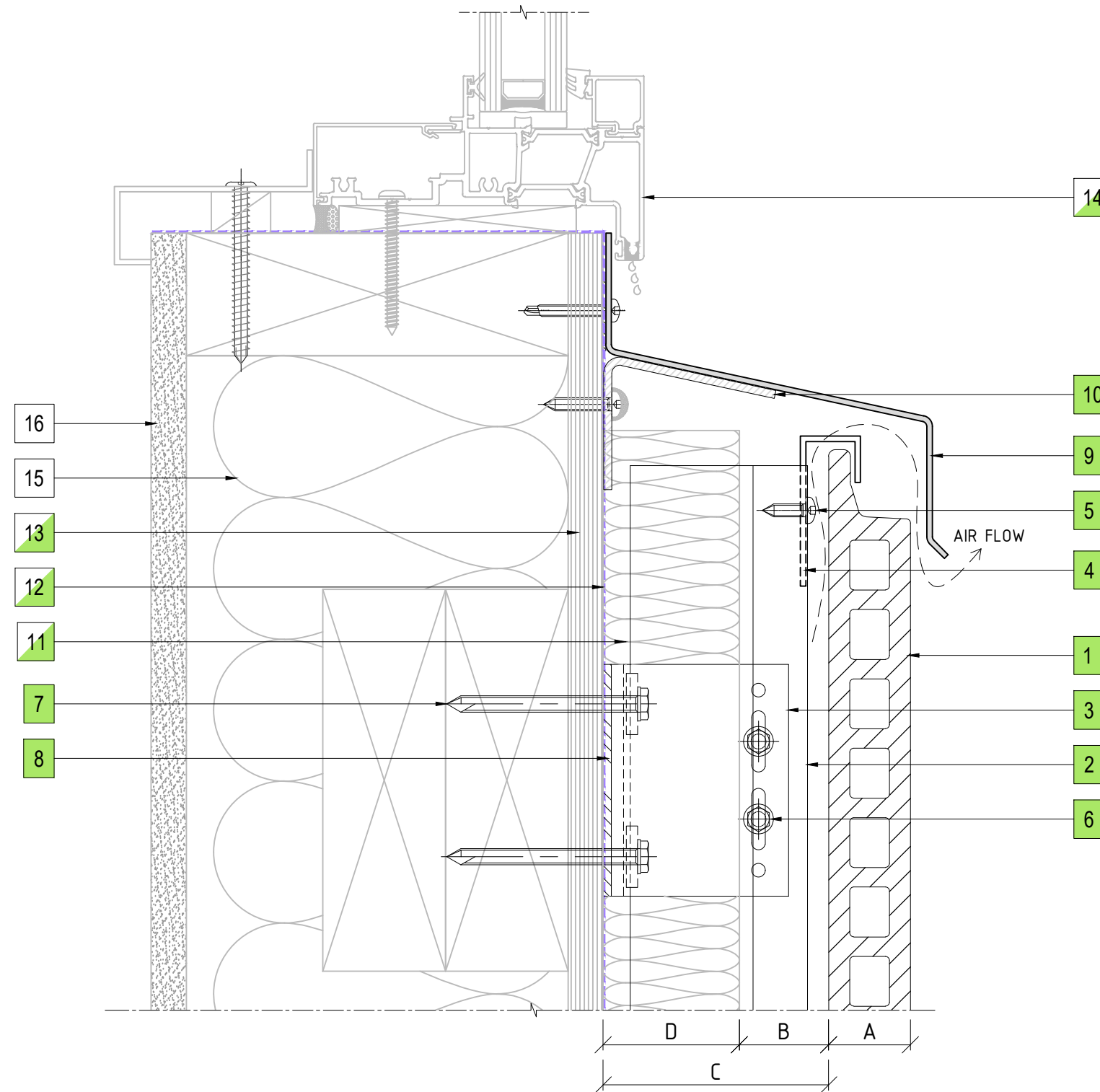

15 WINDOW SILL DETAIL  
ENCLAD™ TERRACOTTA TILES

Cladding Type :

**ENCLAD™ TERRACOTTA TILES - HORIZONTALLY LAID**

Support System :

**ENCLAD™ EN02 - HOOK ON SECRET FIXED**

Detail Description :

WINDOW SILL DETAIL (SECTION VIEW)

Scale @ A3 : 1:2

Rev. : NOV 2022

System # :

TERRA-H-EN02-HOR-SF3

Detail # :

15

**ENCLAD™ RAINSCREEN SYSTEMS**

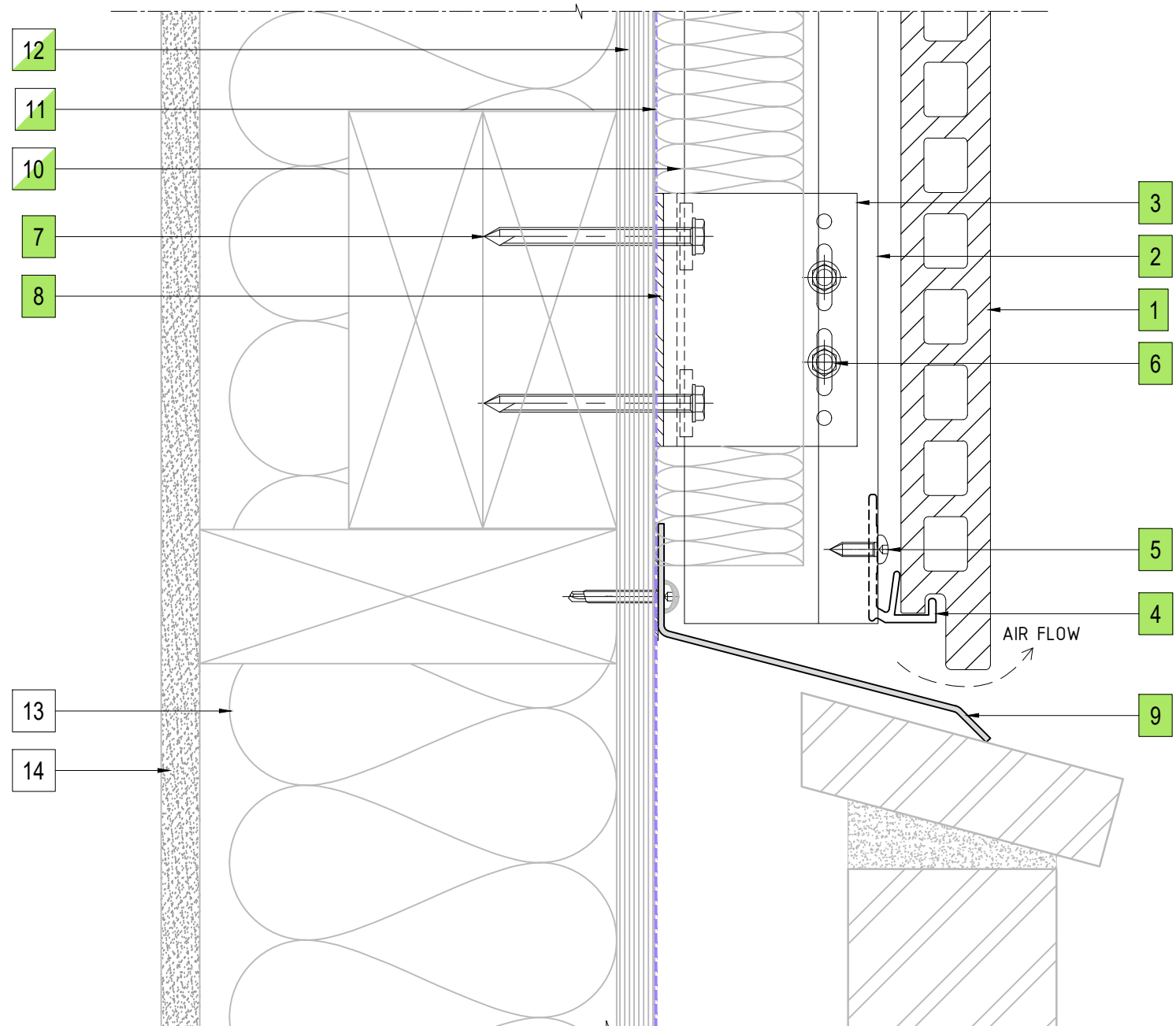

**LEGEND**

A	ENCLAD™ TERRACOTTA TILES
B	30mm - 32mm NOMINAL VENTILATION ZONE (AIR GAP)
C	* 82mm SYSTEM CAVITY TO ACCOMMODATE 50mm THICK INSULATION
D	* 50mm INSULATION (OPTION BY INSITE) FIRE STOP (OPTION BY INSITE)
*	OTHER OPTIONS AVAILABLE (PROJECT SPECIFIC) 105mm SYSTEM CAVITY FOR 75mm THICK INSULATION

**PARTS LIST**

1	ENCLAD™ TERRACOTTA TILE
2	ENCLAD EN01 ALUMINIUM SUPPORT PROFILE
3	ENCLAD EN01 ALUMINIUM HELPING HAND BRACKET
4	ENCLAD EN01 ALUMINIUM TILE CLIP
5	ENCLAD CLIP FIXING (STAINLESS STEEL)
6	ENCLAD BRACKET TO RAIL FIXING (STAINLESS STEEL)
7	ENCLAD HOST STRUCTURAL FIXING (STAINLESS STEEL)
8	ENCLAD THERMAL ISOLATION PAD
9	ENCLAD ALUMINIUM FLASHING
10	CAVITY INSULATION (OPTION BY INSITE)
11	BUILDING WRAP / MEMBRANE (OPTION BY INSITE)
12	RIGID AIR BARRIER / SHEATHING BOARD (OPTION BY INSITE)
13	WALL INSULATION (BY OTHERS)
14	PLASTER BOARD (BY OTHERS)

Cladding Type :

**ENCLAD™ TERRACOTTA TILES - HORIZONTALLY LAID**

Support System :

**ENCLAD™ EN02 - HOOK ON SECRET FIXED**

Detail Description :

**BRICKWALL AT BASE DRIP DETAIL (SECTION VIEW)**

Scale @ A3 : 1:2

Rev. : NOV 2022

System # :

TERRA-H-EN02-HOR-SF3

Detail # :

16

**ENCLAD™ RAINSCREEN SYSTEMS**

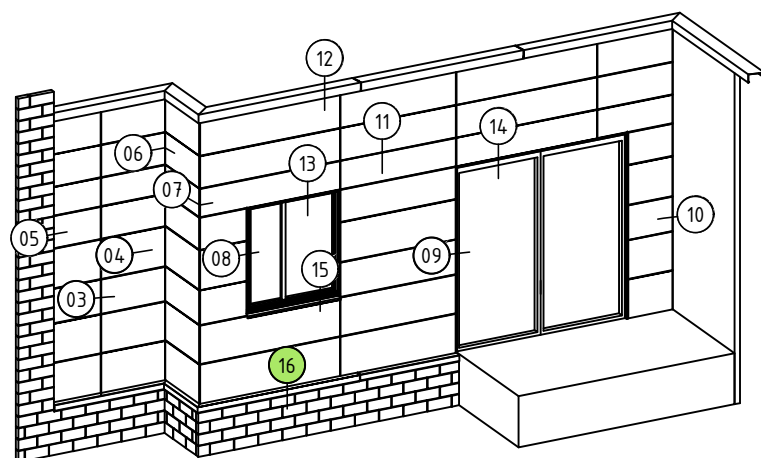

**16** BRICKWALL AT BASE DRIP DETAIL  
ENCLAD™ TERRACOTTA TILES