

# ENCLAD™ PORCELAIN TILES

## ENCLAD™ EN03 SUPPORT SYSTEM

### HOOK ON SECRET FIXED

#### DRAWING REGISTER

PAGE	DETAIL DESCRIPTION	DETAIL #	REV.
00/15	COVER PAGE	00	NOV 22
01/15	CAVITY SET OUT	01	NOV 22
02/15	SCHEMATIC	02	NOV 22
03/15	VERTICAL PANEL JOINT DETAIL (PLAN VIEW)	03	NOV 22
04/15	BRICKWALL ABUTMENT DETAIL (PLAN VIEW)	04	NOV 22
05/15	INTERNAL CORNER PANEL DETAIL (PLAN VIEW)	05	NOV 22
06/15	EXTERNAL CORNER PANEL DETAIL (PLAN VIEW)	06	NOV 22
07/15	WINDOW JAMB DETAIL (PLAN VIEW)	07	NOV 22
08/15	DOOR JAMB DETAIL (PLAN VIEW)	08	NOV 22
09/15	CONCRETE WALL ABUTMENT DETAIL (PLAN VIEW)	09	NOV 22
10/15	HORIZONTAL PANEL JOINT DETAIL (SECTION VIEW)	10	NOV 22
11/15	PARAPET FLASHING DETAIL (SECTION VIEW)	11	NOV 22
12/15	WINDOW HEAD DETAIL (SECTION VIEW)	12	NOV 22
13/15	DOOR HEAD DETAIL (SECTION VIEW)	13	NOV 22
14/15	WINDOW SILL DETAIL (SECTION VIEW)	14	NOV 22
15/15	BRICKWALL AT BASE DRIP DETAIL (SECTION VIEW)	15	NOV 22

PART OF THE THERMOSASH GROUP COMPANIES :





COPYRIGHT : THESE DESIGNS, DETAILS AND/OR SPECIFICATIONS AND THE COPYRIGHT THEREIN, REMAIN THE PROPERTY OF INSITE FACADES LTD.

DISCLAIMER : THESE DETAILS ARE PROVIDED FOR INDICATIVE PURPOSES ONLY. CONSTRUCTION/SYSTEM DETAILS CAN VARY DEPENDING ON PROJECT SPECIFIC SPECIFICATION AND ENGINEERING REQUIREMENTS. THE DESIGNER IS RESPONSIBLE FOR ENSURING DETAILS SATISFY ALL NEW ZEALAND BUILDING CODE CLAUSES. THE DESIGNER IS RESPONSIBLE FOR ENSURING BUILDING WRAPS, FIRESTOPS AND INSULATION/SPECIFICATION COMPLY WITH MANUFACTURERS RECOMMENDATIONS AND NZBC REGULATIONS. REFER TO INSITE WEBSITE FOR FULL TERMS AND CONDITIONS.

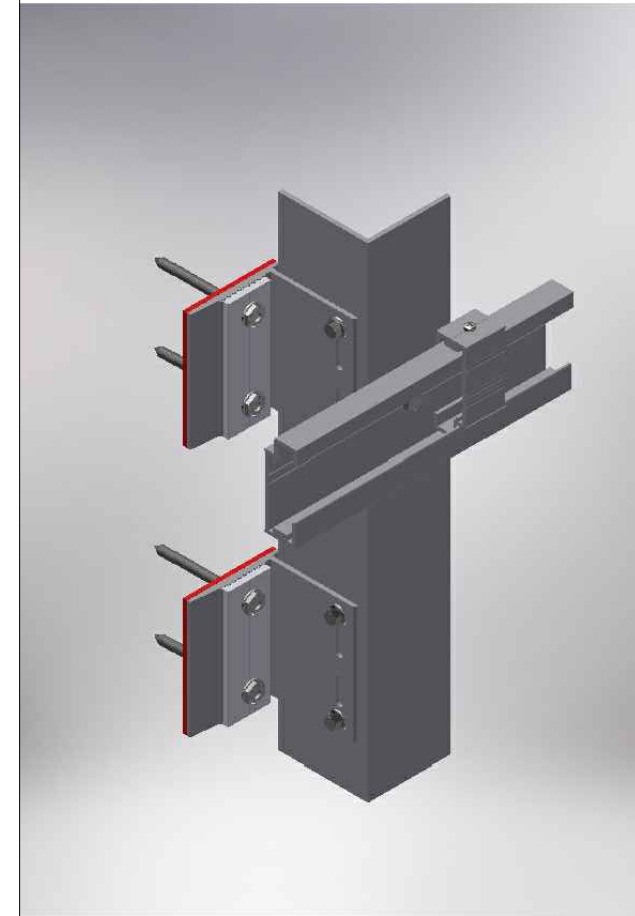

Cladding Type :  
**ENCLAD™ PORCELAIN TILES**

Support System :  
**ENCLAD™ EN03 - HOOK ON SECRET FIXED**

Detail Description :  
COVER PAGE

Scale @ A3 :	Rev. : NOV 2022
System # : PORC-EN03-HOR-SF5	Detail # : 00

EN03 - ADJUSTABLE SYSTEM CAVITY

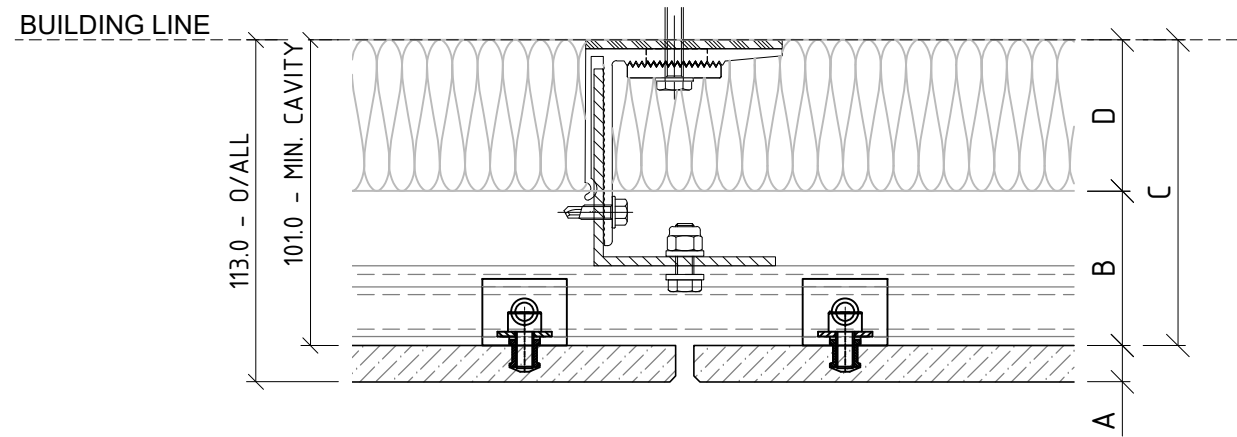

50mm THICK INSULATION  
IN CAVITY ZONE

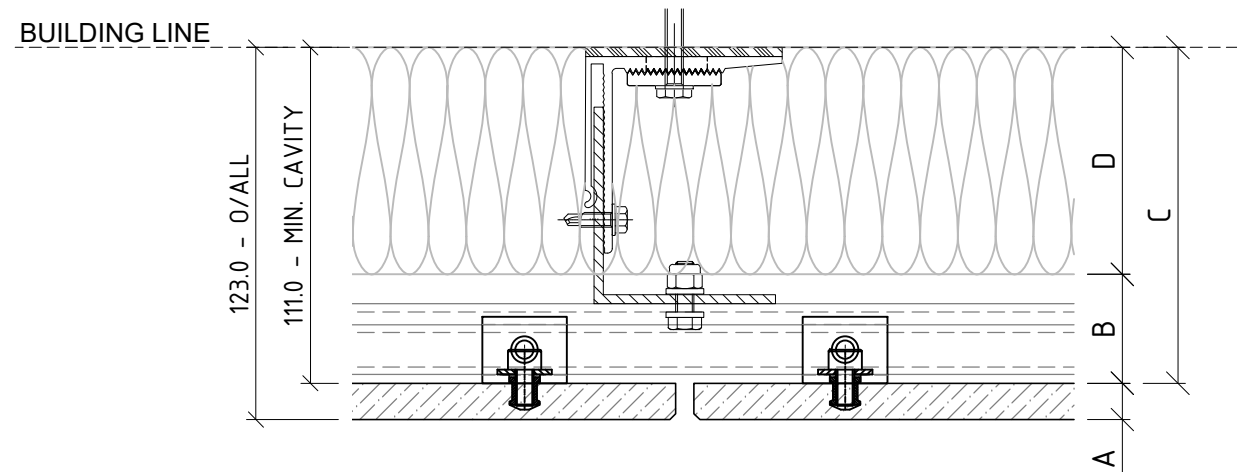

75mm THICK INSULATION  
IN CAVITY ZONE

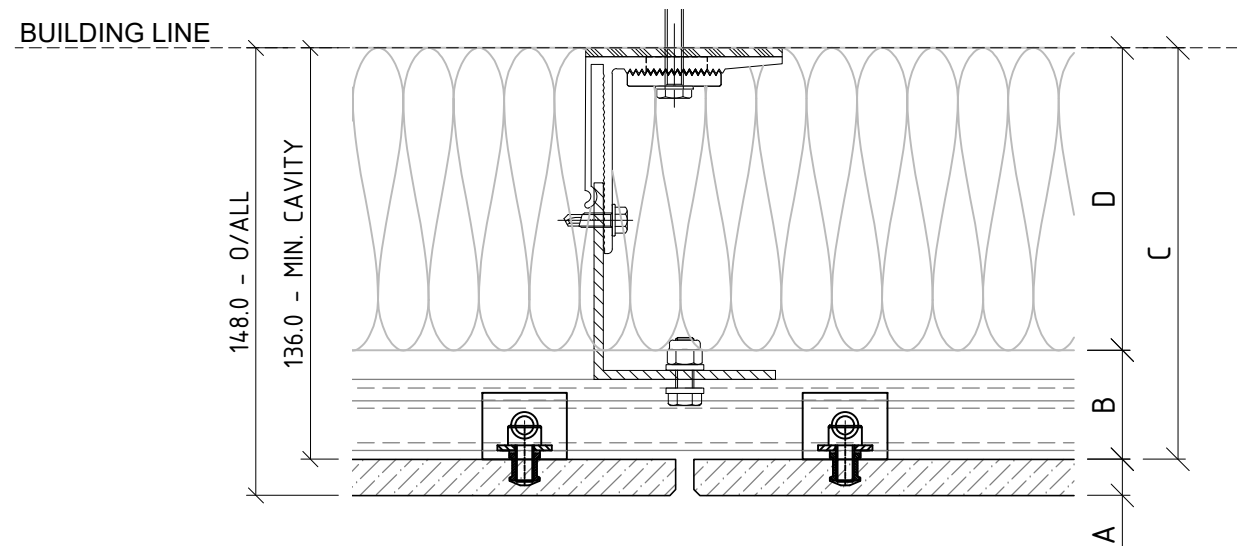

100mm THICK INSULATION  
IN CAVITY ZONE

01 CAVITY SET OUT  
ENCLAD™ PORCELAIN TILES

ADJUSTABLE SYSTEMS ACCOMODATE BUILDING TOLERANCE AND INCORPORATION OF INSULATION FOR H1 REQUIREMENTS - STANDARD SYSTEM CAVITY SHOWN - BESPOKE OPTIONS AVAILABLE FOR PROJECT SPECIFIC REQUIREMENTS

PART OF THE THERMOSASH GROUP COMPANIES :



**COPYRIGHT :** THESE DESIGNS, DETAILS AND/OR SPECIFICATIONS AND THE COPYRIGHT THEREIN, REMAIN THE PROPERTY OF INSITE FACADES LTD.

**DISCLAIMER :** THESE DETAILS ARE PROVIDED FOR INDICATIVE PURPOSES ONLY. CONSTRUCTION/SYSTEM DETAILS CAN VARY DEPENDING ON PROJECT SPECIFIC SPECIFICATION AND ENGINEERING REQUIREMENTS. THE DESIGNER IS RESPONSIBLE FOR ENSURING DETAILS SATISFY ALL NEW ZEALAND BUILDING CODE CLAUSES. THE DESIGNER IS RESPONSIBLE FOR ENSURING BUILDING WRAPS, FIRESTOPS AND INSULATION/SPECIFICATION COMPLY WITH MANUFACTURERS RECOMMENDATIONS AND NZBC REGULATIONS. REFER TO INSITE WEBSITE FOR FULL TERMS AND CONDITIONS.

**LEGEND**

A	ENCLAD™ PORCELAIN TILES
B	36mm - 51mm NOMINAL VENTILATION ZONE (AIR GAP)
C	* 101mm SYSTEM CAVITY TO ACCOMMODATE 50mm THICK INSULATION
D	* 50mm INSULATION (OPTION BY INSITE) FIRE STOP (OPTION BY INSITE)
*	OTHER OPTIONS AVAILABLE (PROJECT SPECIFIC) 111mm SYSTEM CAVITY FOR 75mm THICK INSULATION 136mm SYSTEM CAVITY FOR 100mm THICK INSULATION

Cladding Type :  
**ENCLAD™ PORCELAIN TILES**

Support System :  
**ENCLAD™ EN03 - HOOK ON SECRET FIXED**

Detail Description :  
CAVITY SETOUT (PLAN VIEW)

Scale @ A3 : 1:2.5

Rev. : NOV 2022

System # :  
PORC-EN03-HOR-SF5

Detail # :  
01

**ENCLAD™ RAINSCREEN SYSTEMS**



101 STATION ROAD, PENROSE,  
AUCKLAND 1061  
NEW ZEALAND

P: +64 9 307 1529  
www.insitefacades.co.nz

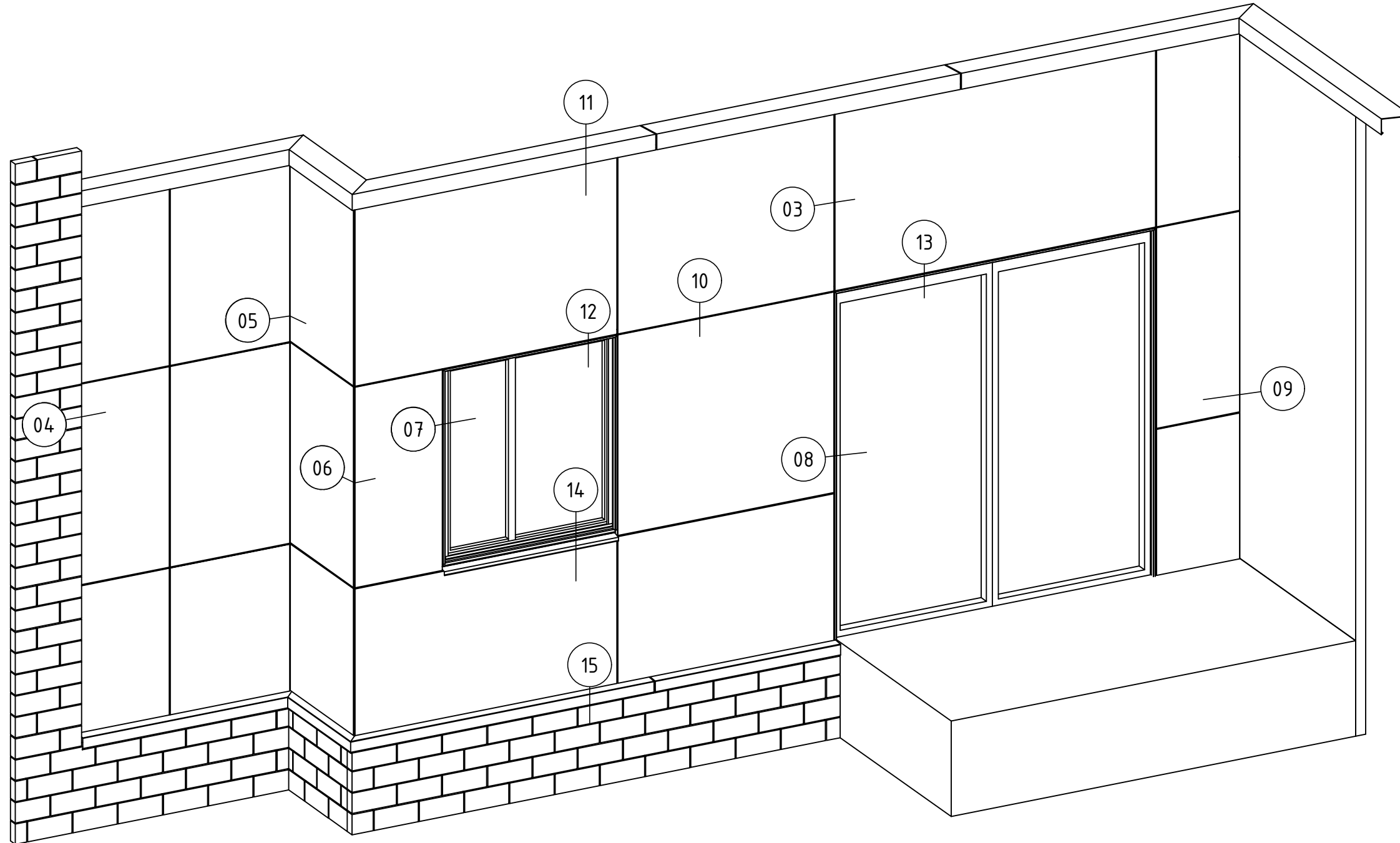

02 SCHEMATIC  
ENCLAD™ PORCELAIN TILES

Cladding Type :  
**ENCLAD™ PORCELAIN TILES**

Support System :  
**ENCLAD™ EN03 - HOOK ON SECRET FIXED**

Detail Description :  
SCHEMATIC

Scale @ A3 : 1:5

Rev. : NOV 2022

System # :  
PORC-EN03-HOR-SF5

Detail # :  
02

**ENCLAD™ RAINSCREEN SYSTEMS**

**LEGEND**

A	ENCLAD™ PORCELAIN TILES
B	36mm - 51mm NOMINAL VENTILATION ZONE (AIR GAP)
C	* 101mm SYSTEM CAVITY TO ACCOMMODATE 50mm THICK INSULATION
D	* 50mm INSULATION (OPTION BY INSITE) FIRE STOP (OPTION BY INSITE)
*	OTHER OPTIONS AVAILABLE (PROJECT SPECIFIC) 111mm SYSTEM CAVITY FOR 75mm THICK INSULATION 136mm SYSTEM CAVITY FOR 100mm THICK INSULATION

**PARTS LIST**

1	ENCLAD™ PORCELAIN TILE
2	ENCLAD EN01 ALUMINIUM SUPPORT PROFILE
3	ENCLAD EN01 ALUMINIUM HELPING HAND BRACKET
4	ENCLAD EN01 ALUMINIUM HORIZONTAL RAIL
5	ENCLAD EN01 ALUMINIUM TILE CLIP
6	ENCLAD TILE FIXING (STAINLESS STEEL)
7	ENCLAD BRACKET TO RAIL FIXING (STAINLESS STEEL)
8	ENCLAD RAIL TO RAIL FIXING (STAINLESS STEEL)
9	ENCLAD HOST STRUCTURAL FIXING (STAINLESS STEEL)
10	ENCLAD THERMAL ISOLATION PAD
11	CAVITY INSULATION (OPTION BY INSITE)
12	BUILDING WRAP / MEMBRANE (OPTION BY INSITE)
13	RIGID AIR BARRIER / SHEATHING BOARD (OPTION BY INSITE)
14	WALL INSULATION (BY OTHERS)
15	PLASTER BOARD (BY OTHERS)

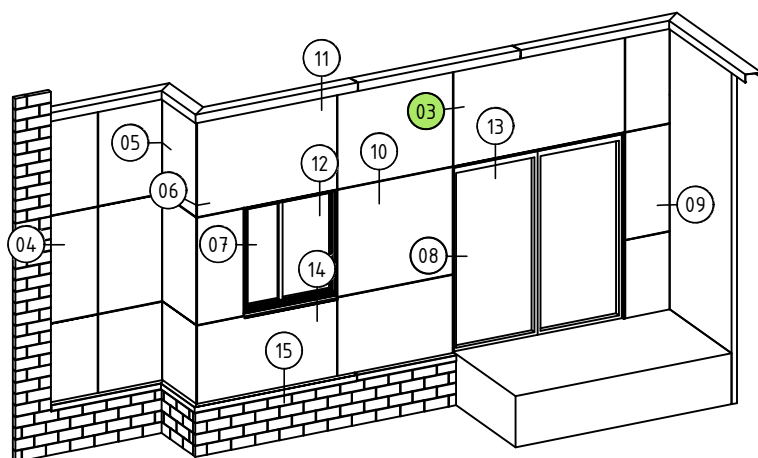
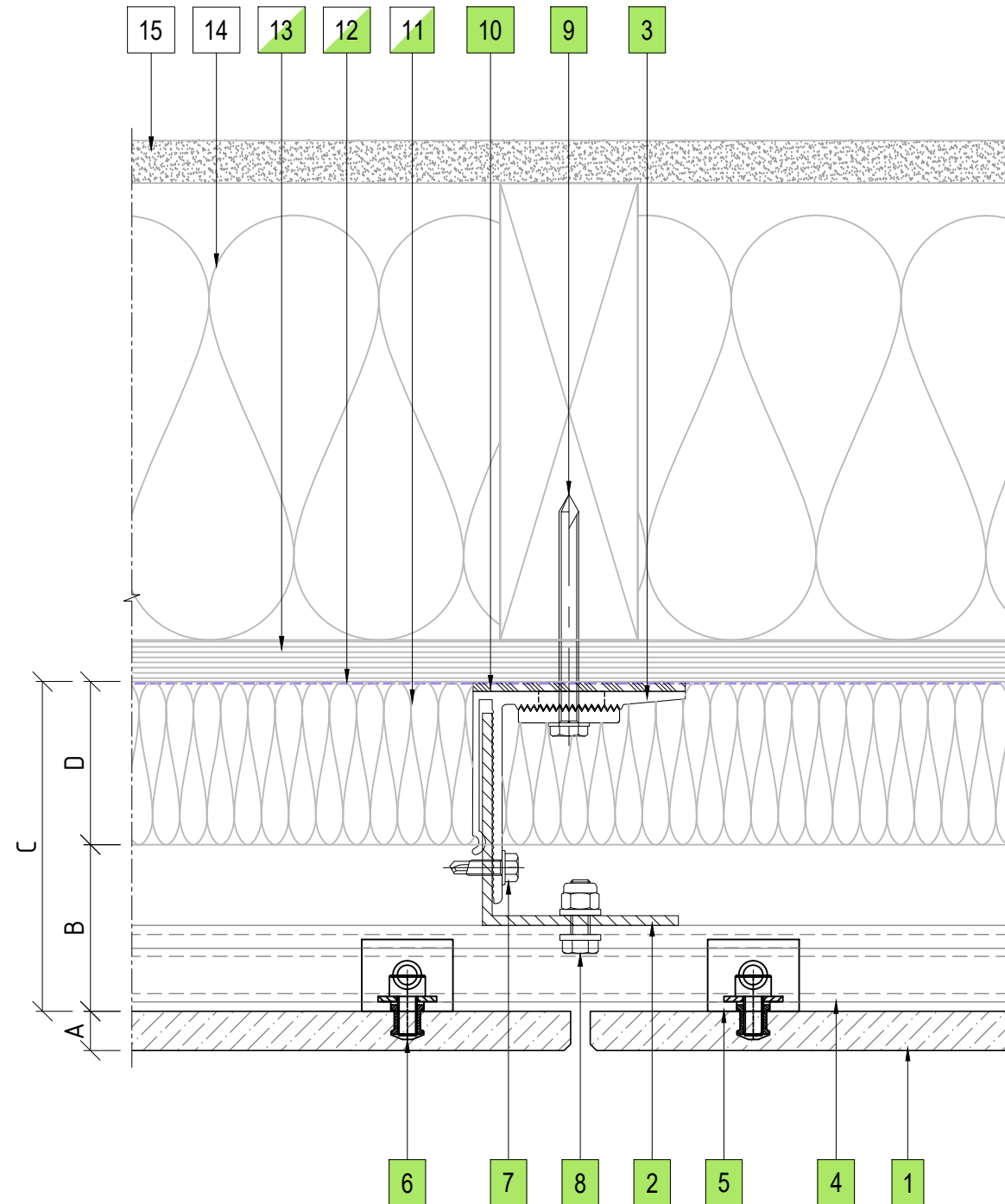

03 VERTICAL PANEL JOINT DETAIL  
ENCLAD™ PORCELAIN TILES

Cladding Type :

**ENCLAD™ PORCELAIN TILES**

Support System :

**ENCLAD™ EN03 - HOOK ON SECRET FIXED**

Detail Description :

VERTICAL PANEL JOINT DETAIL (PLAN VIEW)

Scale @ A3 : 1:2

Rev. : NOV 2022

System # :

PORC-EN03-HOR-SF5

Detail # :

03

**ENCLAD™ RAINSCREEN SYSTEMS**

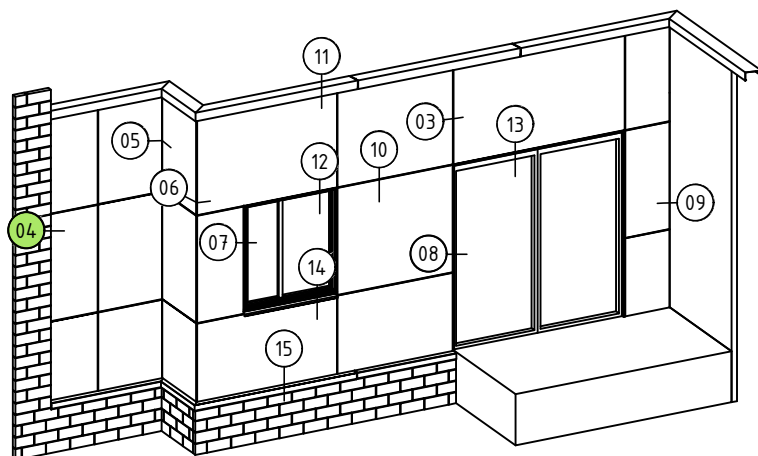
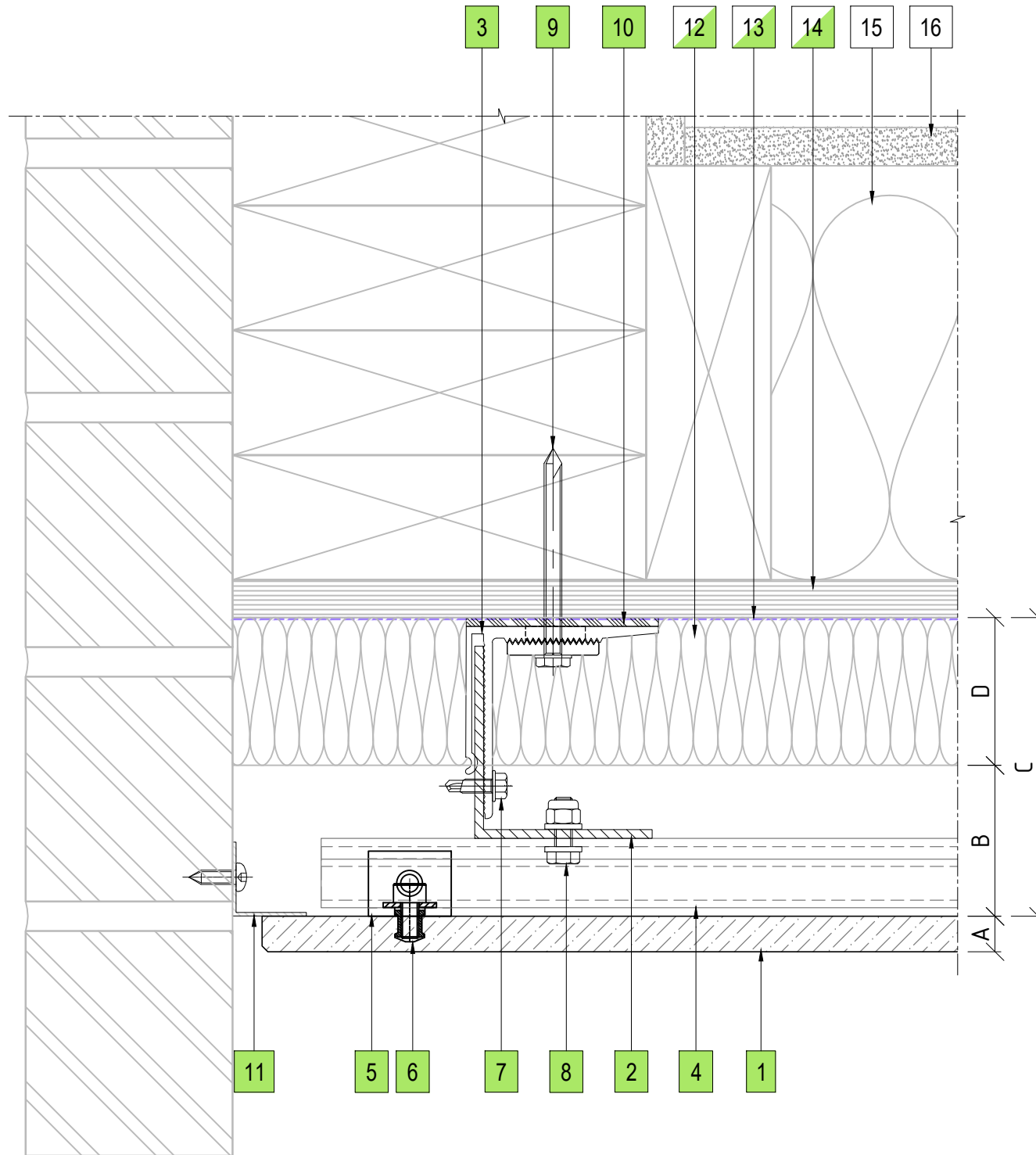

04 BRICKWALL ABUTMENT DETAIL  
ENCLAD™ PORCELAIN TILES

**LEGEND**

A	ENCLAD™ PORCELAIN TILES
B	36mm - 51mm NOMINAL VENTILATION ZONE (AIR GAP)
C	* 101mm SYSTEM CAVITY TO ACCOMMODATE 50mm THICK INSULATION
D	* 50mm INSULATION (OPTION BY INSITE) FIRE STOP (OPTION BY INSITE)
*	OTHER OPTIONS AVAILABLE (PROJECT SPECIFIC) 111mm SYSTEM CAVITY FOR 75mm THICK INSULATION 136mm SYSTEM CAVITY FOR 100mm THICK INSULATION

**PARTS LIST**

1	ENCLAD™ PORCELAIN TILE
2	ENCLAD EN01 ALUMINIUM SUPPORT PROFILE
3	ENCLAD EN01 ALUMINIUM HELPING HAND BRACKET
4	ENCLAD EN01 ALUMINIUM HORIZONTAL RAIL
5	ENCLAD EN01 ALUMINIUM TILE CLIP
6	ENCLAD TILE FIXING (STAINLESS STEEL)
7	ENCLAD BRACKET TO RAIL FIXING (STAINLESS STEEL)
8	ENCLAD RAIL TO RAIL FIXING (STAINLESS STEEL)
9	ENCLAD HOST STRUCTURAL FIXING (STAINLESS STEEL)
10	ENCLAD THERMAL ISOLATION PAD
11	ENCLAD ALUMINIUM CLOSURE
12	CAVITY INSULATION (OPTION BY INSITE)
13	BUILDING WRAP / MEMBRANE (OPTION BY INSITE)
14	RIGID AIR BARRIER / SHEATHING BOARD (OPTION BY INSITE)
15	WALL INSULATION (BY OTHERS)
16	PLASTER BOARD (BY OTHERS)

Cladding Type :

**ENCLAD™ PORCELAIN TILES**

Support System :

**ENCLAD™ EN03 - HOOK ON SECRET FIXED**

Detail Description :

**BRICKWALL ABUTMENT DETAIL (PLAN VIEW)**

Scale @ A3 : 1:2

Rev. : NOV 2022

System # :

**PORC-EN03-HOR-SF5**

Detail # :

**04**

**ENCLAD™ RAINSCREEN SYSTEMS**

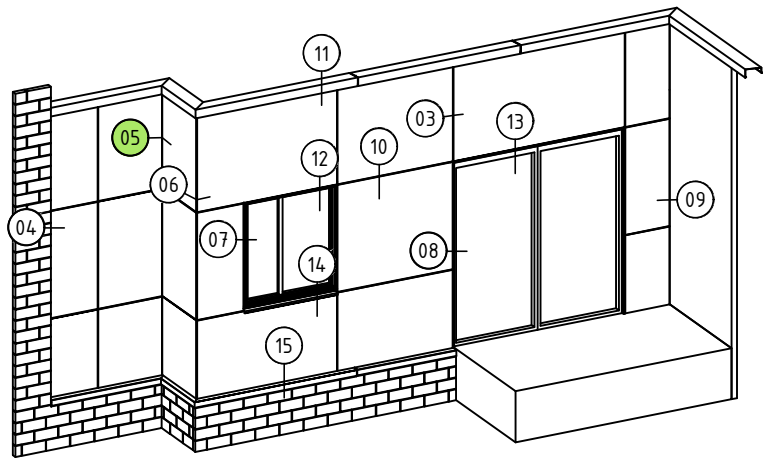
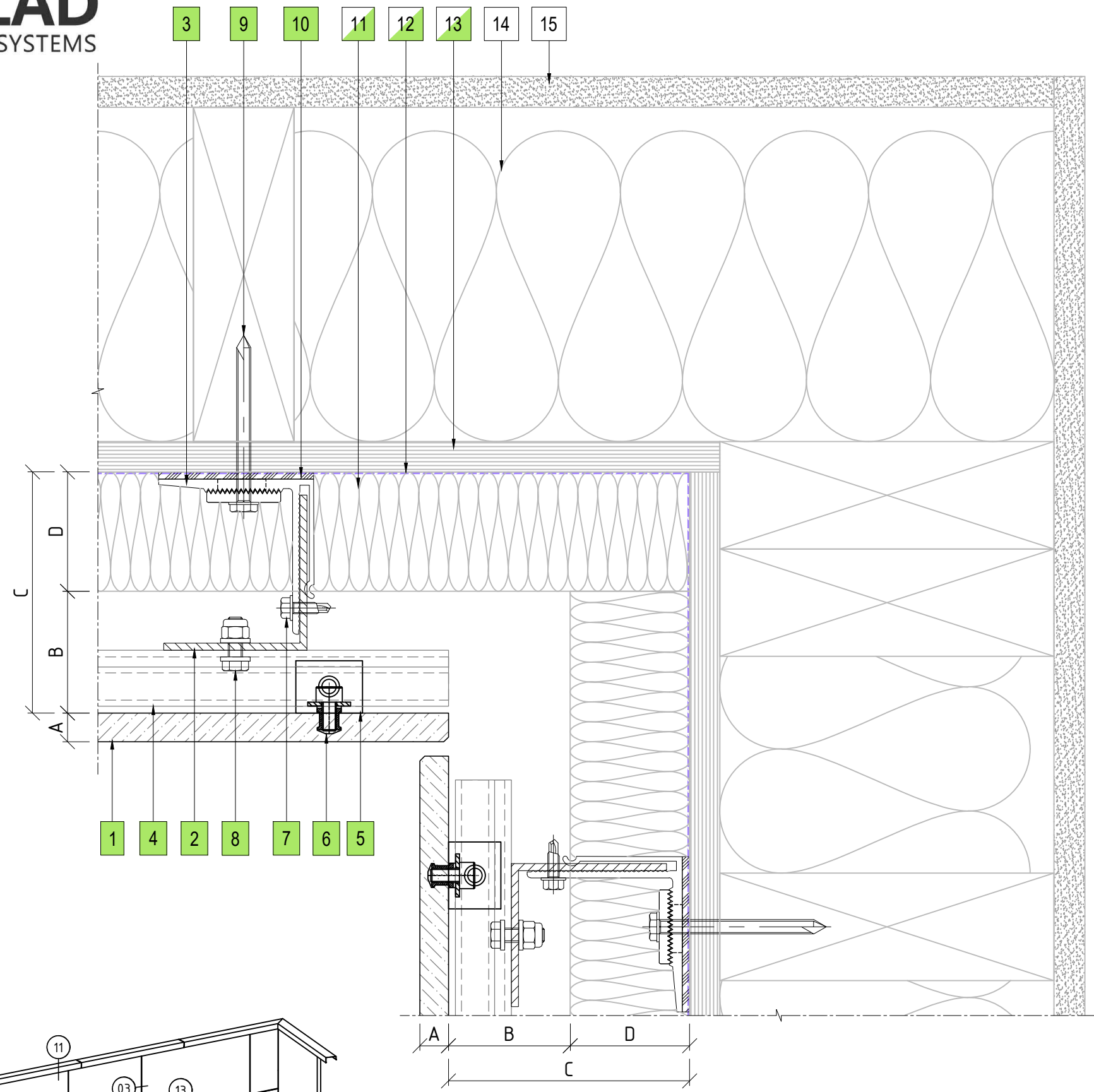

05 INTERNAL CORNER PANEL DETAIL  
ENCLAD™ PORCELAIN TILES

LEGEND	
A	ENCLAD™ PORCELAIN TILES
B	36mm - 51mm NOMINAL VENTILATION ZONE (AIR GAP)
C	* 101mm SYSTEM CAVITY TO ACCOMMODATE 50mm THICK INSULATION
D	* 50mm INSULATION (OPTION BY INSITE) FIRE STOP (OPTION BY INSITE)
*	OTHER OPTIONS AVAILABLE (PROJECT SPECIFIC) 111mm SYSTEM CAVITY FOR 75mm THICK INSULATION 136mm SYSTEM CAVITY FOR 100mm THICK INSULATION

PARTS LIST	
1	ENCLAD™ PORCELAIN TILE
2	ENCLAD EN01 ALUMINIUM SUPPORT PROFILE
3	ENCLAD EN01 ALUMINIUM HELPING HAND BRACKET
4	ENCLAD EN01 ALUMINIUM HORIZONTAL RAIL
5	ENCLAD EN01 ALUMINIUM TILE CLIP
6	ENCLAD TILE FIXING (STAINLESS STEEL)
7	ENCLAD BRACKET TO RAIL FIXING (STAINLESS STEEL)
8	ENCLAD RAIL TO RAIL FIXING (STAINLESS STEEL)
9	ENCLAD HOST STRUCTURAL FIXING (STAINLESS STEEL)
10	ENCLAD THERMAL ISOLATION PAD
11	CAVITY INSULATION (OPTION BY INSITE)
12	BUILDING WRAP / MEMBRANE (OPTION BY INSITE)
13	RIGID AIR BARRIER / SHEATHING BOARD (OPTION BY INSITE)
14	WALL INSULATION (BY OTHERS)
15	PLASTER BOARD (BY OTHERS)

Cladding Type :  
**ENCLAD™ PORCELAIN TILES**

Support System :  
**ENCLAD™ EN03 - HOOK ON SECRET FIXED**

Detail Description :  
INTERNAL CORNER PANEL DETAIL (PLAN VIEW)

Scale @ A3 : 1:2      Rev. : NOV 2022

System # :      Detail # :  
PORC-EN03-HOR-SF5      05

**ENCLAD™ RAINSCREEN SYSTEMS**

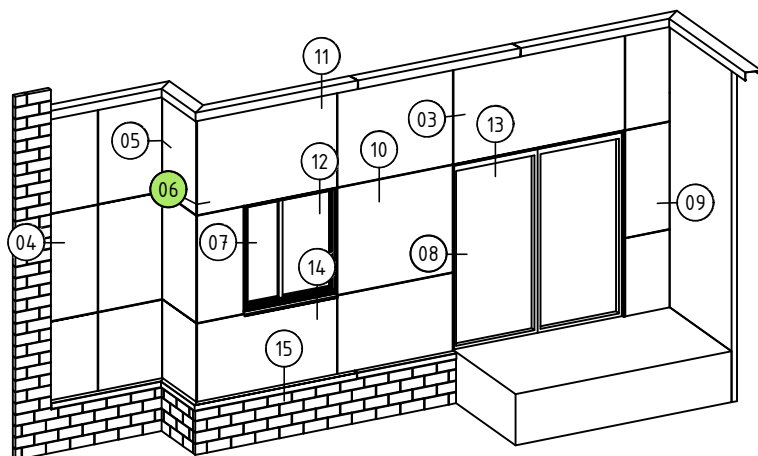
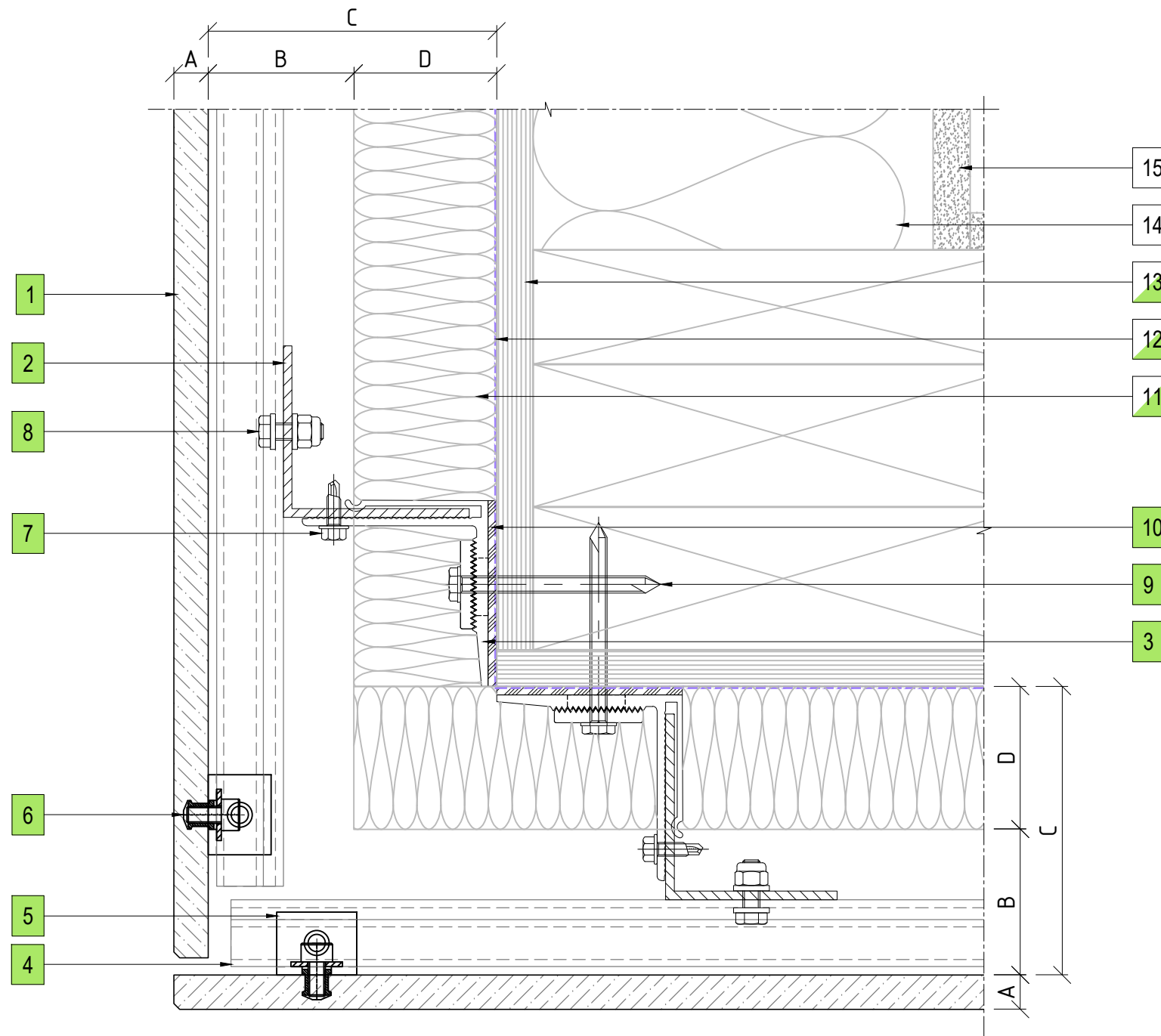

06 EXTERNAL CORNER PANEL DETAIL  
ENCLAD™ PORCELAIN TILES

**LEGEND**

A	ENCLAD™ PORCELAIN TILES
B	36mm - 51mm NOMINAL VENTILATION ZONE (AIR GAP)
C	* 101mm SYSTEM CAVITY TO ACCOMMODATE 50mm THICK INSULATION
D	* 50mm INSULATION (OPTION BY INSITE) FIRE STOP (OPTION BY INSITE)
*	OTHER OPTIONS AVAILABLE (PROJECT SPECIFIC) 111mm SYSTEM CAVITY FOR 75mm THICK INSULATION 136mm SYSTEM CAVITY FOR 100mm THICK INSULATION

**PARTS LIST**

1	ENCLAD™ PORCELAIN TILE
2	ENCLAD EN01 ALUMINIUM SUPPORT PROFILE
3	ENCLAD EN01 ALUMINIUM HELPING HAND BRACKET
4	ENCLAD EN01 ALUMINIUM HORIZONTAL RAIL
5	ENCLAD EN01 ALUMINIUM TILE CLIP
6	ENCLAD TILE FIXING (STAINLESS STEEL)
7	ENCLAD BRACKET TO RAIL FIXING (STAINLESS STEEL)
8	ENCLAD RAIL TO RAIL FIXING (STAINLESS STEEL)
9	ENCLAD HOST STRUCTURAL FIXING (STAINLESS STEEL)
10	ENCLAD THERMAL ISOLATION PAD
11	CAVITY INSULATION (OPTION BY INSITE)
12	BUILDING WRAP / MEMBRANE (OPTION BY INSITE)
13	RIGID AIR BARRIER / SHEATHING BOARD (OPTION BY INSITE)
14	WALL INSULATION (BY OTHERS)
15	PLASTER BOARD (BY OTHERS)

Cladding Type :

**ENCLAD™ PORCELAIN TILES**

Support System :

**ENCLAD™ EN03 - HOOK ON SECRET FIXED**

Detail Description :

EXTERNAL CORNER PANEL DETAIL (PLAN VIEW)

Scale @ A3 : 1:2

Rev. : NOV 2022

System # :

PORC-EN03-HOR-SF5

Detail # :

06

**ENCLAD™ RAINSCREEN SYSTEMS**

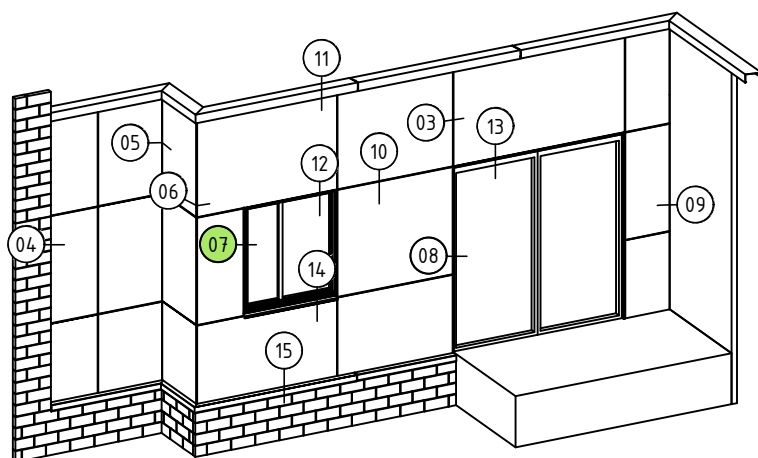
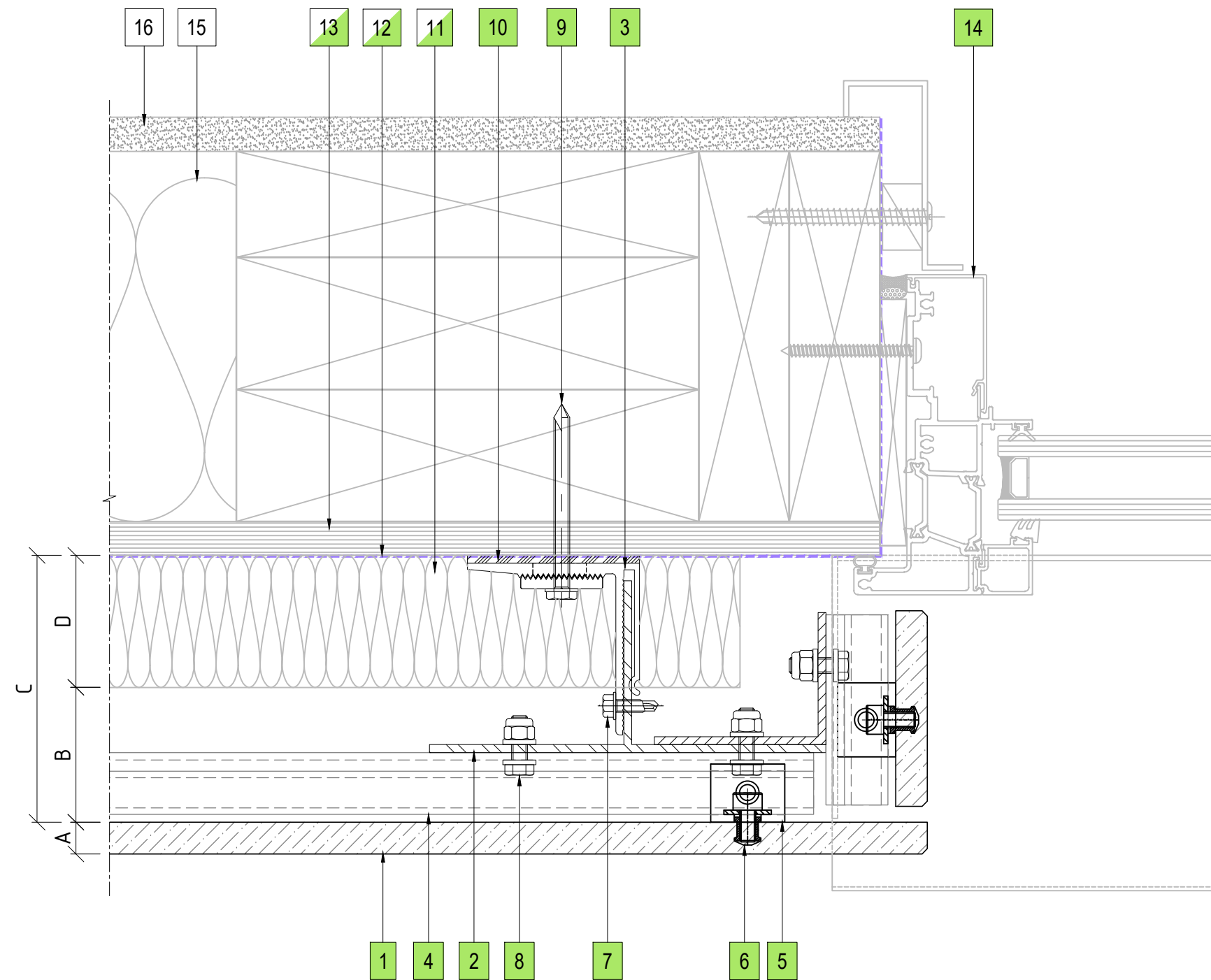

07 WINDOW JAMB DETAIL  
ENCLAD™ PORCELAIN TILES

**LEGEND**

A	ENCLAD™ PORCELAIN TILES
B	36mm - 51mm NOMINAL VENTILATION ZONE (AIR GAP)
C	* 101mm SYSTEM CAVITY TO ACCOMMODATE 50mm THICK INSULATION
D	* 50mm INSULATION (OPTION BY INSITE) FIRE STOP (OPTION BY INSITE)
*	OTHER OPTIONS AVAILABLE (PROJECT SPECIFIC) 111mm SYSTEM CAVITY FOR 75mm THICK INSULATION 136mm SYSTEM CAVITY FOR 100mm THICK INSULATION

**PARTS LIST**

1	ENCLAD™ PORCELAIN TILE
2	ENCLAD EN01 ALUMINIUM SUPPORT PROFILE
3	ENCLAD EN01 ALUMINIUM HELPING HAND BRACKET
4	ENCLAD EN01 ALUMINIUM HORIZONTAL RAIL
5	ENCLAD EN01 ALUMINIUM TILE CLIP
6	ENCLAD TILE FIXING (STAINLESS STEEL)
7	ENCLAD BRACKET TO RAIL FIXING (STAINLESS STEEL)
8	ENCLAD RAIL TO RAIL FIXING (STAINLESS STEEL)
9	ENCLAD HOST STRUCTURAL FIXING (STAINLESS STEEL)
10	ENCLAD THERMAL ISOLATION PAD
11	CAVITY INSULATION (OPTION BY INSITE)
12	BUILDING WRAP / MEMBRANE (OPTION BY INSITE)
13	RIGID AIR BARRIER / SHEATHING BOARD (OPTION BY INSITE)
14	ALUMINIUM DOORS, WINDOWS & REVEALS (OPTION BY INSITE)
15	WALL INSULATION (BY OTHERS)
16	PLASTER BOARD (BY OTHERS)

Cladding Type :

**ENCLAD™ PORCELAIN TILES**

Support System :

**ENCLAD™ EN03 - HOOK ON SECRET FIXED**

Detail Description :

WINDOW JAMB DETAIL (PLAN VIEW)

Scale @ A3 : 1:2

Rev. : NOV 2022

System # :

PORC-EN03-HOR-SF5

Detail # :

07

**ENCLAD™ RAINSCREEN SYSTEMS**



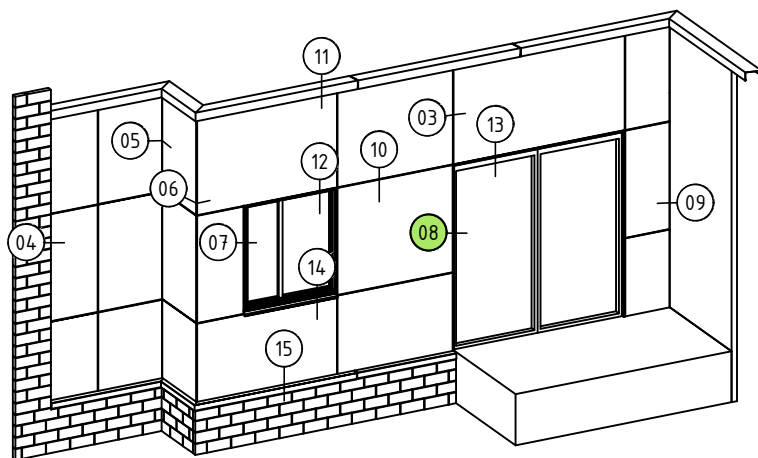
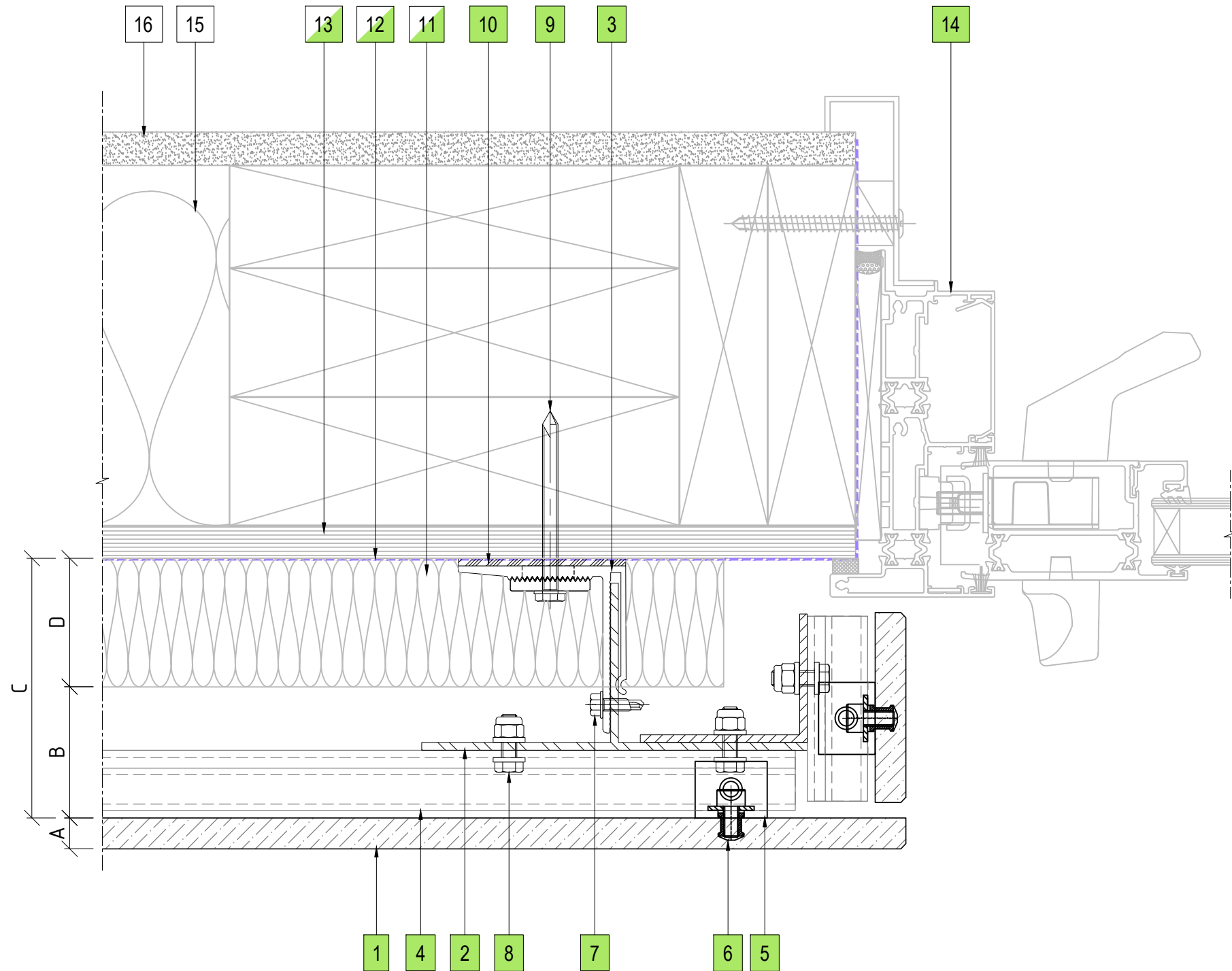

08 DOOR JAMB DETAIL  
ENCLAD™ PORCELAIN TILES

**LEGEND**

A	ENCLAD™ PORCELAIN TILES
B	36mm - 51mm NOMINAL VENTILATION ZONE (AIR GAP)
C	* 101mm SYSTEM CAVITY TO ACCOMMODATE 50mm THICK INSULATION
D	* 50mm INSULATION (OPTION BY INSITE) FIRE STOP (OPTION BY INSITE)
*	OTHER OPTIONS AVAILABLE (PROJECT SPECIFIC) 111mm SYSTEM CAVITY FOR 75mm THICK INSULATION 136mm SYSTEM CAVITY FOR 100mm THICK INSULATION

**PARTS LIST**

1	ENCLAD™ PORCELAIN TILE
2	ENCLAD EN01 ALUMINIUM SUPPORT PROFILE
3	ENCLAD EN01 ALUMINIUM HELPING HAND BRACKET
4	ENCLAD EN01 ALUMINIUM HORIZONTAL RAIL
5	ENCLAD EN01 ALUMINIUM TILE CLIP
6	ENCLAD TILE FIXING (STAINLESS STEEL)
7	ENCLAD BRACKET TO RAIL FIXING (STAINLESS STEEL)
8	ENCLAD RAIL TO RAIL FIXING (STAINLESS STEEL)
9	ENCLAD HOST STRUCTURAL FIXING (STAINLESS STEEL)
10	ENCLAD THERMAL ISOLATION PAD
11	CAVITY INSULATION (OPTION BY INSITE)
12	BUILDING WRAP / MEMBRANE (OPTION BY INSITE)
13	RIGID AIR BARRIER / SHEATHING BOARD (OPTION BY INSITE)
14	ALUMINIUM DOORS, WINDOWS & REVEALS (OPTION BY INSITE)
15	WALL INSULATION (BY OTHERS)
16	PLASTER BOARD (BY OTHERS)

Cladding Type :

**ENCLAD™ PORCELAIN TILES**

Support System :

**ENCLAD™ EN03 - HOOK ON SECRET FIXED**

Detail Description :

**DOOR JAMB DETAIL (PLAN VIEW)**

Scale @ A3 : 1:2

Rev. : NOV 2022

System # :

**PORC-EN03-HOR-SF5**

Detail # :

**08**

**ENCLAD™ RAINSCREEN SYSTEMS**

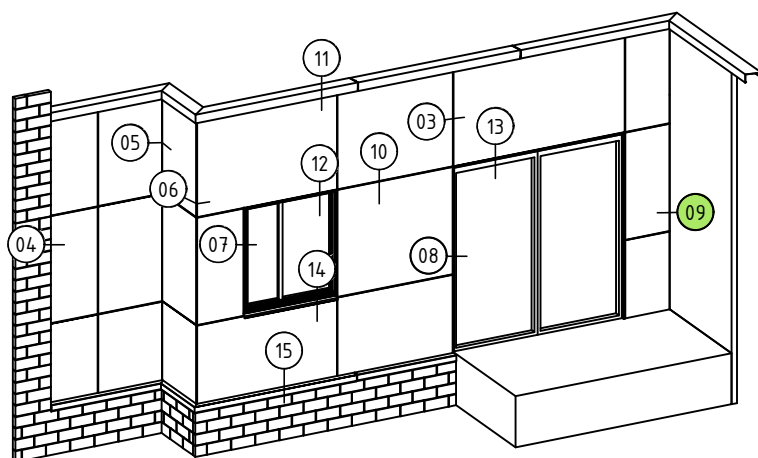
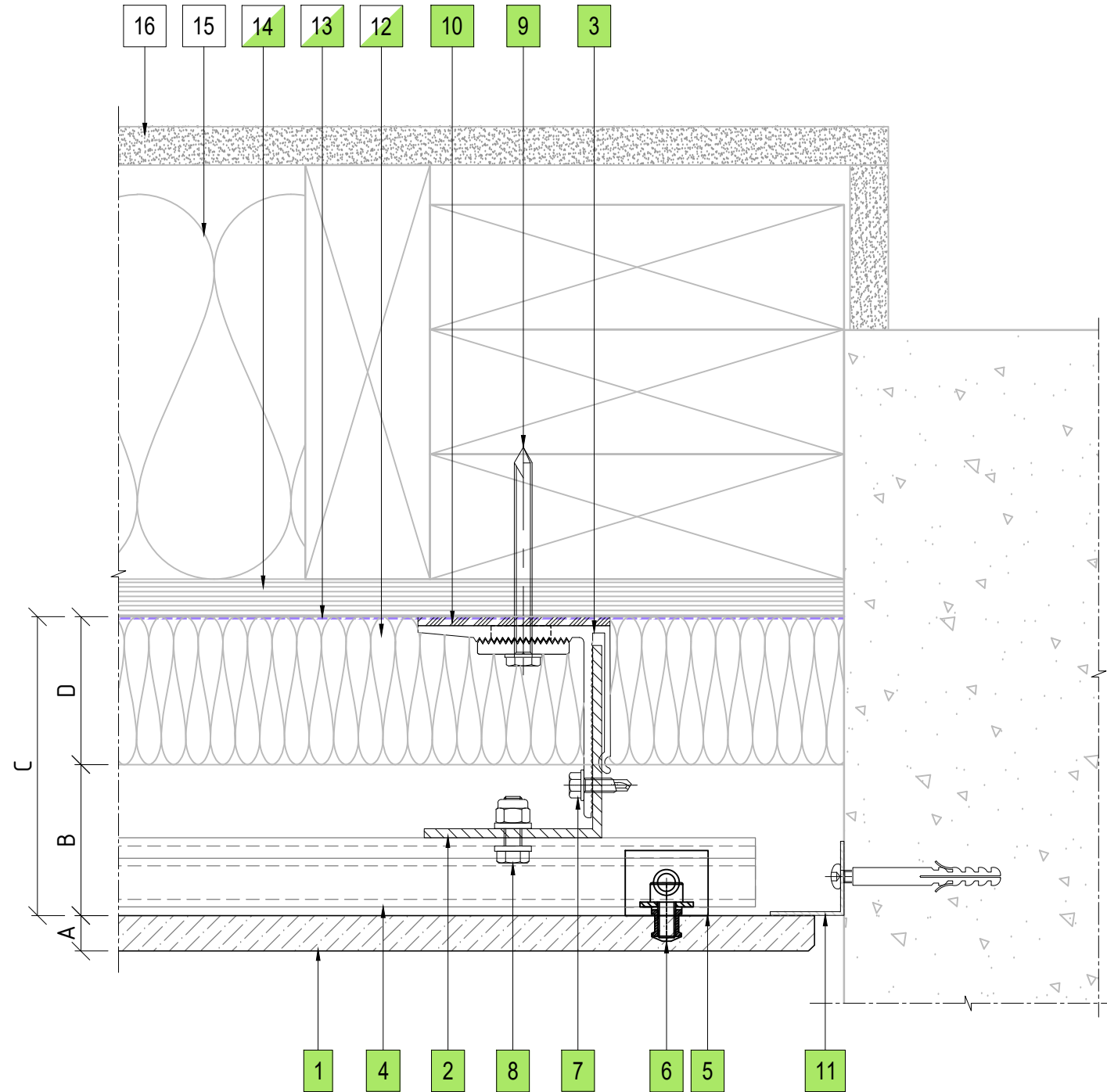

09 CONCRETE WALL ABUTMENT DETAIL  
ENCLAD™ PORCELAIN TILES

**LEGEND**

A	ENCLAD™ PORCELAIN TILES
B	36mm - 51mm NOMINAL VENTILATION ZONE (AIR GAP)
C	* 101mm SYSTEM CAVITY TO ACCOMMODATE 50mm THICK INSULATION
D	* 50mm INSULATION (OPTION BY INSITE) FIRE STOP (OPTION BY INSITE)
*	OTHER OPTIONS AVAILABLE (PROJECT SPECIFIC) 111mm SYSTEM CAVITY FOR 75mm THICK INSULATION 136mm SYSTEM CAVITY FOR 100mm THICK INSULATION

**PARTS LIST**

1	ENCLAD™ PORCELAIN TILE
2	ENCLAD EN01 ALUMINIUM SUPPORT PROFILE
3	ENCLAD EN01 ALUMINIUM HELPING HAND BRACKET
4	ENCLAD EN01 ALUMINIUM HORIZONTAL RAIL
5	ENCLAD EN01 ALUMINIUM TILE CLIP
6	ENCLAD TILE FIXING (STAINLESS STEEL)
7	ENCLAD BRACKET TO RAIL FIXING (STAINLESS STEEL)
8	ENCLAD RAIL TO RAIL FIXING (STAINLESS STEEL)
9	ENCLAD HOST STRUCTURAL FIXING (STAINLESS STEEL)
10	ENCLAD THERMAL ISOLATION PAD
11	ENCLAD ALUMINIUM CLOSURE
12	CAVITY INSULATION (OPTION BY INSITE)
13	BUILDING WRAP / MEMBRANE (OPTION BY INSITE)
14	RIGID AIR BARRIER / SHEATHING BOARD (OPTION BY INSITE)
15	WALL INSULATION (BY OTHERS)
16	PLASTER BOARD (BY OTHERS)

Cladding Type :

**ENCLAD™ PORCELAIN TILES**

Support System :

**ENCLAD™ EN03 - HOOK ON SECRET FIXED**

Detail Description :

CONCRETE WALL ABUTMENT DETAIL (PLAN VIEW)

Scale @ A3 : 1:2.5

Rev. : NOV 2022

System # :

PORC-EN03-HOR-SF5

Detail # :

09

**ENCLAD™ RAINSCREEN SYSTEMS**

**LEGEND**

A	ENCLAD™ PORCELAIN TILES
B	36mm - 51mm NOMINAL VENTILATION ZONE (AIR GAP)
C	* 101mm SYSTEM CAVITY TO ACCOMMODATE 50mm THICK INSULATION
D	* 50mm INSULATION (OPTION BY INSITE) FIRE STOP (OPTION BY INSITE)
*	OTHER OPTIONS AVAILABLE (PROJECT SPECIFIC) 111mm SYSTEM CAVITY FOR 75mm THICK INSULATION 136mm SYSTEM CAVITY FOR 100mm THICK INSULATION

**PARTS LIST**

1	ENCLAD™ PORCELAIN TILE
2	ENCLAD EN01 ALUMINIUM SUPPORT PROFILE
3	ENCLAD EN01 ALUMINIUM HELPING HAND BRACKET
4	ENCLAD EN01 ALUMINIUM HORIZONTAL RAIL
5	ENCLAD EN01 ALUMINIUM TILE CLIP
6	ENCLAD TILE FIXING (STAINLESS STEEL)
7	ENCLAD BRACKET TO RAIL FIXING (STAINLESS STEEL)
8	ENCLAD RAIL TO RAIL FIXING (STAINLESS STEEL)
9	ENCLAD HOST STRUCTURAL FIXING (STAINLESS STEEL)
10	ENCLAD THERMAL ISOLATION PAD
11	ENCLAD HEIGHT ADJUSTMENT BOLT & DL FIXING SCREW TO LOCK OFF (STAINLESS STEEL)
12	CAVITY INSULATION (OPTION BY INSITE)
13	BUILDING WRAP / MEMBRANE (OPTION BY INSITE)
14	RIGID AIR BARRIER / SHEATHING BOARD (OPTION BY INSITE)
15	WALL INSULATION (BY OTHERS)
16	PLASTER BOARD (BY OTHERS)

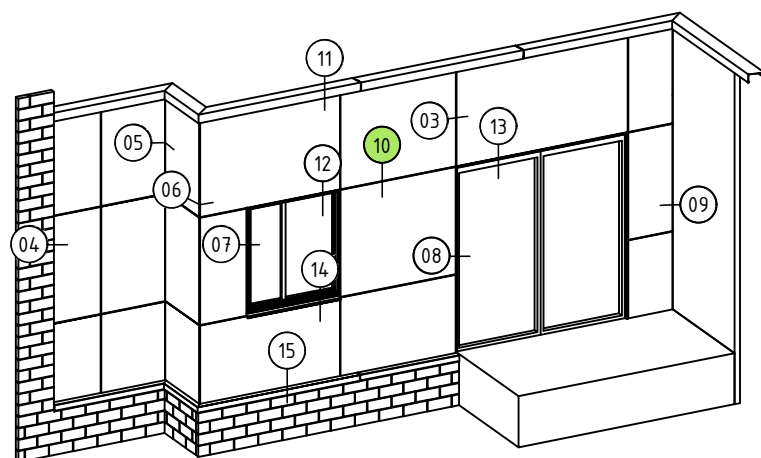
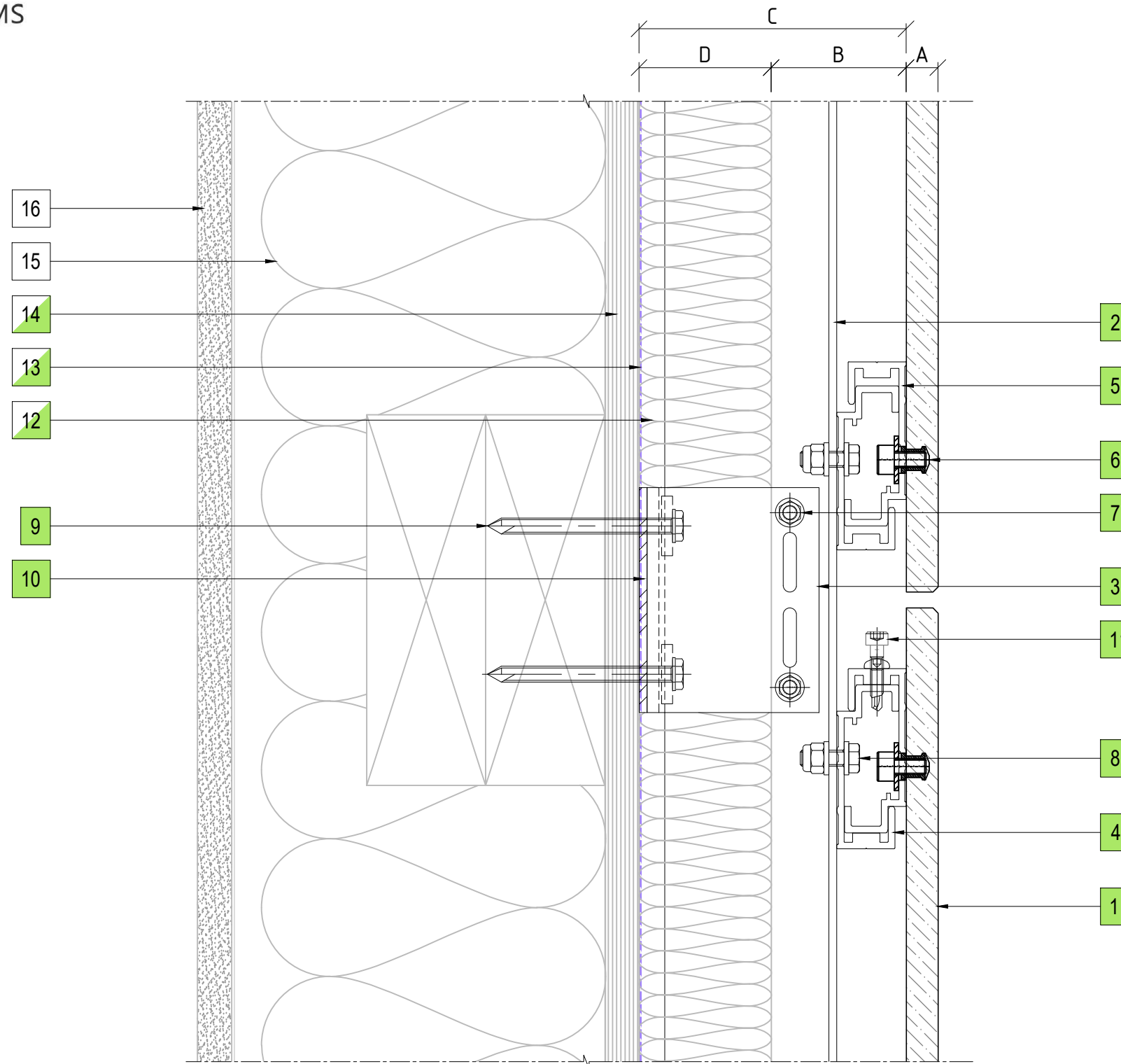

10 HORIZONTAL PANEL JOINT DETAIL  
ENCLAD™ PORCELAIN TILES

Cladding Type :

**ENCLAD™ PORCELAIN TILES**

Support System :

**ENCLAD™ EN03 - HOOK ON SECRET FIXED**

Detail Description :

**HORIZONTAL PANEL JOINT DETAIL (SECTION VIEW)**

Scale @ A3 : 1:2

Rev. : NOV 2022

System # :

**PORC-EN03-HOR-SF5**

Detail # :

**10**

**ENCLAD™ RAINSCREEN SYSTEMS**

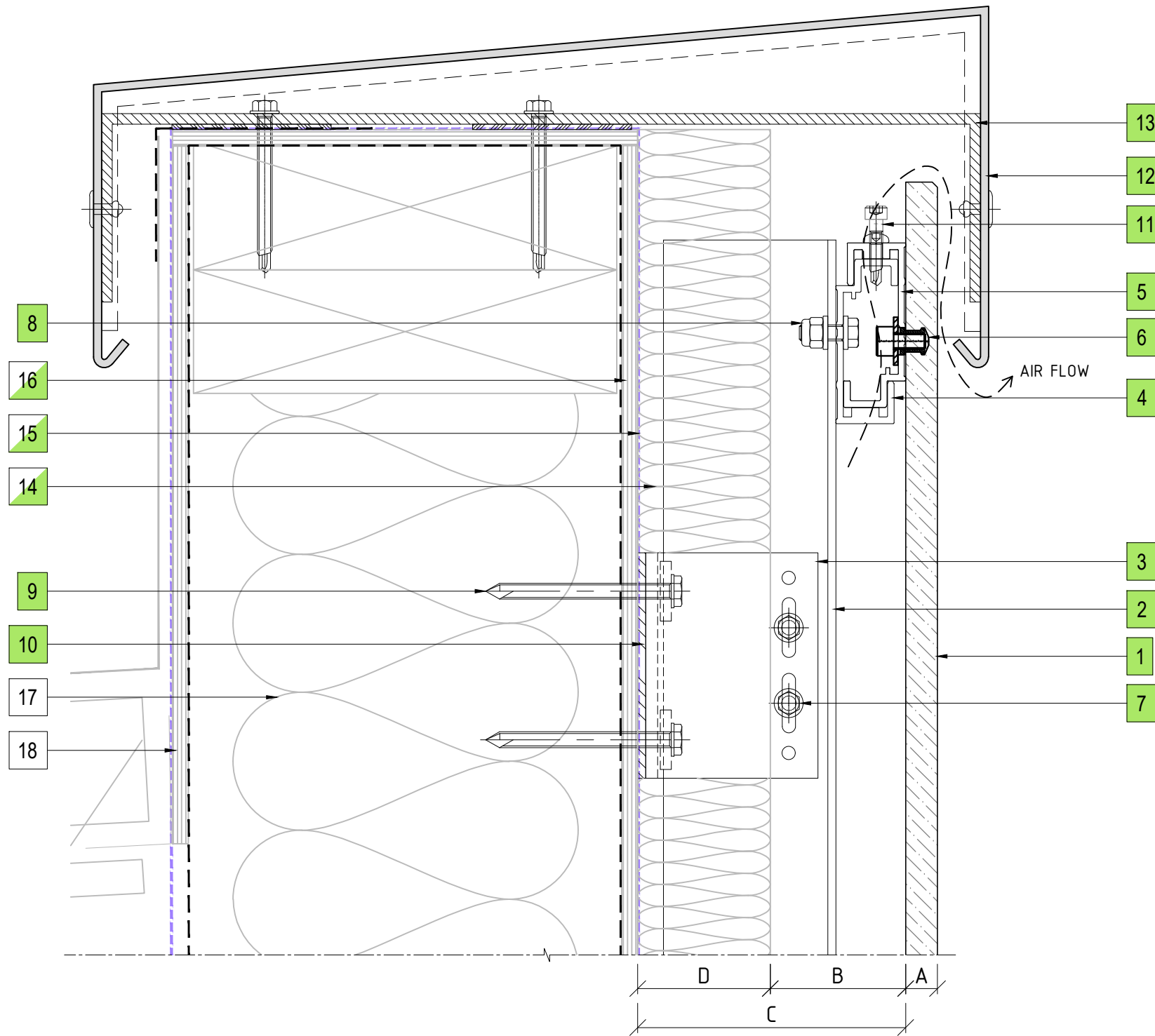

LEGEND	
A	ENCLAD™ PORCELAIN TILES
B	36mm - 51mm NOMINAL VENTILATION ZONE (AIR GAP)
C	* 101mm SYSTEM CAVITY TO ACCOMMODATE 50mm THICK INSULATION
D	* 50mm INSULATION (OPTION BY INSITE) FIRE STOP (OPTION BY INSITE)
*	OTHER OPTIONS AVAILABLE (PROJECT SPECIFIC) 111mm SYSTEM CAVITY FOR 75mm THICK INSULATION 136mm SYSTEM CAVITY FOR 100mm THICK INSULATION

PARTS LIST	
1	ENCLAD™ PORCELAIN TILE
2	ENCLAD EN01 ALUMINIUM SUPPORT PROFILE
3	ENCLAD EN01 ALUMINIUM HELPING HAND BRACKET
4	ENCLAD EN01 ALUMINIUM HORIZONTAL RAIL
5	ENCLAD EN01 ALUMINIUM TILE CLIP
6	ENCLAD TILE FIXING (STAINLESS STEEL)
7	ENCLAD BRACKET TO RAIL FIXING (STAINLESS STEEL)
8	ENCLAD RAIL TO RAIL FIXING (STAINLESS STEEL)
9	ENCLAD HOST STRUCTURAL FIXING (STAINLESS STEEL)
10	ENCLAD THERMAL ISOLATION PAD
11	ENCLAD HEIGHT ADJUSTMENT BOLT & DL FIXING SCREW TO LOCK OFF (STAINLESS STEEL)
12	ENCLAD ALUMINIUM FLASHING
13	ENCLAD ALUMINIUM BRACKET
14	CAVITY INSULATION (OPTION BY INSITE)
15	BUILDING WRAP / MEMBRANE (OPTION BY INSITE)
16	RIGID AIR BARRIER / SHEATHING BOARD (OPTION BY INSITE)
17	WALL INSULATION (BY OTHERS)
18	PLASTER BOARD (BY OTHERS)

Cladding Type :  
**ENCLAD™ PORCELAIN TILES**

Support System :  
**ENCLAD™ EN03 - HOOK ON SECRET FIXED**

Detail Description :  
**PARAPET FLASHING DETAIL (SECTION VIEW)**

Scale @ A3 : 1:2  
Rev. : NOV 2022

System # :  
PORC-EN03-HOR-SF5  
Detail # :  
**11**

**ENCLAD™ RAINSCREEN SYSTEMS**

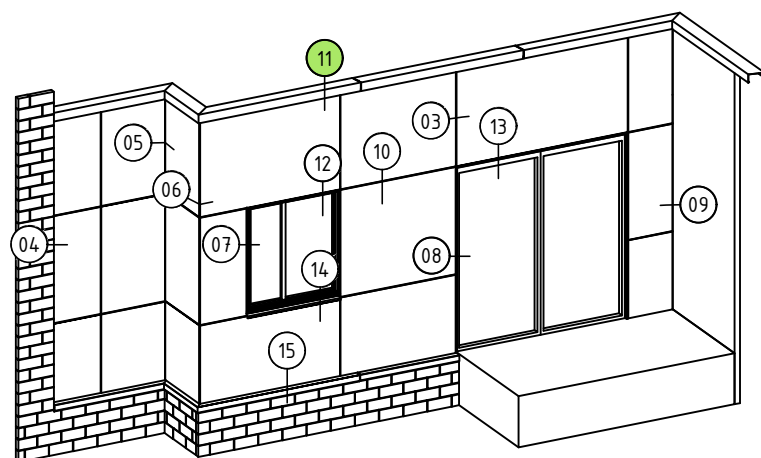

**11** PARAPET FLASHING DETAIL  
ENCLAD™ PORCELAIN TILES

**LEGEND**

A	ENCLAD™ PORCELAIN TILES
B	36mm - 51mm NOMINAL VENTILATION ZONE (AIR GAP)
C	* 101mm SYSTEM CAVITY TO ACCOMMODATE 50mm THICK INSULATION
D	* 50mm INSULATION (OPTION BY INSITE) FIRE STOP (OPTION BY INSITE)
*	OTHER OPTIONS AVAILABLE (PROJECT SPECIFIC) 111mm SYSTEM CAVITY FOR 75mm THICK INSULATION 136mm SYSTEM CAVITY FOR 100mm THICK INSULATION

**PARTS LIST**

1	ENCLAD™ PORCELAIN TILE
2	ENCLAD EN01 ALUMINIUM SUPPORT PROFILE
3	ENCLAD EN01 ALUMINIUM HELPING HAND BRACKET
4	ENCLAD EN01 ALUMINIUM HORIZONTAL RAIL
5	ENCLAD EN01 ALUMINIUM TILE CLIP
6	ENCLAD TILE FIXING (STAINLESS STEEL)
7	ENCLAD BRACKET TO RAIL FIXING (STAINLESS STEEL)
8	ENCLAD RAIL TO RAIL FIXING (STAINLESS STEEL)
9	ENCLAD HOST STRUCTURAL FIXING (STAINLESS STEEL)
10	ENCLAD THERMAL ISOLATION PAD
11	ENCLAD ALUMINIUM FLASHING
12	CAVITY INSULATION (OPTION BY INSITE)
13	BUILDING WRAP / MEMBRANE (OPTION BY INSITE)
14	RIGID AIR BARRIER / SHEATHING BOARD (OPTION BY INSITE)
15	ALUMINIUM DOORS, WINDOWS & REVEALS (OPTION BY INSITE)
16	WALL INSULATION (BY OTHERS)
17	PLASTER BOARD (BY OTHERS)

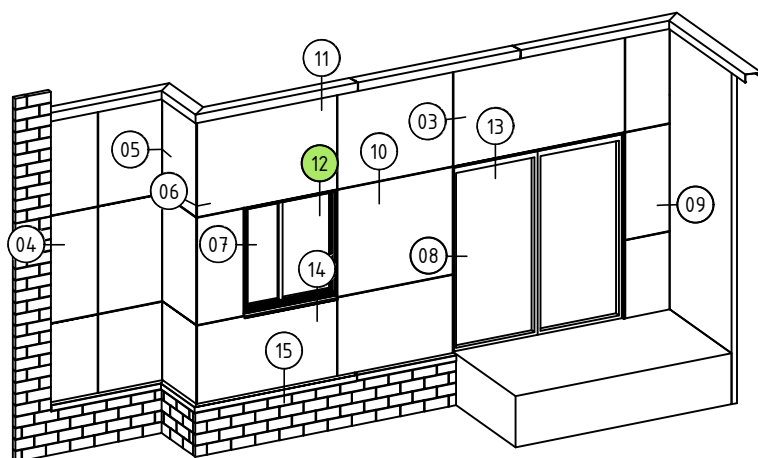
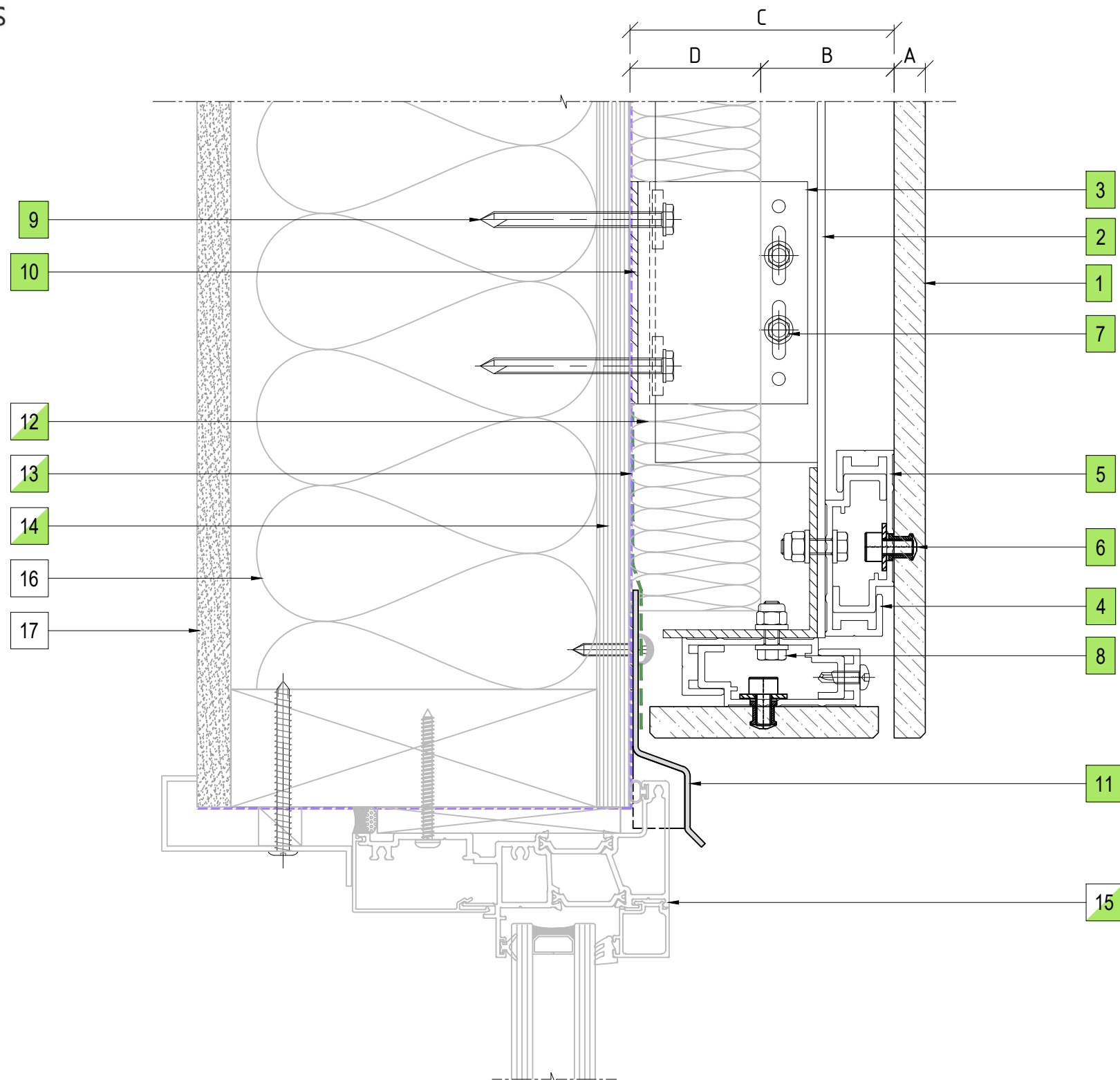

12 WINDOW HEAD DETAIL  
ENCLAD™ PORCELAIN TILES

Cladding Type :

**ENCLAD™ PORCELAIN TILES**

Support System :

**ENCLAD™ EN03 - HOOK ON SECRET FIXED**

Detail Description :

WINDOW HEAD DETAIL (SECTION VIEW)

Scale @ A3 : 1:2

Rev. : NOV 2022

System # :

PORC-EN03-HOR-SF5

Detail # :

12

**ENCLAD™ RAINSCREEN SYSTEMS**

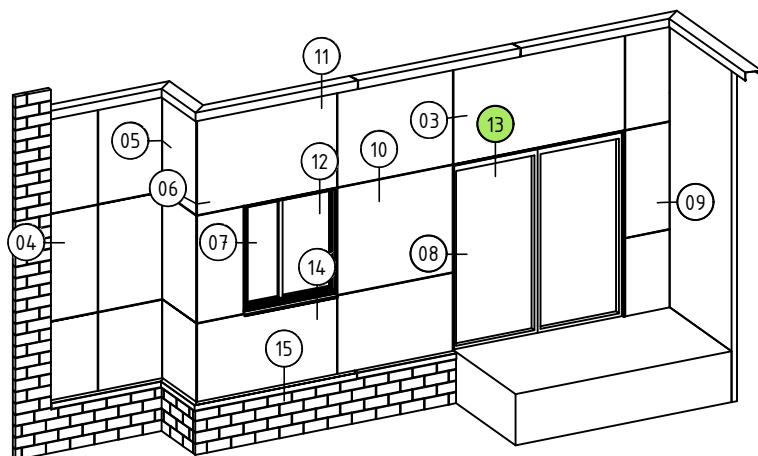
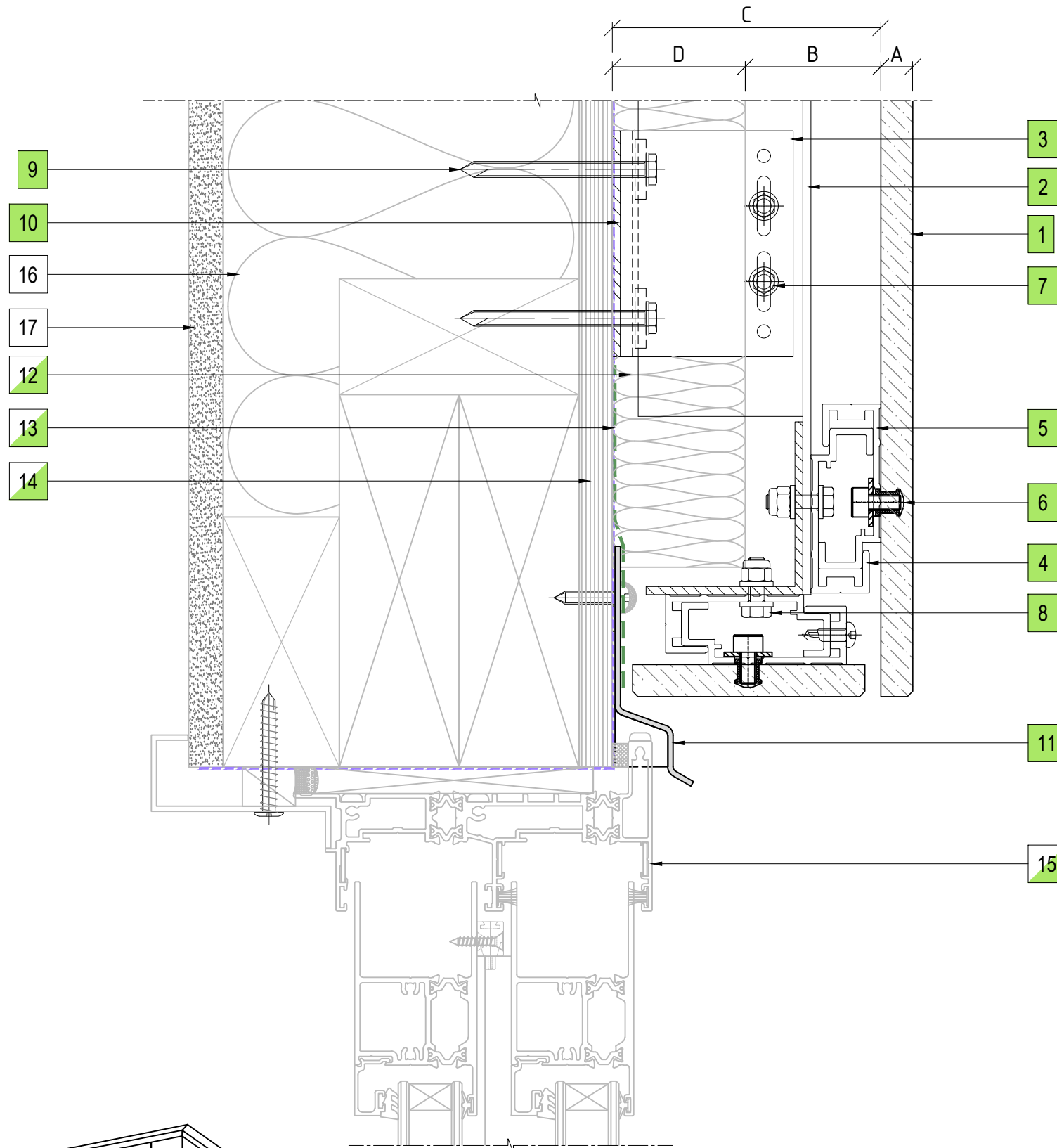

13 DOOR HEAD DETAIL  
ENCLAD™ PORCELAIN TILES

**LEGEND**

A	ENCLAD™ PORCELAIN TILES
B	36mm - 51mm NOMINAL VENTILATION ZONE (AIR GAP)
C	* 101mm SYSTEM CAVITY TO ACCOMMODATE 50mm THICK INSULATION
D	* 50mm INSULATION (OPTION BY INSITE) FIRE STOP (OPTION BY INSITE)
*	OTHER OPTIONS AVAILABLE (PROJECT SPECIFIC) 111mm SYSTEM CAVITY FOR 75mm THICK INSULATION 136mm SYSTEM CAVITY FOR 100mm THICK INSULATION

**PARTS LIST**

1	ENCLAD™ PORCELAIN TILE
2	ENCLAD EN01 ALUMINIUM SUPPORT PROFILE
3	ENCLAD EN01 ALUMINIUM HELPING HAND BRACKET
4	ENCLAD EN01 ALUMINIUM HORIZONTAL RAIL
5	ENCLAD EN01 ALUMINIUM TILE CLIP
6	ENCLAD TILE FIXING (STAINLESS STEEL)
7	ENCLAD BRACKET TO RAIL FIXING (STAINLESS STEEL)
8	ENCLAD RAIL TO RAIL FIXING (STAINLESS STEEL)
9	ENCLAD HOST STRUCTURAL FIXING (STAINLESS STEEL)
10	ENCLAD THERMAL ISOLATION PAD
11	ENCLAD ALUMINIUM FLASHING
12	CAVITY INSULATION (OPTION BY INSITE)
13	BUILDING WRAP / MEMBRANE (OPTION BY INSITE)
14	RIGID AIR BARRIER / SHEATHING BOARD (OPTION BY INSITE)
15	ALUMINIUM DOORS, WINDOWS & REVEALS (OPTION BY INSITE)
16	WALL INSULATION (BY OTHERS)
17	PLASTER BOARD (BY OTHERS)

Cladding Type :

**ENCLAD™ PORCELAIN TILES**

Support System :

**ENCLAD™ EN03 - HOOK ON SECRET FIXED**

Detail Description :

**DOOR HEAD DETAIL (SECTION VIEW)**

Scale @ A3 : 1:2

Rev. : NOV 2022

System # :

**PORC-EN03-HOR-SF5**

Detail # :

**13**

**ENCLAD™ RAINSCREEN SYSTEMS**

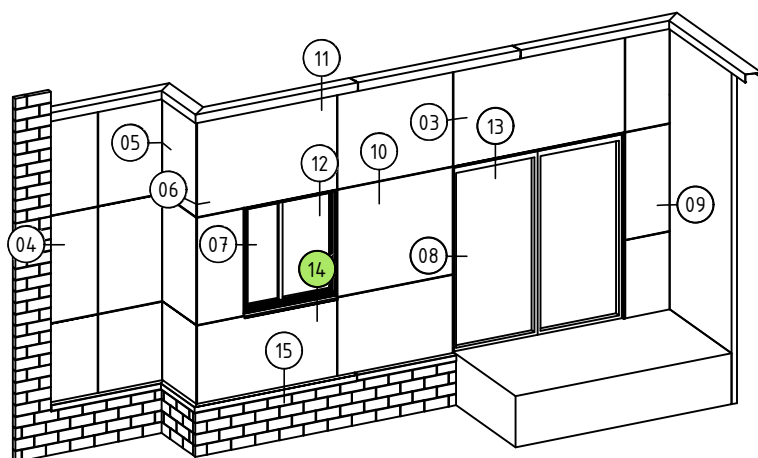
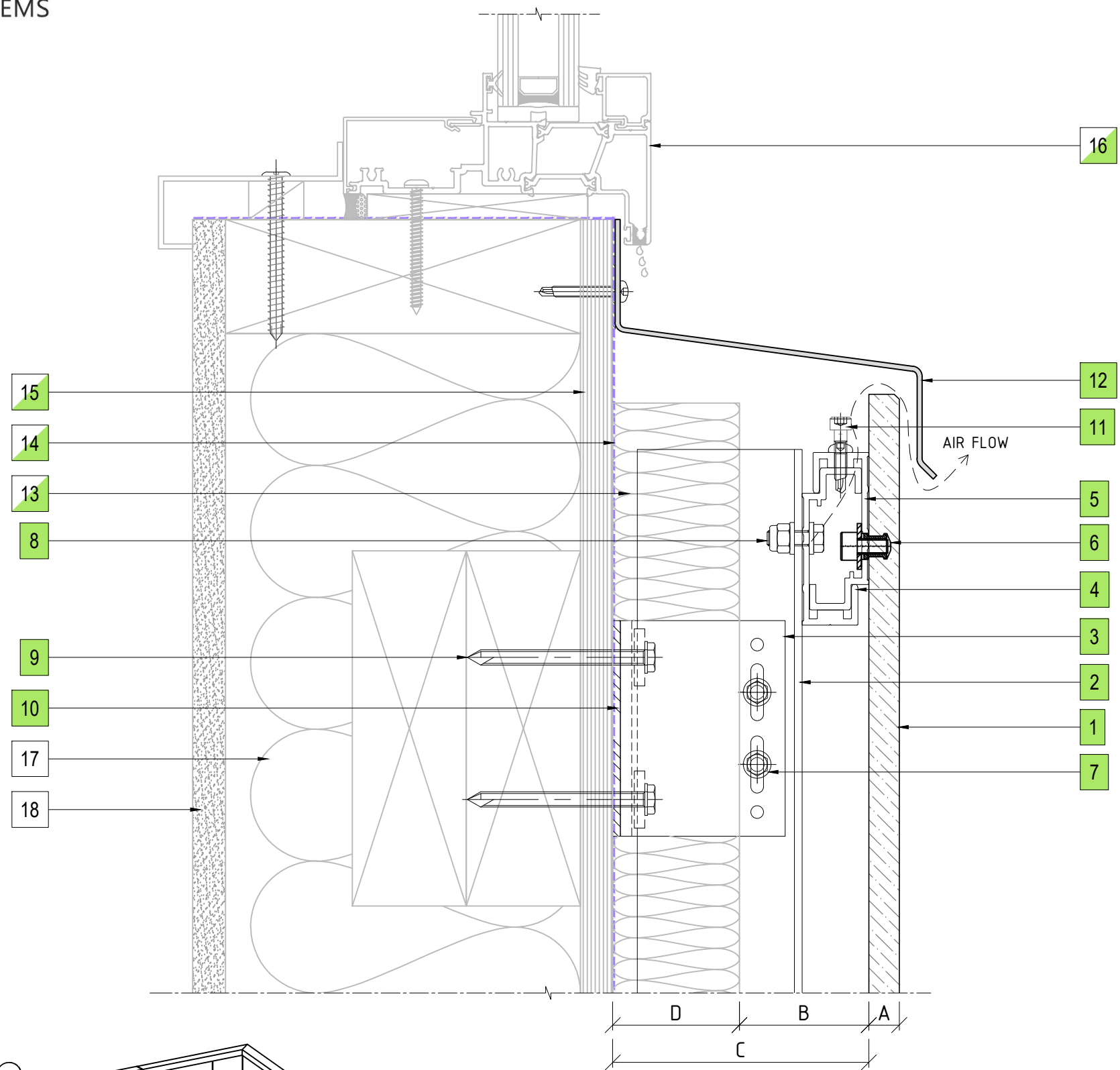

14 WINDOW SILL DETAIL  
ENCLAD™ PORCELAIN TILES

**LEGEND**

A	ENCLAD™ PORCELAIN TILES
B	36mm - 51mm NOMINAL VENTILATION ZONE (AIR GAP)
C	* 101mm SYSTEM CAVITY TO ACCOMMODATE 50mm THICK INSULATION
D	* 50mm INSULATION (OPTION BY INSITE) FIRE STOP (OPTION BY INSITE)
*	OTHER OPTIONS AVAILABLE (PROJECT SPECIFIC) 111mm SYSTEM CAVITY FOR 75mm THICK INSULATION 136mm SYSTEM CAVITY FOR 100mm THICK INSULATION

**PARTS LIST**

1	ENCLAD™ PORCELAIN TILE
2	ENCLAD EN01 ALUMINIUM SUPPORT PROFILE
3	ENCLAD EN01 ALUMINIUM HELPING HAND BRACKET
4	ENCLAD EN01 ALUMINIUM HORIZONTAL RAIL
5	ENCLAD EN01 ALUMINIUM TILE CLIP
6	ENCLAD TILE FIXING (STAINLESS STEEL)
7	ENCLAD BRACKET TO RAIL FIXING (STAINLESS STEEL)
8	ENCLAD RAIL TO RAIL FIXING (STAINLESS STEEL)
9	ENCLAD HOST STRUCTURAL FIXING (STAINLESS STEEL)
10	ENCLAD THERMAL ISOLATION PAD
11	ENCLAD HEIGHT ADJUSTMENT BOLT & DL FIXING SCREW TO LOCK OFF (STAINLESS STEEL)
12	ENCLAD ALUMINIUM FLASHING
13	CAVITY INSULATION (OPTION BY INSITE)
14	BUILDING WRAP / MEMBRANE (OPTION BY INSITE)
15	RIGID AIR BARRIER / SHEATHING BOARD (OPTION BY INSITE)
16	ALUMINIUM DOORS, WINDOWS & REVEALS (OPTION BY INSITE)
17	WALL INSULATION (BY OTHERS)
18	PLASTER BOARD (BY OTHERS)

Cladding Type :

**ENCLAD™ PORCELAIN TILES**

Support System :

**ENCLAD™ EN03 - HOOK ON SECRET FIXED**

Detail Description :

**WINDOW SILL DETAIL (SECTION VIEW)**

Scale @ A3 : 1:2

Rev. : NOV 2022

System # :

**PORC-EN03-HOR-SF5**

Detail # :

**14**

**ENCLAD™ RAINSCREEN SYSTEMS**

**LEGEND**

A	ENCLAD™ PORCELAIN TILES
B	36mm - 51mm NOMINAL VENTILATION ZONE (AIR GAP)
C	* 101mm SYSTEM CAVITY TO ACCOMMODATE 50mm THICK INSULATION
D	* 50mm INSULATION (OPTION BY INSITE) FIRE STOP (OPTION BY INSITE)
*	OTHER OPTIONS AVAILABLE (PROJECT SPECIFIC) 111mm SYSTEM CAVITY FOR 75mm THICK INSULATION 136mm SYSTEM CAVITY FOR 100mm THICK INSULATION

**PARTS LIST**

1	ENCLAD™ PORCELAIN TILE
2	ENCLAD EN01 ALUMINIUM SUPPORT PROFILE
3	ENCLAD EN01 ALUMINIUM HELPING HAND BRACKET
4	ENCLAD EN01 ALUMINIUM HORIZONTAL RAIL
5	ENCLAD EN01 ALUMINIUM TILE CLIP
6	ENCLAD TILE FIXING (STAINLESS STEEL)
7	ENCLAD BRACKET TO RAIL FIXING (STAINLESS STEEL)
8	ENCLAD RAIL TO RAIL FIXING (STAINLESS STEEL)
9	ENCLAD HOST STRUCTURAL FIXING (STAINLESS STEEL)
10	ENCLAD THERMAL ISOLATION PAD
11	ENCLAD ALUMINIUM FLASHING
1*	CAVITY INSULATION (OPTION BY INSITE)
13	BUILDING WRAP / MEMBRANE (OPTION BY INSITE)
14	RIGID AIR BARRIER / SHEATHING BOARD (OPTION BY INSITE)
15	WALL INSULATION (BY OTHERS)
16	PLASTER BOARD (BY OTHERS)

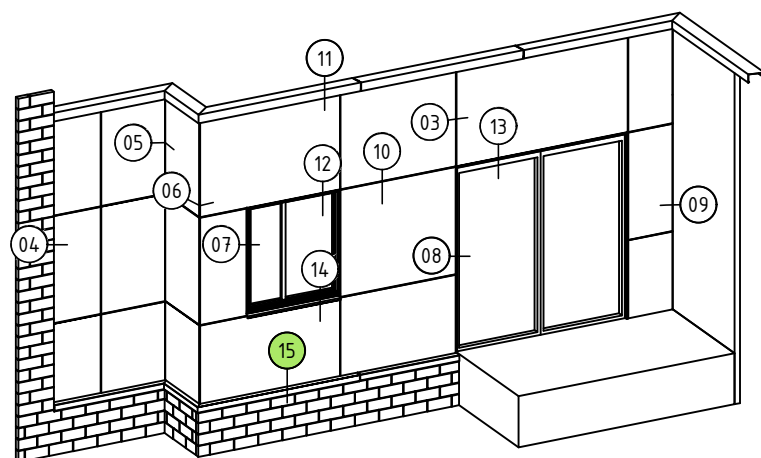
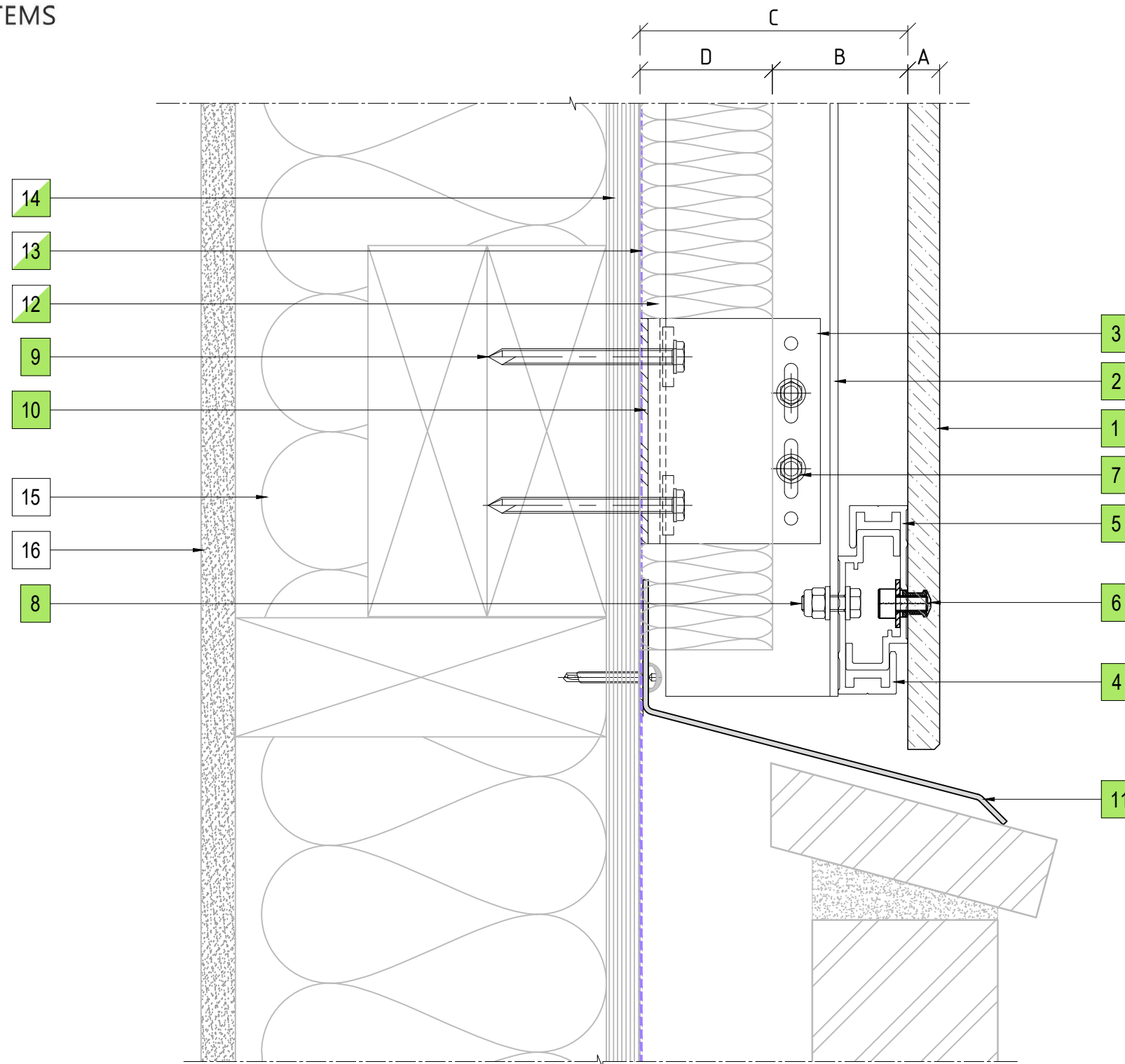

15 BRICKWALL AT BASE DRIP DETAIL  
ENCLAD™ PORCELAIN TILES

Cladding Type :

**ENCLAD™ PORCELAIN TILES**

Support System :

**ENCLAD™ EN03 - HOOK ON SECRET FIXED**

Detail Description :

**BRICKWALL AT BASE DRIP DETAIL (SECTION VIEW)**

Scale @ A3 : 1:2

Rev. : NOV 2022

System # :

**PORC-EN03-HOR-SF5**

Detail # :

**15**

**ENCLAD™ RAINSCREEN SYSTEMS**