

ENCLAD™ PORCELAIN TILES

ENCLAD™ EN05-FF SUPPORT SYSTEM

HOOK ON SECRET FIXED

DRAWING REGISTER

PAGE	DETAIL DESCRIPTION	DETAIL #	REV.
00/16	COVER PAGE	00	NOV 22
01/16	CAVITY SET OUT	01	NOV 22
02/16	SCHEMATIC	02	NOV 22
03/16	VERTICAL PANEL JOINT DETAIL (PLAN VIEW)	03	NOV 22
04/16	BRICKWALL ABUTMENT DETAIL (PLAN VIEW)	04	NOV 22
05/16	INTERNAL CORNER PANEL DETAIL (PLAN VIEW)	05	NOV 22
06/16	EXTERNAL CORNER PANEL DETAIL (PLAN VIEW)	06	NOV 22
07/16	WINDOW JAMB DETAIL (PLAN VIEW)	07	NOV 22
08/16	DOOR JAMB DETAIL (PLAN VIEW)	08	NOV 22
09/16	CONCRETE WALL ABUTMENT DETAIL (PLAN VIEW)	09	NOV 22
10/16	HORIZONTAL PANEL JOINT DETAIL (SECTION VIEW)	10	NOV 22
11/16	PARAPET FLASHING DETAIL (SECTION VIEW)	11	NOV 22
12/16	WINDOW HEAD DETAIL (SECTION VIEW)	12	NOV 22
13/16	DOOR HEAD DETAIL (SECTION VIEW)	13	NOV 22
14/16	WINDOW SILL DETAIL (SECTION VIEW)	14	NOV 22
15/16	BRICKWALL AT BASE DRIP DETAIL (SECTION VIEW)	15	NOV 22
16/16	FLOOR TO FLOOR PANEL JOINT (PLAN & SECTION VIEW)	16	NOV 22

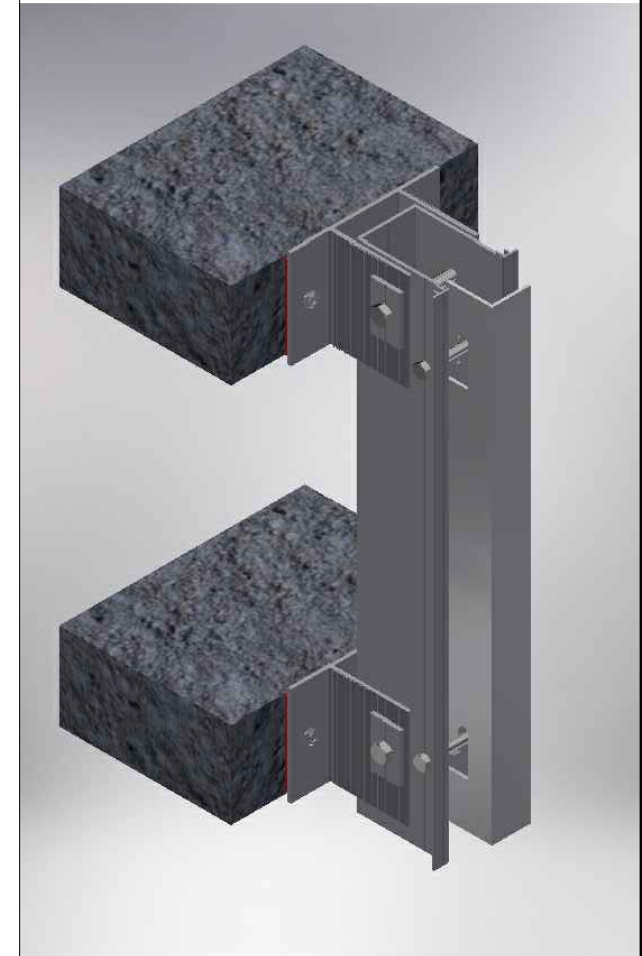

Cladding Type :

ENCLAD™ PORCELAIN TILES

Support System :

ENCLAD™ EN05-FF - HOOK ON SECRET FIXED

Detail Description :

COVER PAGE

Scale @ A3 :

Rev. : NOV 2022

System # :

PORC-EN05-FF-HOE-SF6

Detail # :

00

ENCLAD™ RAINSCREEN SYSTEMS

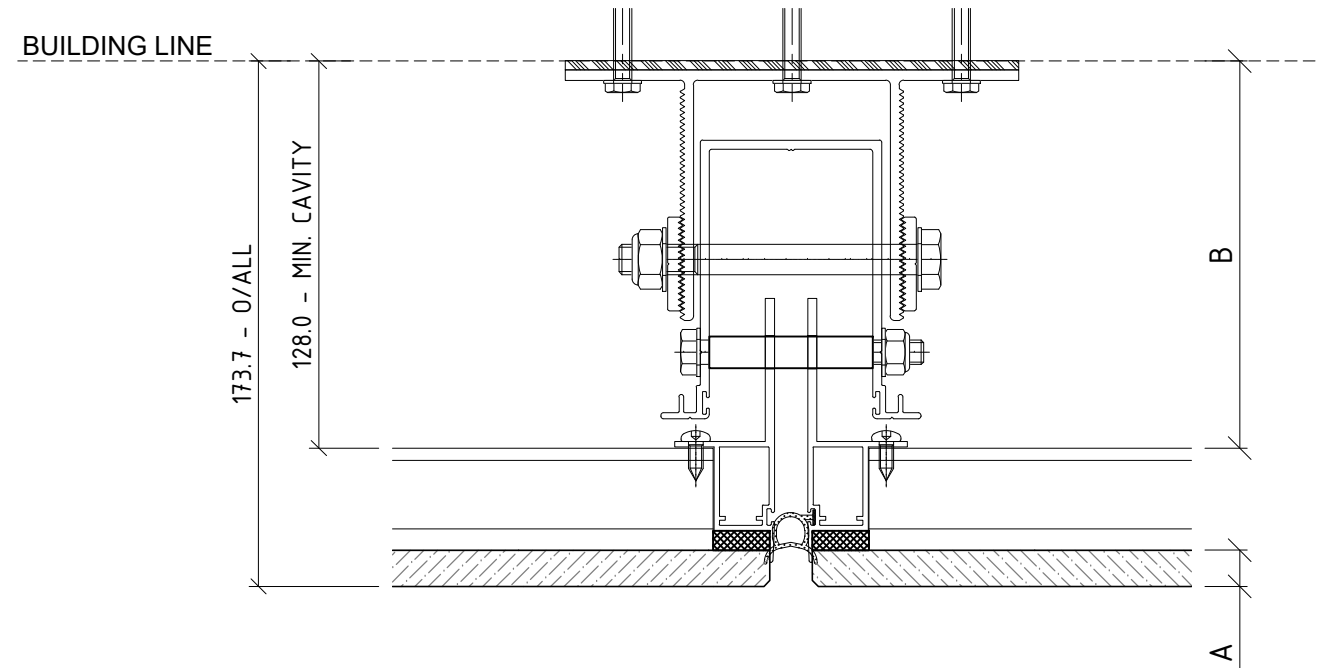

EN05 - FF
MINIMUM SYSTEM CAVITY 128mm

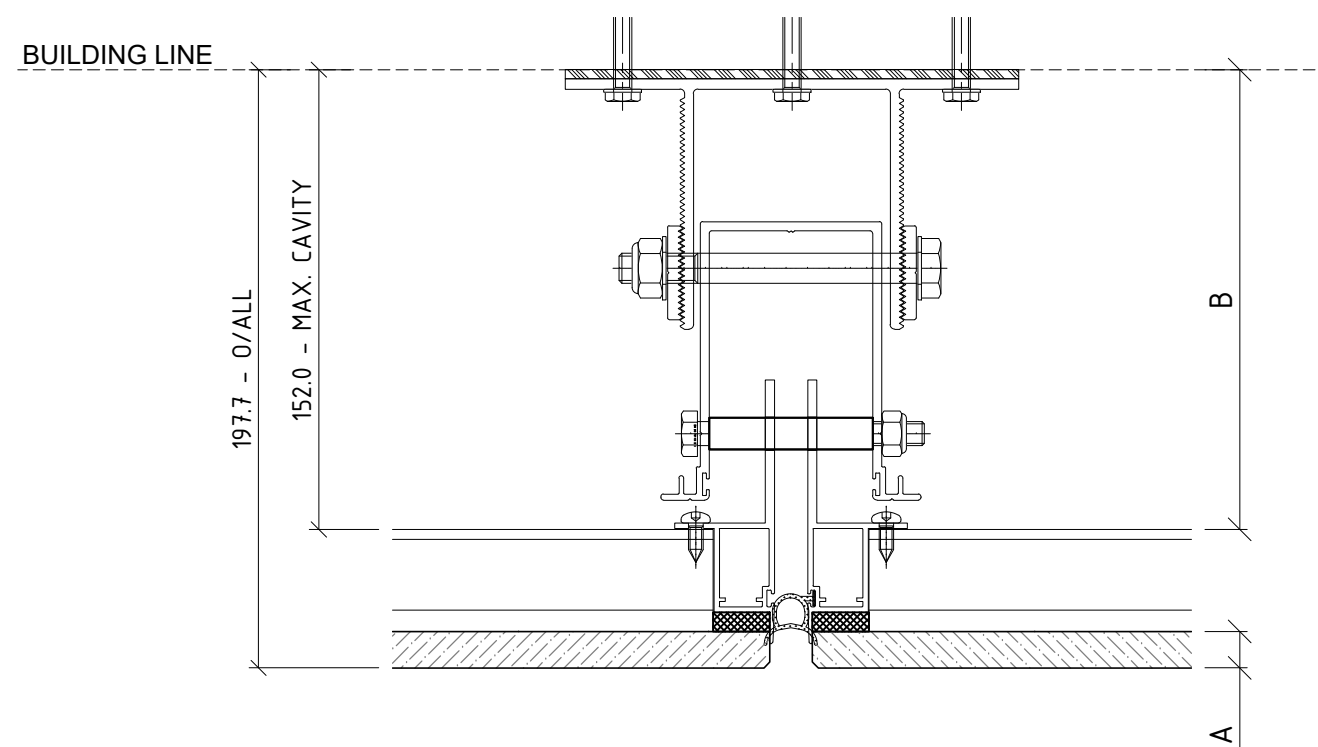

EN05 - FF
MAXIMUM SYSTEM CAVITY 152mm

01 CAVITY SET OUT
ENCLAD™ PORCELAIN TILES

LEGEND	
A	ENCLAD™ PORCELAIN TILES
B	* SYSTEM CAVITY (128mm MIN. - 152mm MAX.)
*	OTHER OPTIONS AVAILABLE (PROJECT SPECIFIC)

Cladding Type : ENCLAD™ PORCELAIN TILES	
Support System : ENCLAD™ EN05-FF - HOOK ON SECRET FIXED	
Detail Description : CAVITY SETOUT (PLAN VIEW)	
Scale @ A3 : 1:2.5	Rev. : NOV 2022
System # : PORC-EN05-FF-HOE-SF6	Detail # : 01

ENCLAD™ RAINSCREEN SYSTEMS

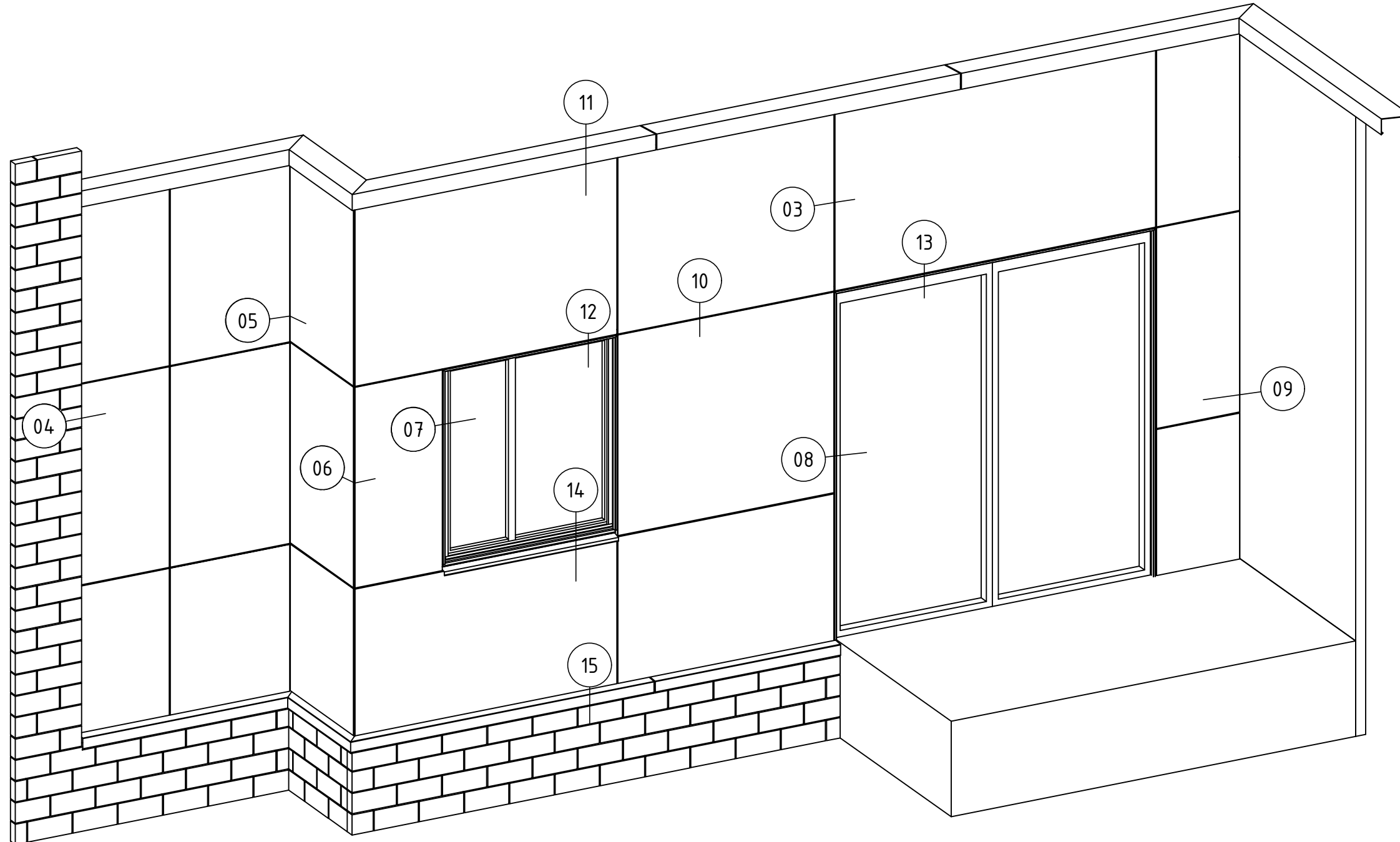

02 SCHEMATIC
ENCLAD™ PORCELAIN TILES

Cladding Type :
ENCLAD™ PORCELAIN TILES

Support System :
ENCLAD™ EN05-FF - HOOK ON SECRET FIXED

Detail Description :
SCHEMATIC

Scale @ A3 : 1:5

Rev. : NOV 2022

System # :
PORC-EN05-FF-HOE-SF6

Detail # :
02

ENCLAD™ RAINSCREEN SYSTEMS

LEGEND

A	ENCLAD™ PORCELAIN TILES
B	* SYSTEM CAVITY (128mm MIN. - 152mm MAX.)
*	OTHER OPTIONS AVAILABLE (PROJECT SPECIFIC)

PARTS LIST

1	ENCLAD™ PORCELAIN TILE
2	ENCLAD EN01 ALUMINIUM SUPPORT PROFILE
3	ENCLAD EN01 ALUMINIUM STRONG BACK PROFILE
4	ENCLAD EN01 ALUMINIUM CHANNEL PROFILE
5	ENCLAD FIXING FOR HOOK (STAINLESS STEEL)
6	ENCLAD ALUMINIUM CLOSURE
7	ENCLAD FIXING FOR CHANNEL PROFILE (STAINLESS STEEL)
8	ENCLAD HOST STRUCTURAL FIXING (STAINLESS STEEL)
9	ENCLAD THERMAL ISOLATION PAD
10	BUILDING WRAP / MEMBRANE (OPTION BY INSITE)
11	RIGID AIR BARRIER / SHEATHING BOARD (OPTION BY INSITE)
12	WALL INSULATION (BY OTHERS)
13	PLASTER BOARD (BY OTHERS)

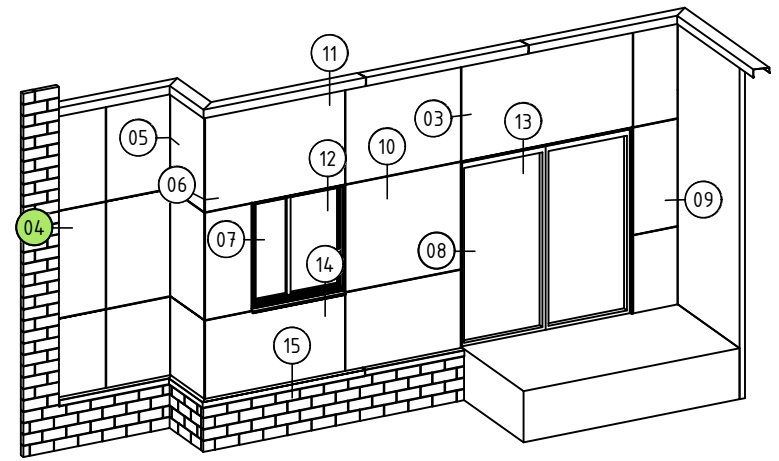
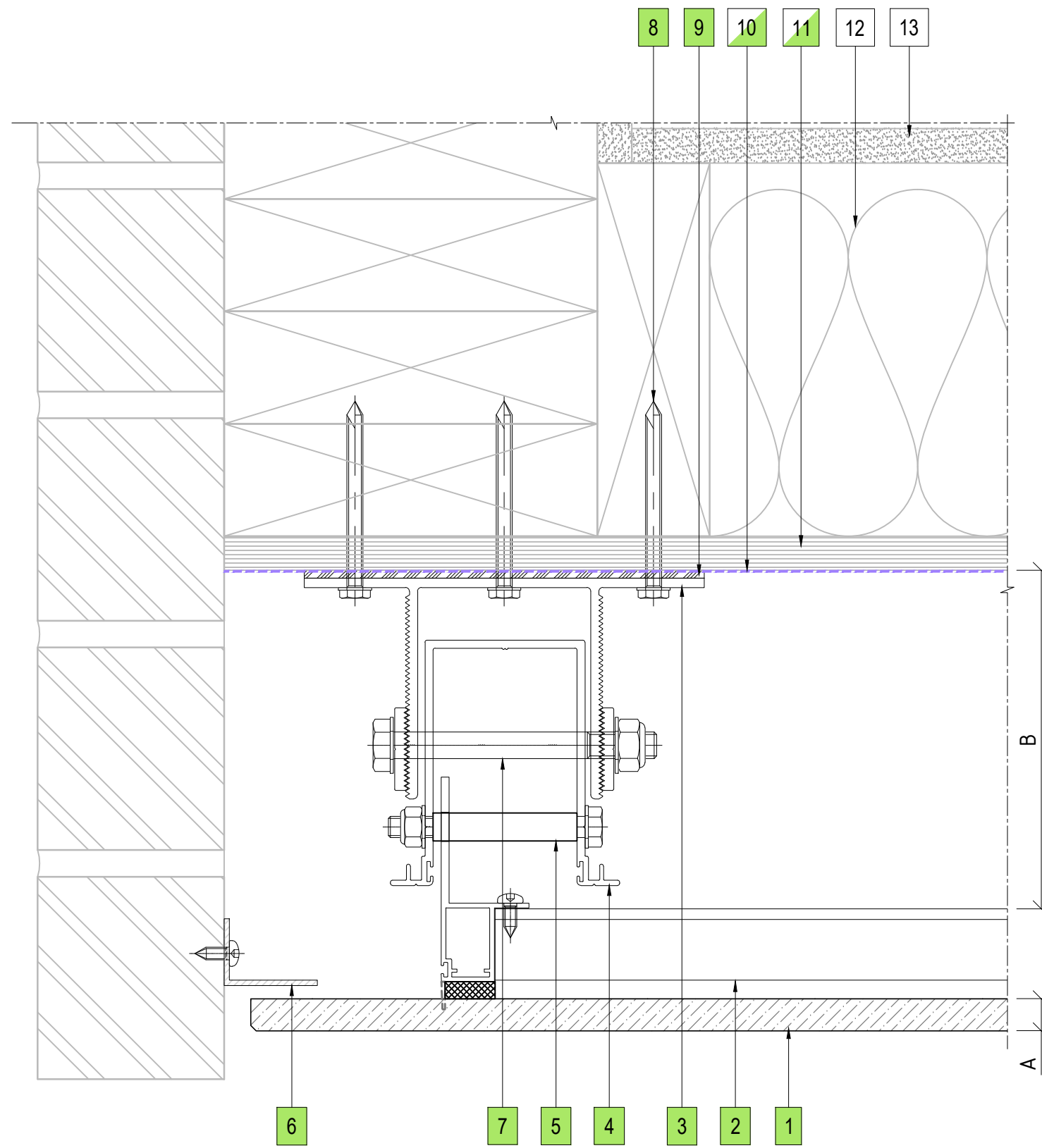

04 BRICKWALL ABUTMENT DETAIL
ENCLAD™ PORCELAIN TILES

Cladding Type :
ENCLAD™ PORCELAIN TILES

Support System :
ENCLAD™ EN05-FF - HOOK ON SECRET FIXED

Detail Description :
BRICKWALL ABUTMENT DETAIL (PLAN VIEW)

Scale @ A3 : 1:2

Rev. : NOV 2022

System # :
PORC-EN05-FF-HOE-SF6

Detail # :
04

ENCLAD™ RAINSCREEN SYSTEMS

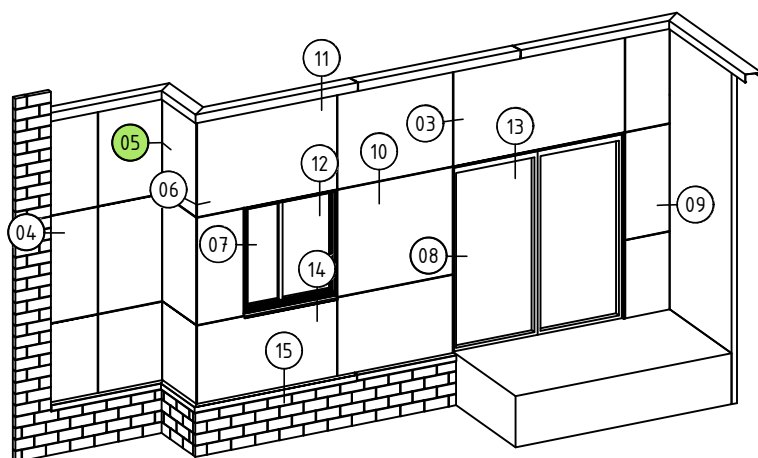
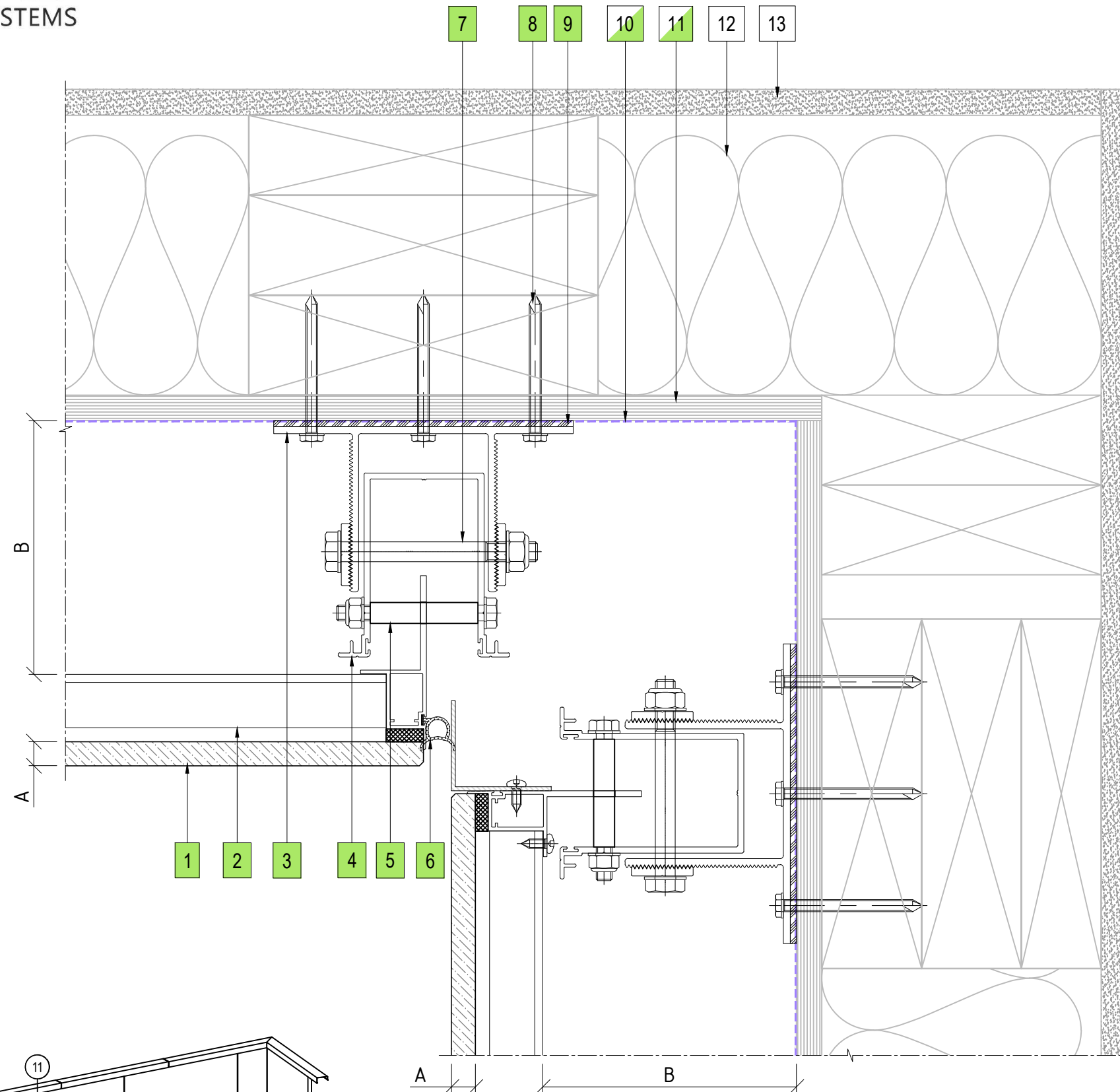

05 INTERNAL CORNER PANEL DETAIL
ENCLAD™ PORCELAIN TILES

LEGEND

A	ENCLAD™ PORCELAIN TILES
B	* SYSTEM CAVITY (128mm MIN. - 152mm MAX.)
*	OTHER OPTIONS AVAILABLE (PROJECT SPECIFIC)

PARTS LIST

1	ENCLAD™ PORCELAIN TILE
2	ENCLAD EN01 ALUMINIUM SUPPORT PROFILE
3	ENCLAD EN01 ALUMINIUM STRONG BACK PROFILE
4	ENCLAD EN01 ALUMINIUM CHANNEL PROFILE
5	ENCLAD FIXING FOR HOOK (STAINLESS STEEL)
6	ENCLAD GASKET
7	ENCLAD FIXING FOR CHANNEL PROFILE (STAINLESS STEEL)
8	ENCLAD HOST STRUCTURAL FIXING (STAINLESS STEEL)
9	ENCLAD THERMAL ISOLATION PAD
10	BUILDING WRAP / MEMBRANE (OPTION BY INSITE)
11	RIGID AIR BARRIER / SHEATHING BOARD (OPTION BY INSITE)
12	WALL INSULATION (BY OTHERS)
13	PLASTER BOARD (BY OTHERS)

Cladding Type :
ENCLAD™ PORCELAIN TILES

Support System :
ENCLAD™ EN05-FF - HOOK ON SECRET FIXED

Detail Description :
INTERNAL CORNER PANEL DETAIL (PLAN VIEW)

Scale @ A3 : 1:2.5

Rev. : NOV 2022

System # :
PORC-EN05-FF-HOE-SF6

Detail # :
05

ENCLAD™ RAINSCREEN SYSTEMS

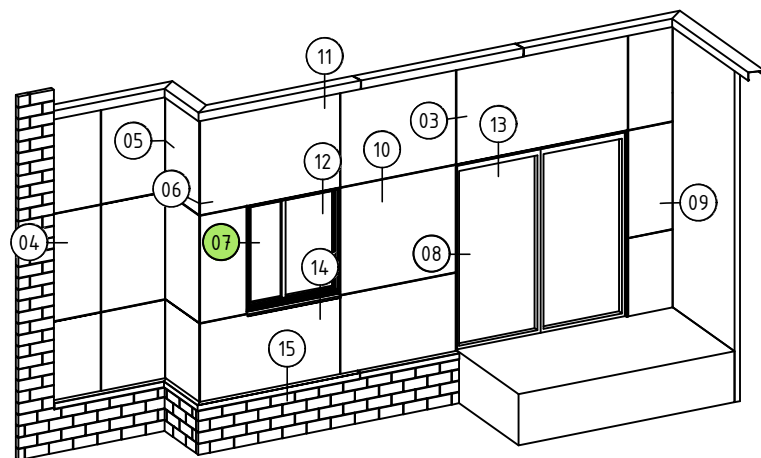
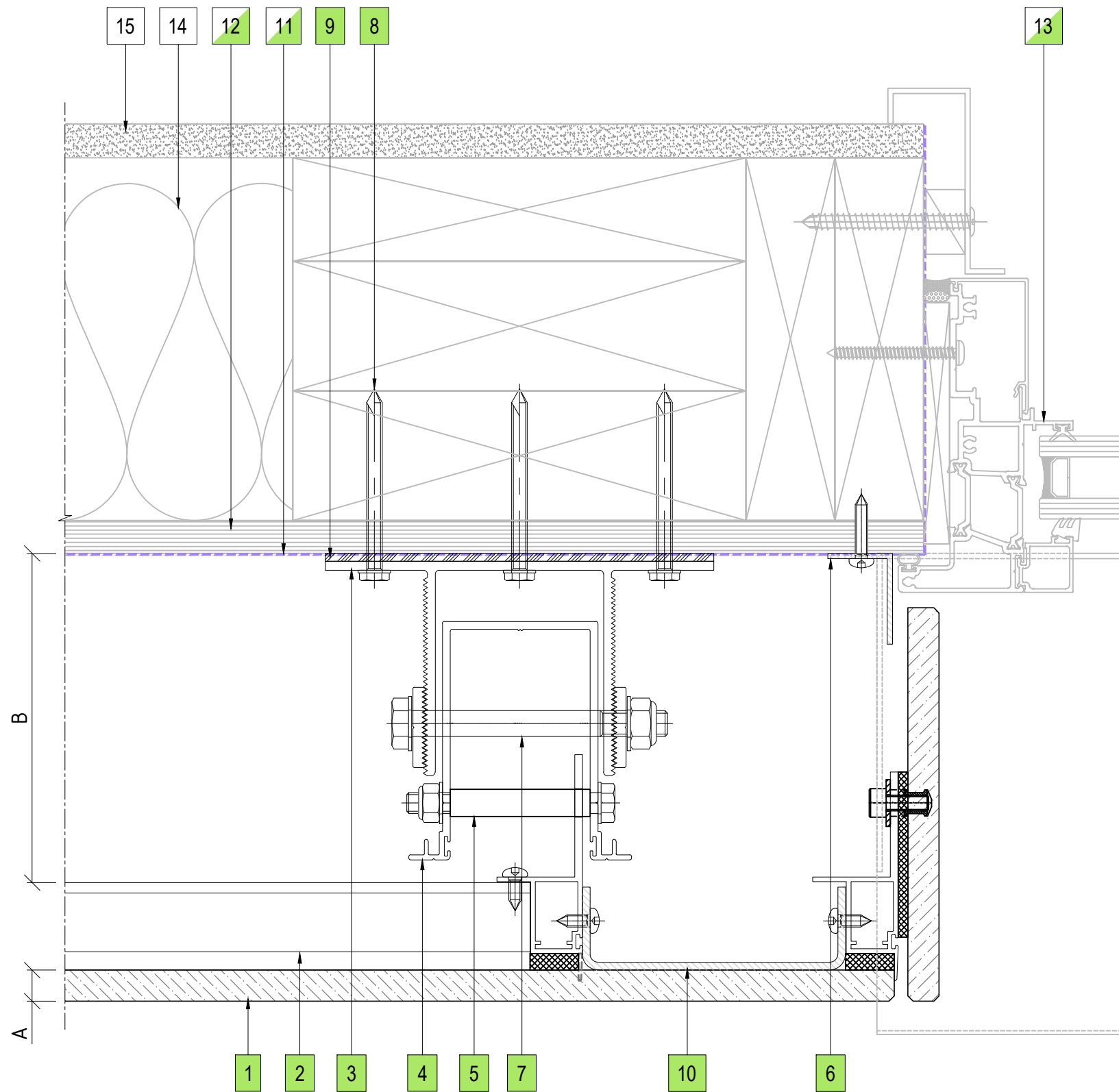

07 WINDOW JAMB DETAIL
ENCLAD™ PORCELAIN TILES

LEGEND

A	ENCLAD™ PORCELAIN TILES
B	* SYSTEM CAVITY (128mm MIN. - 152mm MAX.)
*	OTHER OPTIONS AVAILABLE (PROJECT SPECIFIC)

PARTS LIST

1	ENCLAD™ PORCELAIN TILE
2	ENCLAD EN01 ALUMINIUM SUPPORT PROFILE
3	ENCLAD EN01 ALUMINIUM STRONG BACK PROFILE
4	ENCLAD EN01 ALUMINIUM CHANNEL PROFILE
5	ENCLAD FIXING FOR HOOK (STAINLESS STEEL)
6	ENCLAD ALUMINIUM CLOSURE
7	ENCLAD FIXING FOR CHANNEL PROFILE (STAINLESS STEEL)
8	ENCLAD HOST STRUCTURAL FIXING (STAINLESS STEEL)
9	ENCLAD THERMAL ISOLATION PAD
10	ENCLAD ALUMINIUM SUPPORT PROFILE
11	BUILDING WRAP / MEMBRANE (OPTION BY INSITE)
12	RIGID AIR BARRIER / SHEATHING BOARD (OPTION BY INSITE)
13	ALUMINIUM DOORS, WINDOWS & REVEALS (OPTION BY INSITE)
14	WALL INSULATION (BY OTHERS)
15	PLASTER BOARD (BY OTHERS)

Cladding Type :

ENCLAD™ PORCELAIN TILES

Support System :

ENCLAD™ EN05-FF - HOOK ON SECRET FIXED

Detail Description :

WINDOW JAMB DETAIL (PLAN VIEW)

Scale @ A3 : 1:2

Rev. : NOV 2022

System # :

PORC-EN05-FF-HOE-SF6

Detail # :

07

ENCLAD™ RAINSCREEN SYSTEMS

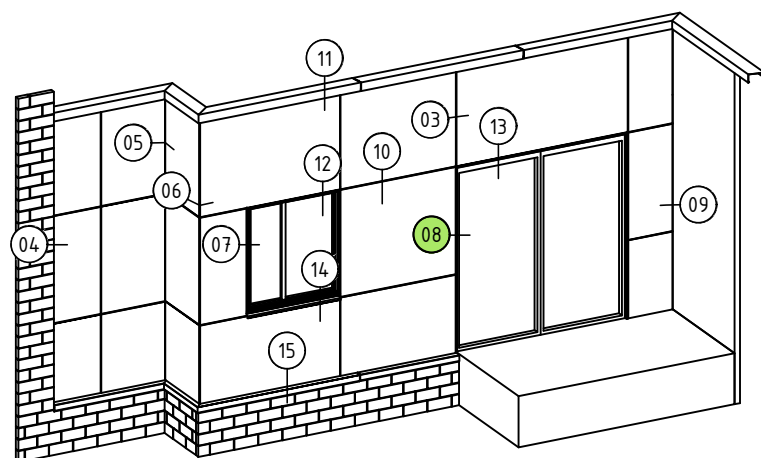
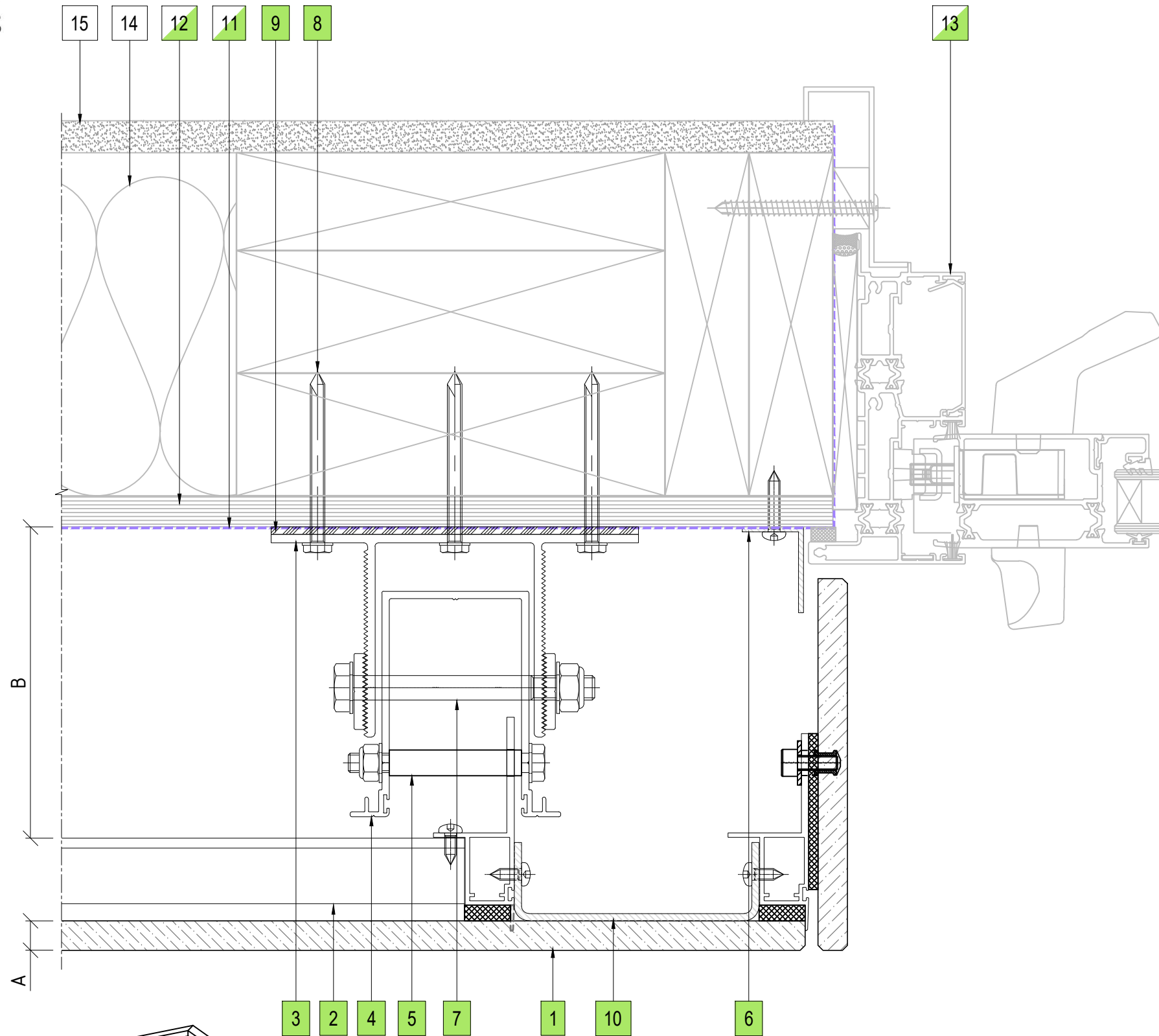

08 DOOR JAMB DETAIL
ENCLAD™ PORCELAIN TILES

LEGEND

A	ENCLAD™ PORCELAIN TILES
B	* SYSTEM CAVITY (128mm MIN. - 152mm MAX.)
*	OTHER OPTIONS AVAILABLE (PROJECT SPECIFIC)

PARTS LIST

1	ENCLAD™ PORCELAIN TILE
2	ENCLAD EN01 ALUMINIUM SUPPORT PROFILE
3	ENCLAD EN01 ALUMINIUM STRONG BACK PROFILE
4	ENCLAD EN01 ALUMINIUM CHANNEL PROFILE
5	ENCLAD FIXING FOR HOOK (STAINLESS STEEL)
6	ENCLAD ALUMINIUM CLOSURE
7	ENCLAD FIXING FOR CHANNEL PROFILE (STAINLESS STEEL)
8	ENCLAD HOST STRUCTURAL FIXING (STAINLESS STEEL)
9	ENCLAD THERMAL ISOLATION PAD
10	ENCLAD ALUMINIUM SUPPORT PROFILE
11	BUILDING WRAP / MEMBRANE (OPTION BY INSITE)
12	RIGID AIR BARRIER / SHEATHING BOARD (OPTION BY INSITE)
13	ALUMINIUM DOORS, WINDOWS & REVEALS (OPTION BY INSITE)
14	WALL INSULATION (BY OTHERS)
15	PLASTER BOARD (BY OTHERS)

Cladding Type :
ENCLAD™ PORCELAIN TILES

Support System :
ENCLAD™ EN05-FF - HOOK ON SECRET FIXED

Detail Description :
DOOR JAMB DETAIL (PLAN VIEW)

Scale @ A3 : 1:2

Rev. : NOV 2022

System # :
PORC-EN05-FF-HOE-SF6

Detail # :
08

ENCLAD™ RAINSCREEN SYSTEMS

LEGEND

A	ENCLAD™ PORCELAIN TILES
B	* SYSTEM CAVITY (128mm MIN. - 152mm MAX.)
*	OTHER OPTIONS AVAILABLE (PROJECT SPECIFIC)

PARTS LIST

1	ENCLAD™ PORCELAIN TILE
2	ENCLAD EN01 ALUMINIUM SUPPORT PROFILE
3	ENCLAD EN01 ALUMINIUM STRONG BACK PROFILE
4	ENCLAD EN01 ALUMINIUM CHANNEL PROFILE
5	ENCLAD FIXING FOR HOOK (STAINLESS STEEL)
6	ENCLAD FIXING FOR CHANNEL PROFILE (STAINLESS STEEL)
7	ENCLAD HOST STRUCTURAL FIXING (STAINLESS STEEL)
8	ENCLAD THERMAL ISOLATION PAD
9	ENCLAD ALUMINIUM FLASHING
10	ENCLAD ALUMINIUM BRACKET
11	BUILDING WRAP / MEMBRANE (OPTION BY INSITE)
12	RIGID AIR BARRIER / SHEATHING BOARD (OPTION BY INSITE)
13	WALL INSULATION (BY OTHERS)
14	PLASTER BOARD (BY OTHERS)

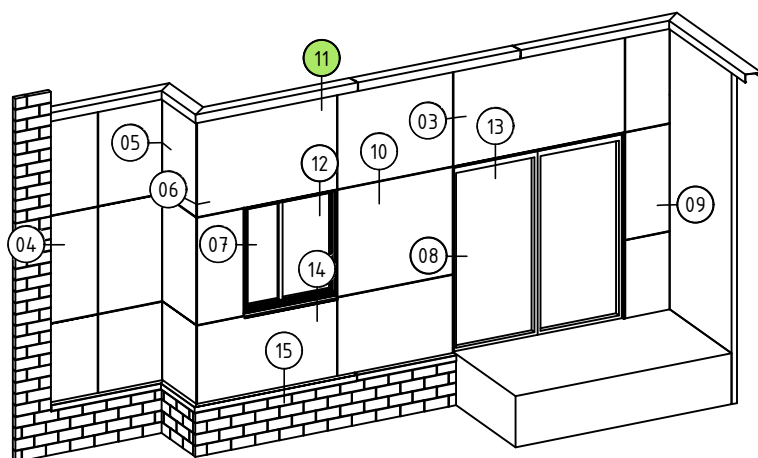
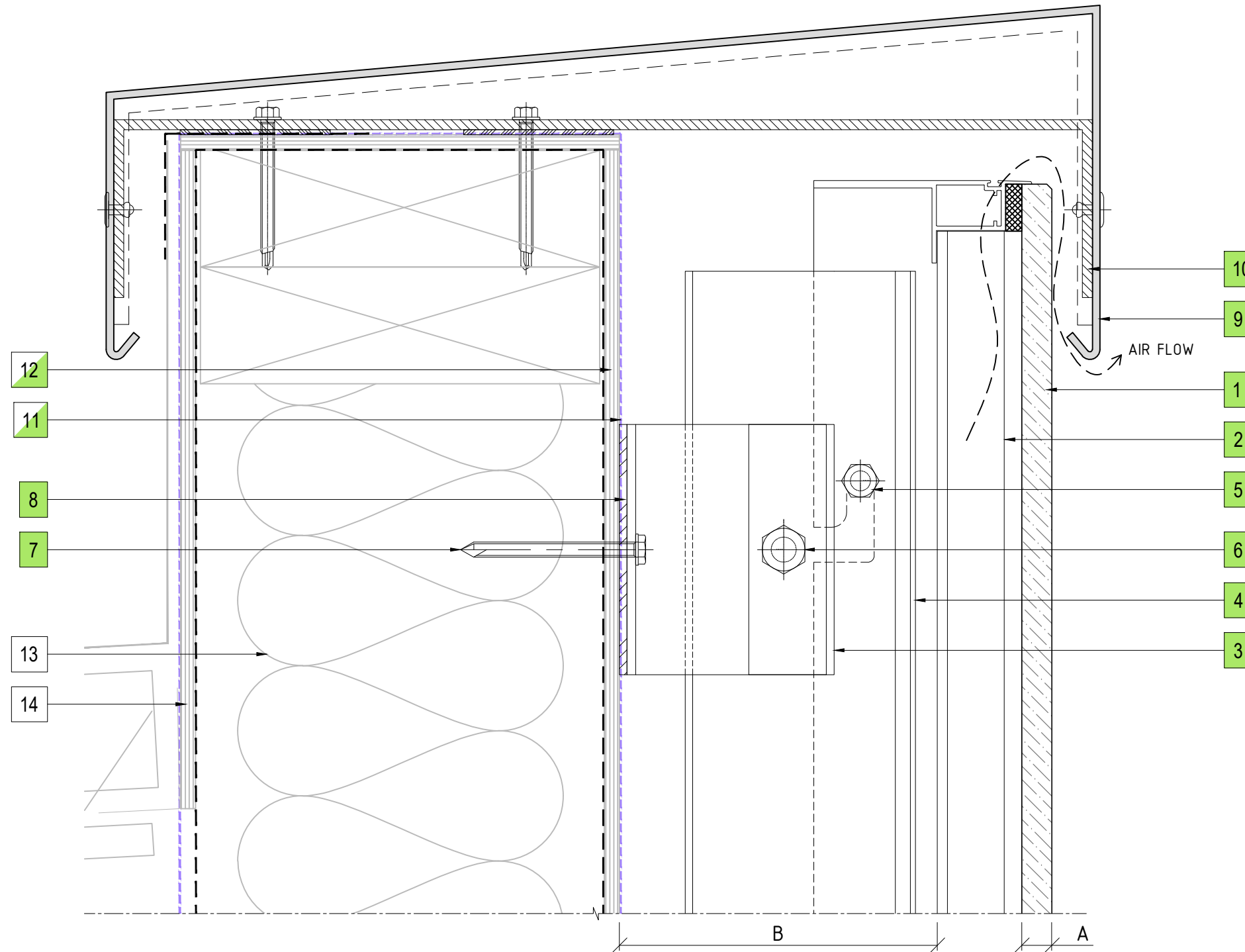

11 PARAPET FLASHING DETAIL
ENCLAD™ PORCELAIN TILES

Cladding Type :
ENCLAD™ PORCELAIN TILES

Support System :
ENCLAD™ EN05-FF - HOOK ON SECRET FIXED

Detail Description :
PARAPET FLASHING DETAIL (SECTION VIEW)

Scale @ A3 : 1:2

Rev. : NOV 2022

System # :
PORC-EN05-FF-HOE-SF6

Detail # :
11

ENCLAD™ RAINSCREEN SYSTEMS

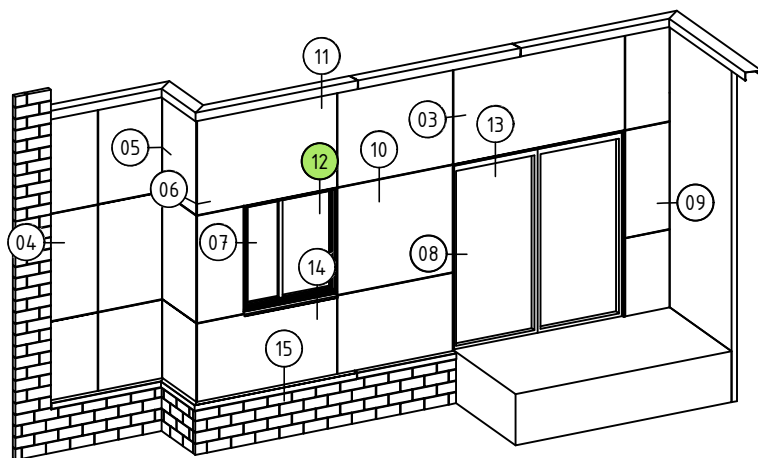
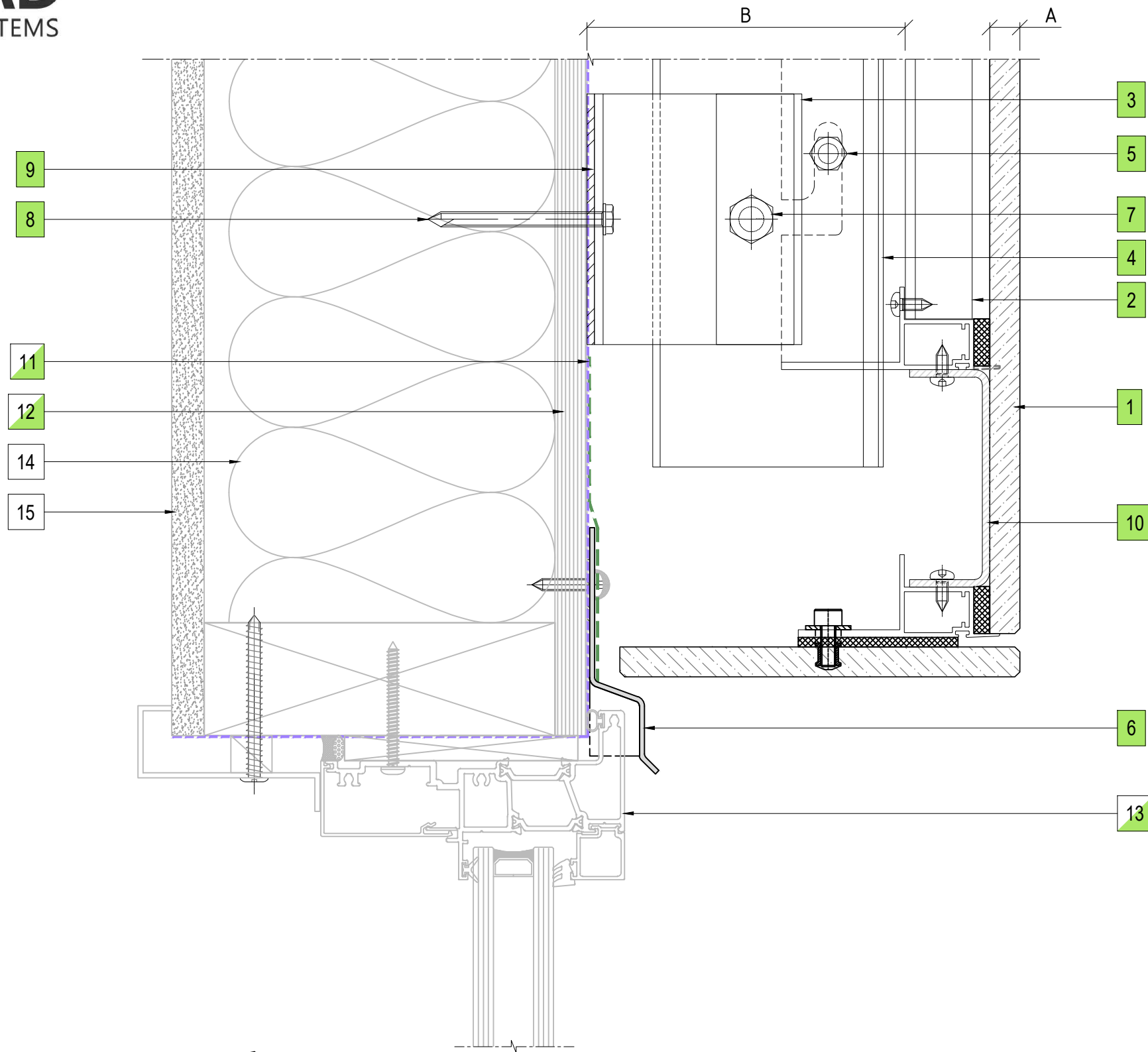

12 WINDOW HEAD DETAIL
ENCLAD™ PORCELAIN TILES

LEGEND

A	ENCLAD™ PORCELAIN TILES
B	* SYSTEM CAVITY (128mm MIN. - 152mm MAX.)
*	OTHER OPTIONS AVAILABLE (PROJECT SPECIFIC)

PARTS LIST

1	ENCLAD™ PORCELAIN TILE
2	ENCLAD EN01 ALUMINIUM SUPPORT PROFILE
3	ENCLAD EN01 ALUMINIUM STRONG BACK PROFILE
4	ENCLAD EN01 ALUMINIUM CHANNEL PROFILE
5	ENCLAD FIXING FOR HOOK (STAINLESS STEEL)
6	ENCLAD ALUMINIUM FLASHING
7	ENCLAD FIXING FOR CHANNEL PROFILE (STAINLESS STEEL)
8	ENCLAD HOST STRUCTURAL FIXING (STAINLESS STEEL)
9	ENCLAD THERMAL ISOLATION PAD
10	ENCLAD ALUMINIUM SUPPORT PROFILE
11	BUILDING WRAP / MEMBRANE (OPTION BY INSITE)
12	RIGID AIR BARRIER / SHEATHING BOARD (OPTION BY INSITE)
13	ALUMINIUM DOORS, WINDOWS & REVEALS (OPTION BY INSITE)
14	WALL INSULATION (BY OTHERS)
15	PLASTER BOARD (BY OTHERS)

Cladding Type :
ENCLAD™ PORCELAIN TILES

Support System :
ENCLAD™ EN05-FF - HOOK ON SECRET FIXED

Detail Description :
WINDOW HEAD DETAIL (SECTION VIEW)

Scale @ A3 : 1:2

Rev. : NOV 2022

System # :
PORC-EN05-FF-HOE-SF6

Detail # :
12

ENCLAD™ RAINSCREEN SYSTEMS

LEGEND

A	ENCLAD™ PORCELAIN TILES
B	* SYSTEM CAVITY (128mm MIN. - 152mm MAX.)
*	OTHER OPTIONS AVAILABLE (PROJECT SPECIFIC)

PARTS LIST

1	ENCLAD™ PORCELAIN TILE
2	ENCLAD EN01 ALUMINIUM SUPPORT PROFILE
3	ENCLAD EN01 ALUMINIUM STRONG BACK PROFILE
4	ENCLAD EN01 ALUMINIUM CHANNEL PROFILE
5	ENCLAD FIXING FOR HOOK (STAINLESS STEEL)
6	ENCLAD FIXING FOR CHANNEL PROFILE (STAINLESS STEEL)
7	ENCLAD HOST STRUCTURAL FIXING (STAINLESS STEEL)
8	ENCLAD THERMAL ISOLATION PAD
9	ENCLAD ALUMINIUM FLASHING
10	ENCLAD ALUMINIUM SUPPORT ANGLE
11	BUILDING WRAP / MEMBRANE (OPTION BY INSITE)
12	RIGID AIR BARRIER / SHEATHING BOARD (OPTION BY INSITE)
13	ALUMINIUM DOORS, WINDOWS & REVEALS (OPTION BY INSITE)
14	WALL INSULATION (BY OTHERS)
15	PLASTER BOARD (BY OTHERS)

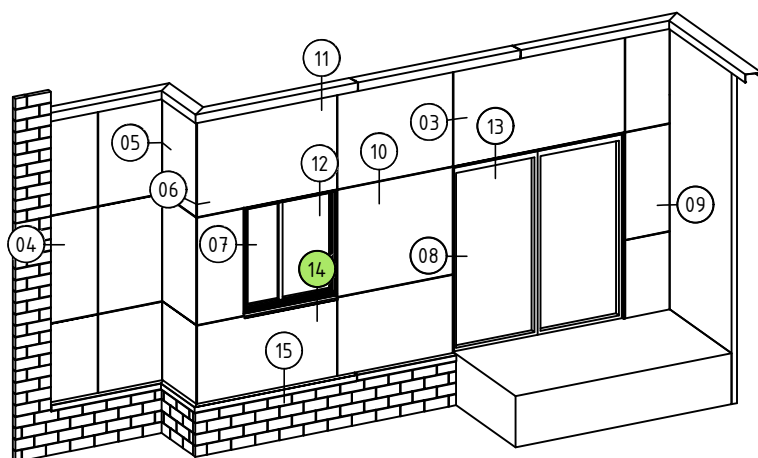
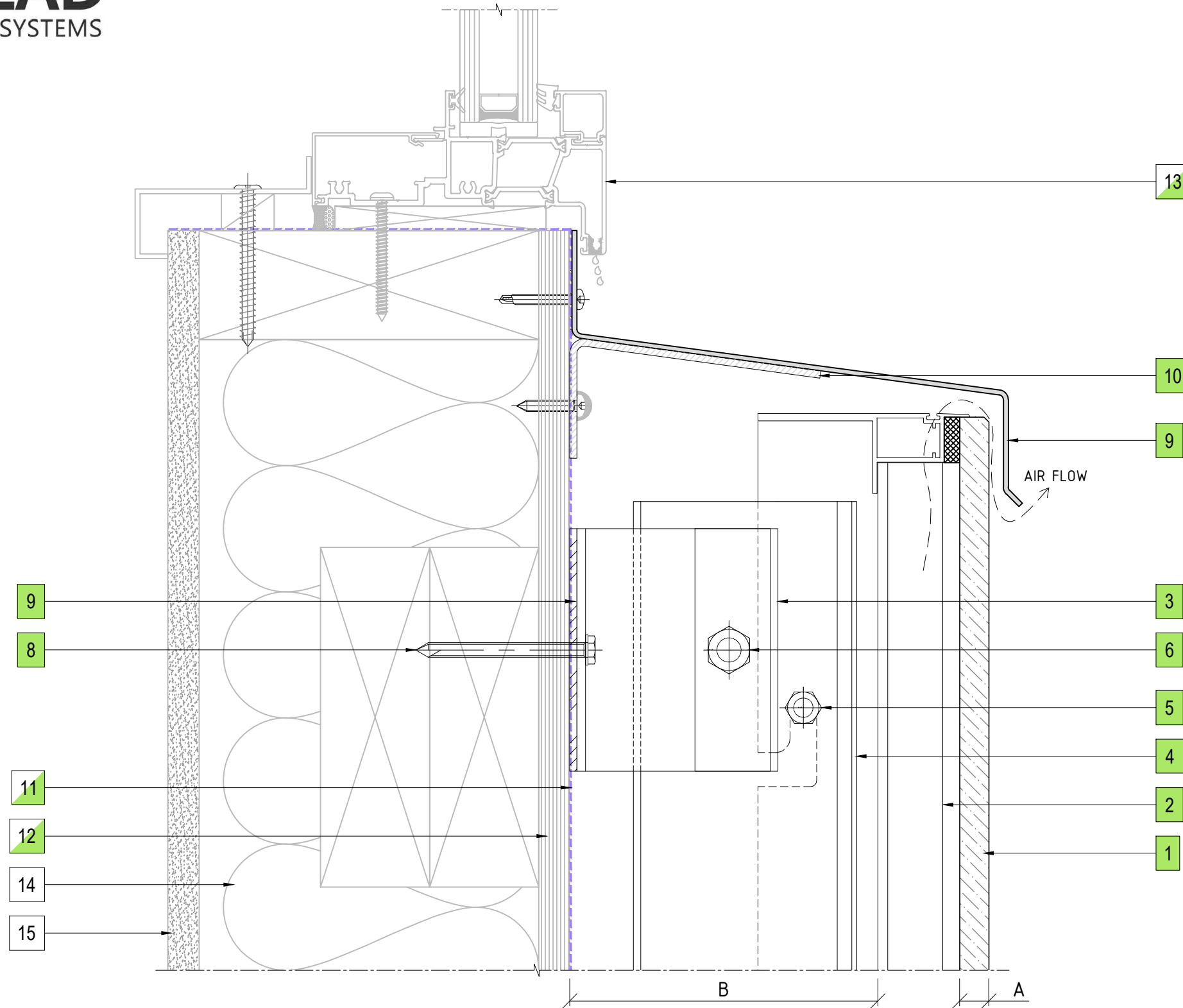

14 WINDOW SILL DETAIL
ENCLAD™ PORCELAIN TILES

Cladding Type :
ENCLAD™ PORCELAIN TILES

Support System :
ENCLAD™ EN05-FF - HOOK ON SECRET FIXED

Detail Description :
WINDOW SILL DETAIL (SECTION VIEW)

Scale @ A3 : 1:2

Rev. : NOV 2022

System # :
PORC-EN05-FF-HOE-SF6

Detail # :
14

ENCLAD™ RAINSCREEN SYSTEMS

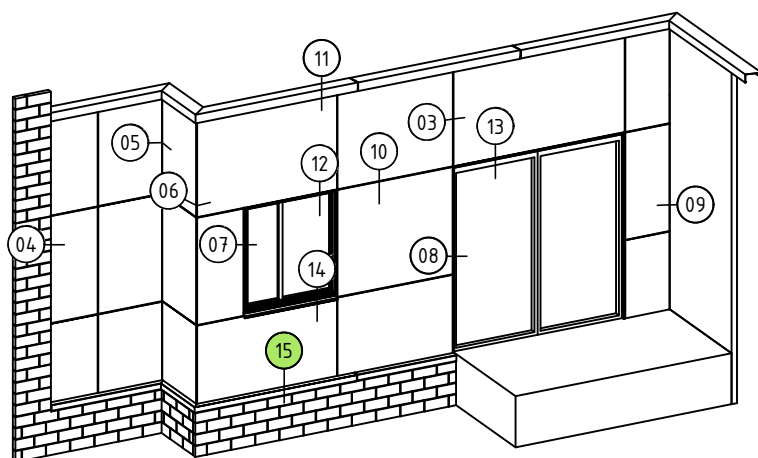
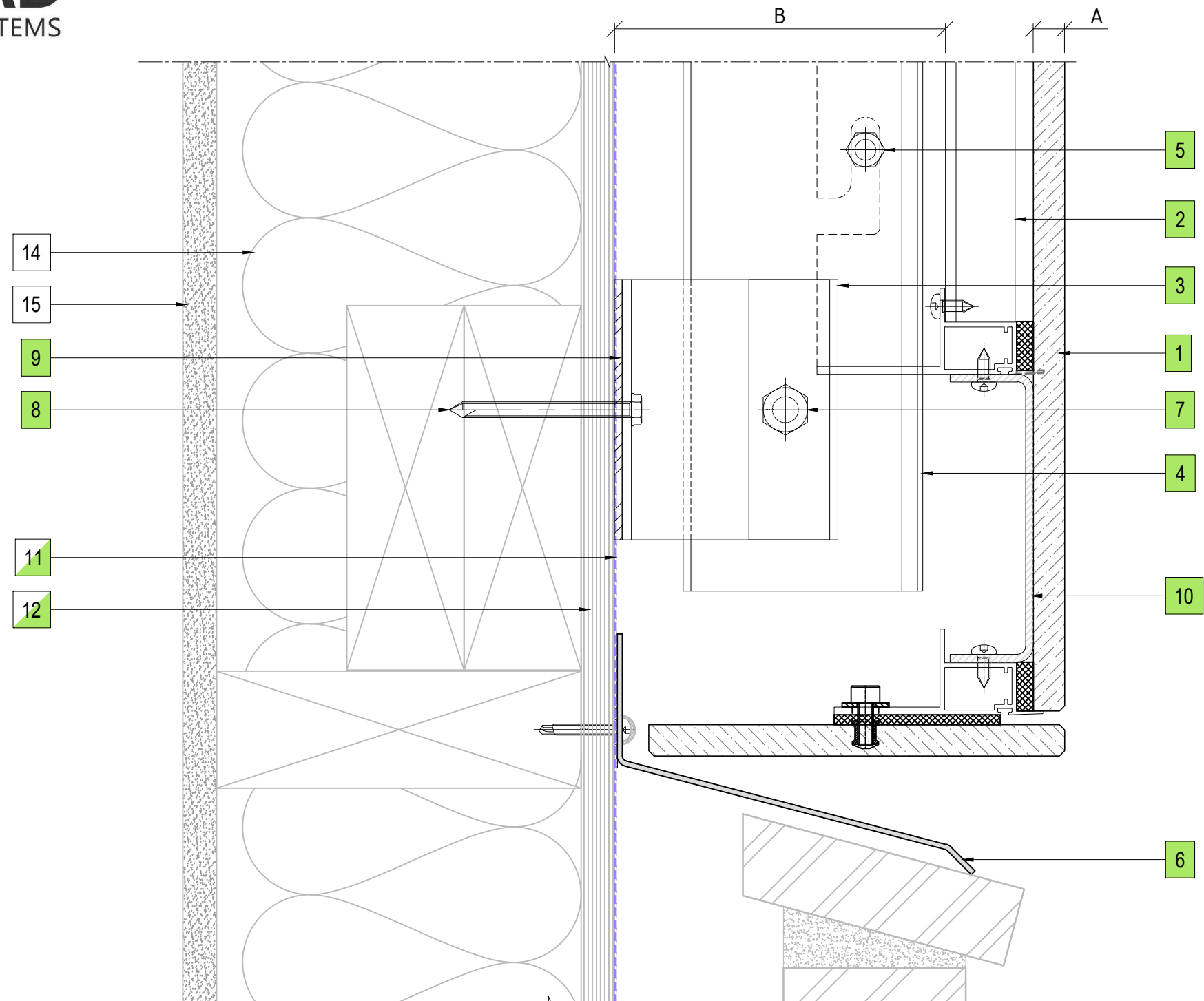

15 BRICKWALL AT BASE DRIP DETAIL
ENCLAD™ PORCELAIN TILES

LEGEND

A	ENCLAD™ PORCELAIN TILES
B	* SYSTEM CAVITY (128mm MIN. - 152mm MAX.)
*	OTHER OPTIONS AVAILABLE (PROJECT SPECIFIC)

PARTS LIST

1	ENCLAD™ PORCELAIN TILE
2	ENCLAD EN01 ALUMINIUM SUPPORT PROFILE
3	ENCLAD EN01 ALUMINIUM STRONG BACK PROFILE
4	ENCLAD EN01 ALUMINIUM CHANNEL PROFILE
5	ENCLAD FIXING FOR HOOK (STAINLESS STEEL)
6	ENCLAD ALUMINIUM FLASHING
7	ENCLAD FIXING FOR CHANNEL PROFILE (STAINLESS STEEL)
8	ENCLAD HOST STRUCTURAL FIXING (STAINLESS STEEL)
9	ENCLAD THERMAL ISOLATION PAD
10	ENCLAD ALUMINIUM SUPPORT PROFILE
11	BUILDING WRAP / MEMBRANE (OPTION BY INSITE)
12	RIGID AIR BARRIER / SHEATHING BOARD (OPTION BY INSITE)
14	WALL INSULATION (BY OTHERS)
15	PLASTER BOARD (BY OTHERS)

Cladding Type :
ENCLAD™ PORCELAIN TILES

Support System :
ENCLAD™ EN05-FF - HOOK ON SECRET FIXED

Detail Description :
BRICKWALL AT BASE DRIP DETAIL (SECTION VIEW)

Scale @ A3 : 1:2

Rev. : NOV 2022

System # :
PORC-EN05-FF-HOE-SF6

Detail # :
15

ENCLAD™ RAINSCREEN SYSTEMS

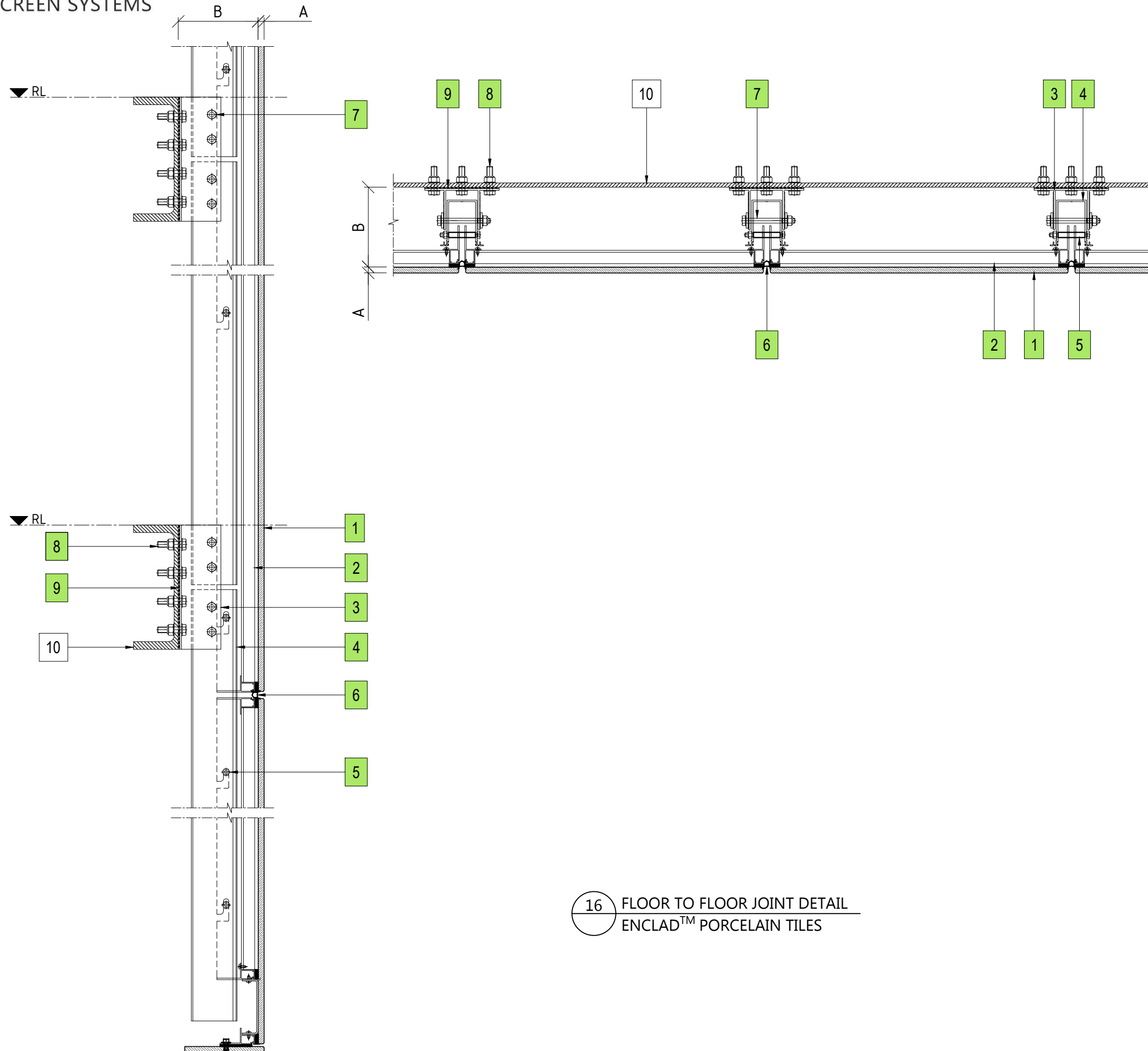

16 FLOOR TO FLOOR JOINT DETAIL
ENCLAD™ PORCELAIN TILES

PART OF THE THERMOSASH GROUP COMPANIES :



COPYRIGHT : THESE DESIGNS, DETAILS AND/OR SPECIFICATIONS AND THE COPYRIGHT THEREIN, REMAIN THE PROPERTY OF INSITE FACADES LTD.

DISCLAIMER : THESE DETAILS ARE PROVIDED FOR INDICATIVE PURPOSES ONLY. CONSTRUCTION/SYSTEM DETAILS CAN VARY DEPENDING ON PROJECT SPECIFIC SPECIFICATION AND ENGINEERING REQUIREMENTS. THE DESIGNER IS RESPONSIBLE FOR ENSURING DETAILS SATISFY ALL NEW ZEALAND BUILDING CODE CLAUSES. THE DESIGNER IS RESPONSIBLE FOR ENSURING BUILDING WRAPS, FIRESTOPS AND INSULATION/SPECIFICATION COMPLY WITH MANUFACTURERS RECOMMENDATIONS AND NZBC REGULATIONS. REFER TO INSITE WEBSITE FOR FULL TERMS AND CONDITIONS.

LEGEND

A	ENCLAD™ PORCELAIN TILES
B	* SYSTEM CAVITY (128mm MIN. - 152mm MAX.)
*	OTHER OPTIONS AVAILABLE (PROJECT SPECIFIC)

PARTS LIST

1	ENCLAD™ PORCELAIN TILE
2	ENCLAD EN01 ALUMINIUM SUPPORT PROFILE
3	ENCLAD EN01 ALUMINIUM STRONG BACK PROFILE
4	ENCLAD EN01 ALUMINIUM CHANNEL PROFILE
5	ENCLAD FIXING FOR HOOK (STAINLESS STEEL)
6	ENCLAD GASKET
7	ENCLAD FIXING FOR CHANNEL PROFILE (STAINLESS STEEL)
8	ENCLAD HOST STRUCTURAL FIXING (STAINLESS STEEL)
9	ENCLAD THERMAL ISOLATION PAD
10	PFC (BY OTHERS)

Cladding Type :
ENCLAD™ PORCELAIN TILES

Support System :
ENCLAD™ EN05-FF - HOOK ON SECRET FIXED

Detail Description :
FLOOR TO FLOOR JOINT DETAIL
(SECTION VIEW)

Scale @ A3 : 1:8
Rev. : NOV 2022

System # :
PORC-EN05-FF-HOE-SF6
Detail # :
16

ENCLAD™ RAINSCREEN SYSTEMS



101 STATION ROAD, PENROSE,
AUCKLAND 1061
NEW ZEALAND

P: +64 9 307 1529
www.insitefacades.co.nz