

ENCLADTM SOLID SHEET *

ENCLADTM EN04 SUPPORT SYSTEM

HOOK ON SECRET FIXED

DRAWING REGISTER

| PAGE | DETAIL DESCRIPTION | DETAIL # | REV. |
|-------|--|----------|--------|
| 00/15 | COVER PAGE | 00 | NOV 22 |
| 01/15 | CAVITY SET OUT | 01 | NOV 22 |
| 02/15 | SCHEMATIC | 02 | NOV 22 |
| 03/15 | VERTICAL PANEL JOINT DETAIL (PLAN VIEW) | 03 | NOV 22 |
| 04/15 | BRICKWALL ABUTMENT DETAIL (PLAN VIEW) | 04 | NOV 22 |
| 05/15 | INTERNAL CORNER PANEL DETAIL (PLAN VIEW) | 05 | NOV 22 |
| 06/15 | EXTERNAL CORNER PANEL DETAIL (PLAN VIEW) | 06 | NOV 22 |
| 07/15 | WINDOW JAMB DETAIL (PLAN VIEW) | 07 | NOV 22 |
| 08/15 | DOOR JAMB DETAIL (PLAN VIEW) | 08 | NOV 22 |
| 09/15 | CONCRETE WALL ABUTMENT DETAIL (PLAN VIEW) | 09 | NOV 22 |
| 10/15 | HORIZONTAL PANEL JOINT DETAIL (SECTION VIEW) | 10 | NOV 22 |
| 11/15 | PARAPET FLASHING DETAIL (SECTION VIEW) | 11 | NOV 22 |
| 12/15 | WINDOW HEAD DETAIL (SECTION VIEW) | 12 | NOV 22 |
| 13/15 | DOOR HEAD DETAIL (SECTION VIEW) | 13 | NOV 22 |
| 14/15 | WINDOW SILL DETAIL (SECTION VIEW) | 14 | NOV 22 |
| 15/15 | BRICKWALL AT BASE DRIP DETAIL (SECTION VIEW) | 15 | NOV 22 |

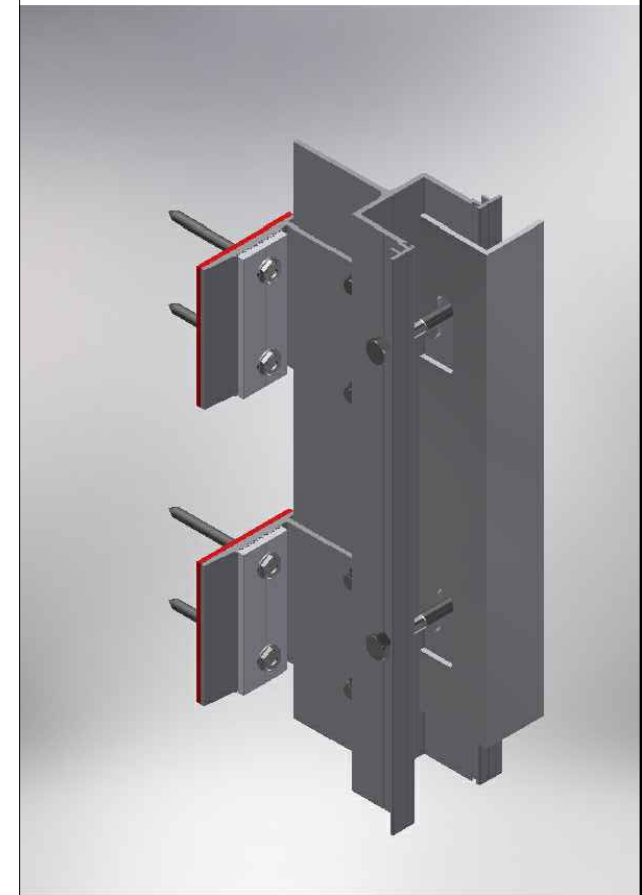

* SOLID SHEET OPTIONS

- SOLID ALUMINIUM
- ALUCOLUX®
- PERFORATED ALUMINIUM
- STAINLESS STEEL
- COPPER
- SOLID ZINC

Cladding Type :

ENCLADTM SOLID SHEET *

Support System :

ENCLADTM EN04 - HOOK ON SECRET FIXED

Detail Description :

COVER PAGE

Scale @ A3 :

Rev. : NOV 2022

System # :

SS-EN04-HOP-SF2

Detail # :

00

ENCLADTM RAINSCREEN SYSTEMS

EN04 - ADJUSTABLE SYSTEM CAVITY

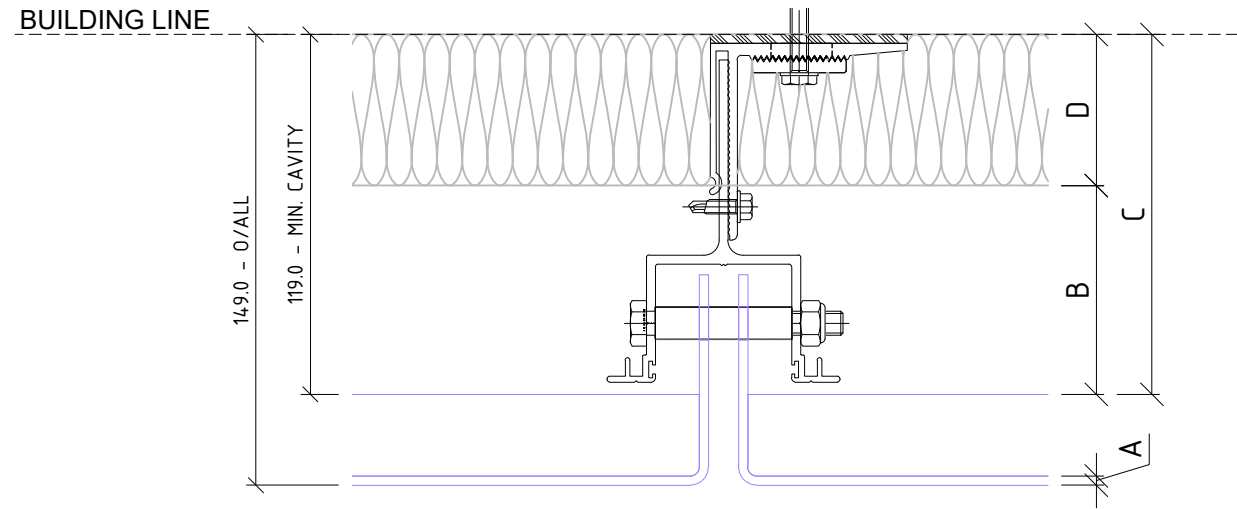

50mm THICK INSULATION
IN CAVITY ZONE

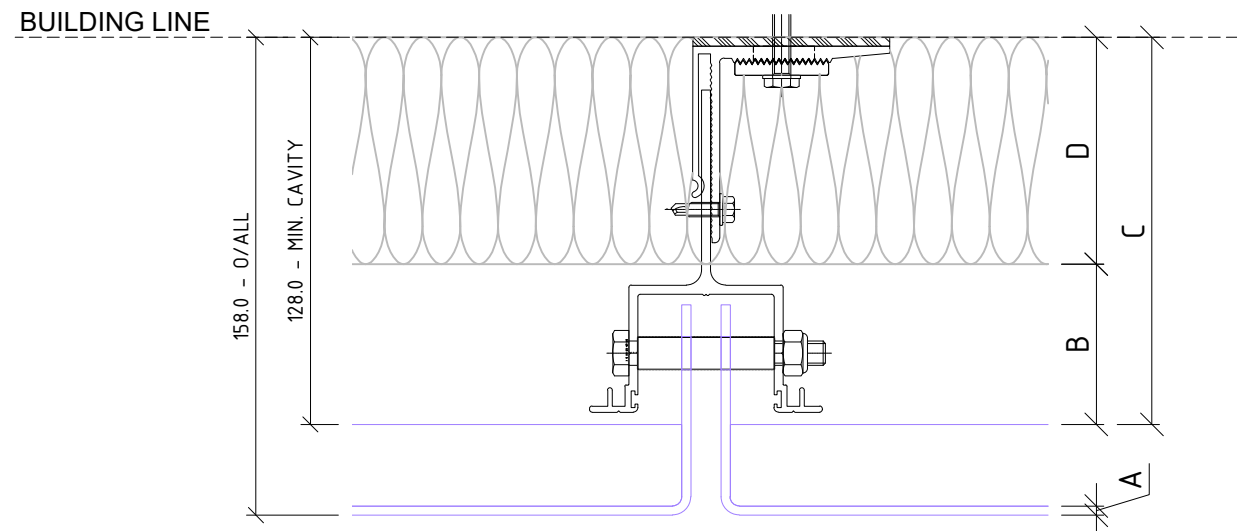

75mm THICK INSULATION
IN CAVITY ZONE

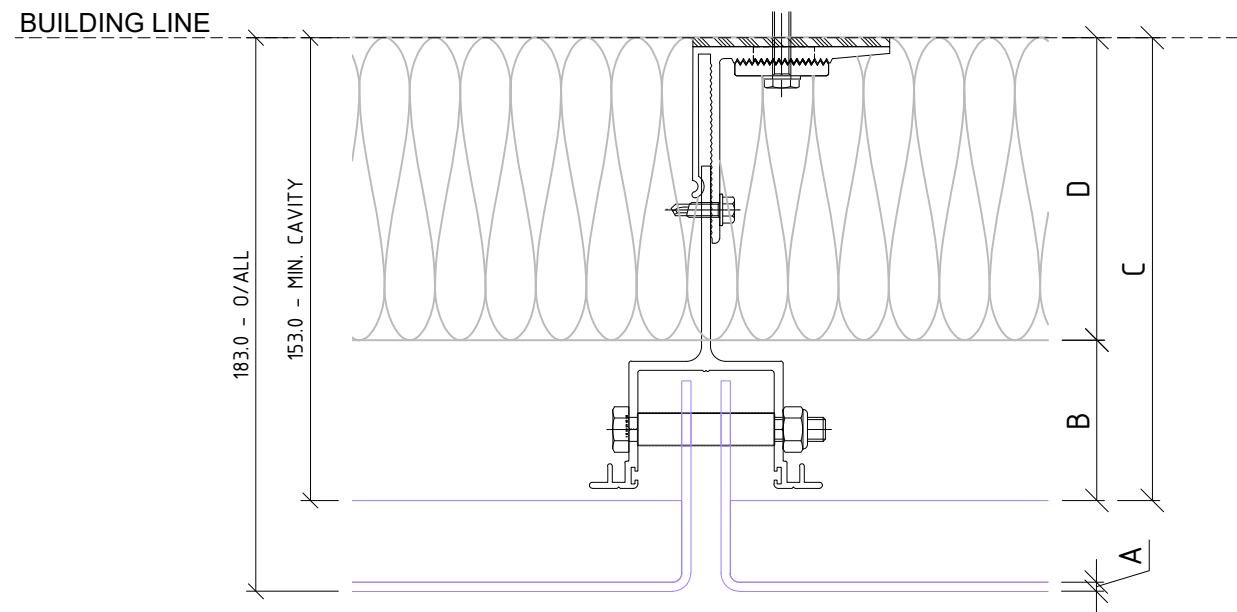

100mm THICK INSULATION
IN CAVITY ZONE

01 CAVITY SET OUT
ENCLAD™ SOLID SHEET *

ADJUSTABLE SYSTEMS ACCOMMODATE BUILDING TOLERANCE AND INCORPORATION OF INSULATION FOR H1 REQUIREMENTS - STANDARD SYSTEM CAVITY SHOWN - BESPOKE OPTIONS AVAILABLE FOR PROJECT SPECIFIC REQUIREMENTS

PART OF THE THERMOSASH GROUP COMPANIES :



COPYRIGHT : THESE DESIGNS, DETAILS AND/OR SPECIFICATIONS AND THE COPYRIGHT THEREIN, REMAIN THE PROPERTY OF INSITE FACADES LTD.

DISCLAIMER : THESE DETAILS ARE PROVIDED FOR INDICATIVE PURPOSES ONLY. CONSTRUCTION/SYSTEM DETAILS CAN VARY DEPENDING ON PROJECT SPECIFIC SPECIFICATION AND ENGINEERING REQUIREMENTS. THE DESIGNER IS RESPONSIBLE FOR ENSURING DETAILS SATISFY ALL NEW ZEALAND BUILDING CODE CLAUSES. THE DESIGNER IS RESPONSIBLE FOR ENSURING BUILDING WRAPS, FIRESTOPS AND INSULATION/SPECIFICATION COMPLY WITH MANUFACTURERS RECOMMENDATIONS AND NZBC REGULATIONS. REFER TO INSITE WEBSITE FOR FULL TERMS AND CONDITIONS.

LEGEND

| | |
|----|---|
| A | ENCLAD™ SOLID SHEET * |
| B | 53mm - 69mm NOMINAL VENTILATION ZONE (AIR GAP) |
| C | ** 119mm SYSTEM CAVITY TO ACCOMMODATE 50mm THICK INSULATION |
| D | ** 50mm INSULATION (OPTION BY INSITE) FIRE STOP (OPTION BY INSITE) |
| ** | OTHER OPTIONS AVAILABLE (PROJECT SPECIFIC) 128mm SYSTEM CAVITY FOR 75mm THICK INSULATION 153mm SYSTEM CAVITY FOR 100mm THICK INSULATION |

*** SOLID SHEET OPTIONS**

| | |
|---|----------------------|
| • | SOLID ALUMINIUM |
| • | ALUCOLUX® |
| • | PERFORATED ALUMINIUM |
| • | STAINLESS STEEL |
| • | COPPER |
| • | SOLID ZINC |

Cladding Type :

ENCLAD™ SOLID SHEET *

Support System :

ENCLAD™ EN04 - HOOK ON SECRET FIXED

Detail Description :

CAVITY SETOUT (PLAN VIEW)

Scale @ A3 : 1:2.5

Rev. : NOV 2022

System # :

SS-EN04-HOP-SF2

Detail # :

01

ENCLAD™ RAINSCREEN SYSTEMS



101 STATION ROAD, PENROSE,
AUCKLAND 1061
NEW ZEALAND

P: +64 9 307 1529
www.insitefacades.co.nz

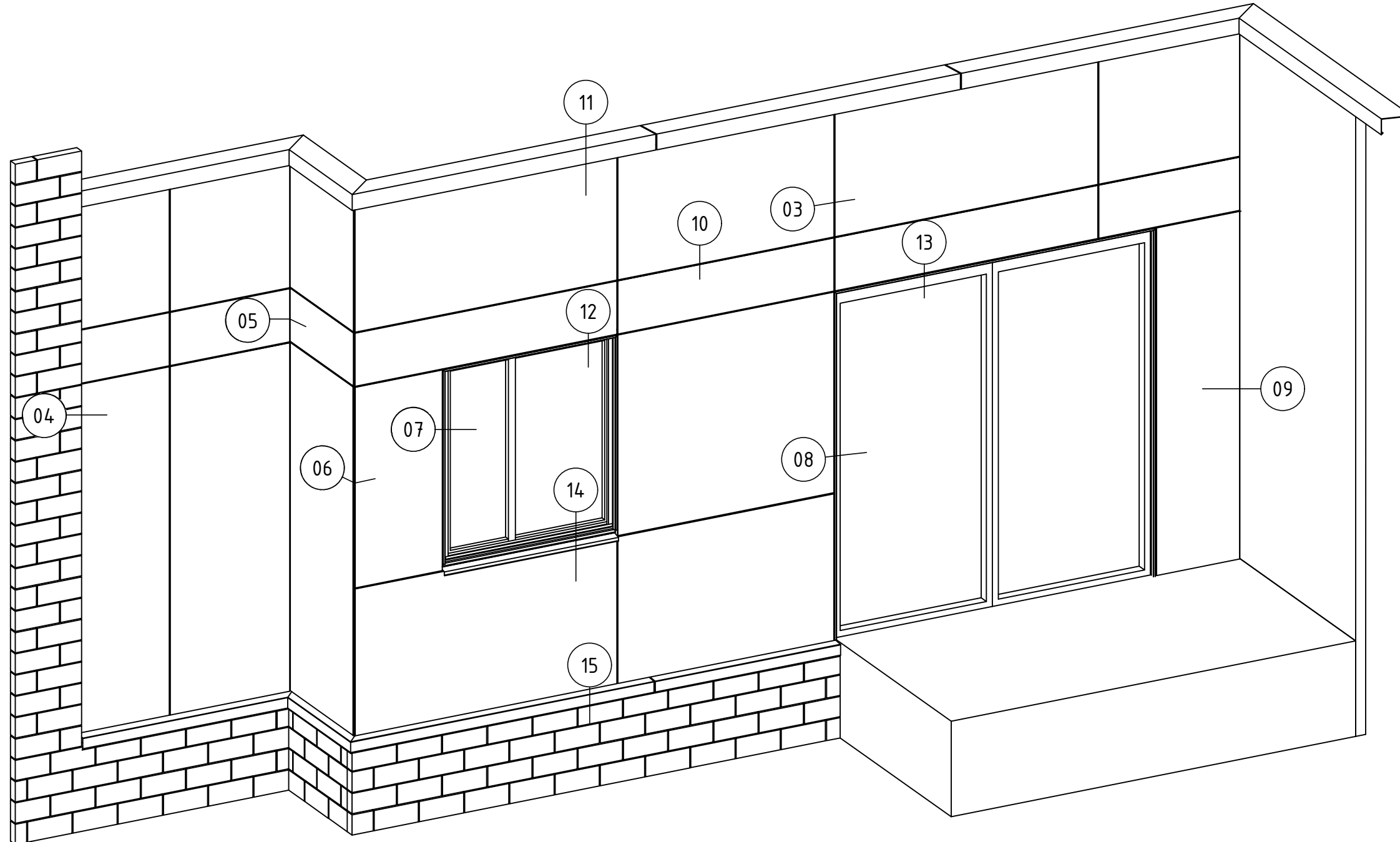

02 SCHEMATIC
ENCLAD™ SOLID SHEET *

*** SOLID SHEET OPTIONS**

- SOLID ALUMINIUM
- ALUCOLUX®
- PERFORATED ALUMINIUM
- STAINLESS STEEL
- COPPER
- SOLID ZINC

Cladding Type :
ENCLAD™ SOLID SHEET *

Support System :
ENCLAD™ EN04 - HOOK ON SECRET FIXED

Detail Description :
SCHEMATIC

Scale @ A3 : 1:5

Rev. : NOV 2022

System # :
SS-EN04-HOP-SF2

Detail # :
02

ENCLAD™ RAINSCREEN SYSTEMS

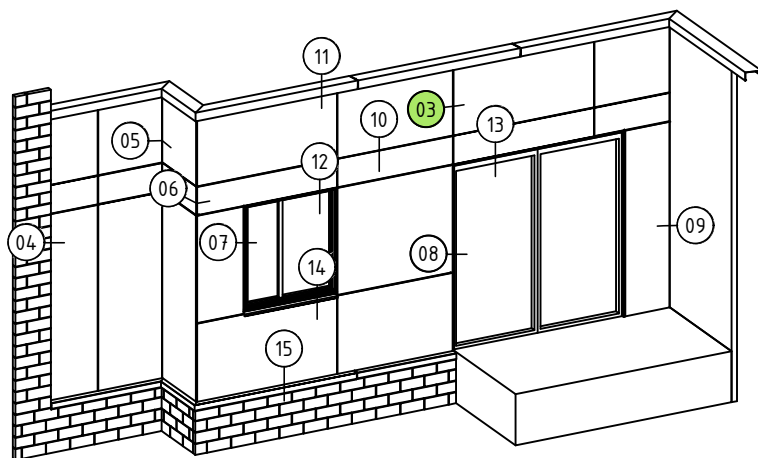
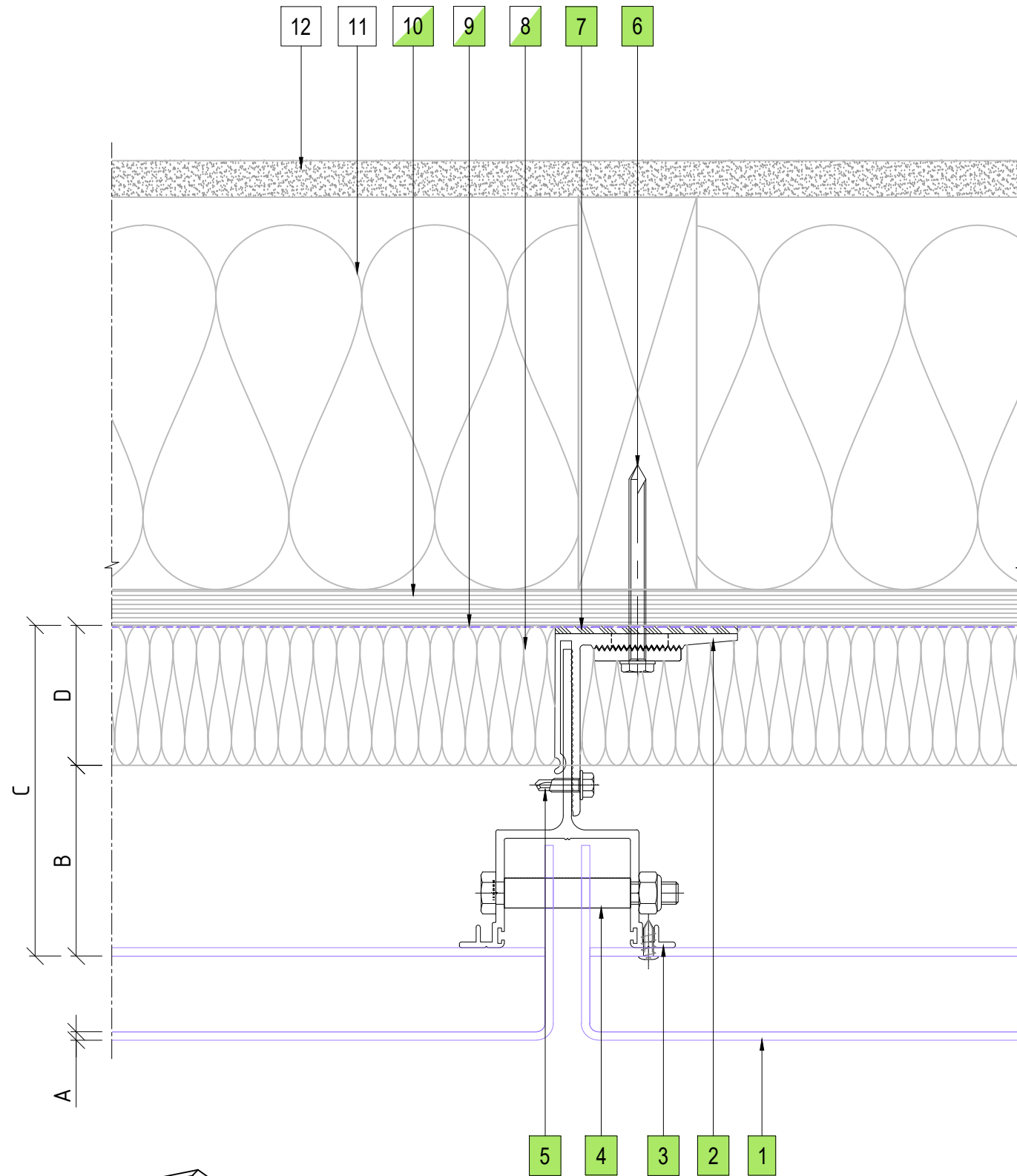

03 VERTICAL PANEL JOINT DETAIL
ENCLAD™ SOLID SHEET *

LEGEND

| | |
|----|---|
| A | ENCLAD™ SOLID SHEET * |
| B | 53mm - 69mm NOMINAL VENTILATION ZONE (AIR GAP) |
| C | ** 119mm SYSTEM CAVITY TO ACCOMMODATE 50mm THICK INSULATION |
| D | ** 50mm INSULATION (OPTION BY INSITE) FIRE STOP (OPTION BY INSITE) |
| ** | OTHER OPTIONS AVAILABLE (PROJECT SPECIFIC) 128mm SYSTEM CAVITY FOR 75mm THICK INSULATION 153mm SYSTEM CAVITY FOR 100mm THICK INSULATION |

PARTS LIST

| | |
|----|--|
| 1 | ENCLAD™ FOLDED ALUMINIUM PANEL |
| 2 | ENCLAD EN01 ALUMINIUM HELPING HAND BRACKET |
| 3 | ENCLAD EN01 ALUMINIUM CHANNEL PROFILE |
| 4 | ENCLAD FIXING FOR HOOK (STAINLESS STEEL) |
| 5 | ENCLAD BRACKET TO RAIL FIXING (STAINLESS STEEL) |
| 6 | ENCLAD HOST STRUCTURAL FIXING (STAINLESS STEEL) |
| 7 | ENCLAD THERMAL ISOLATION PAD |
| 8 | CAVITY INSULATION (OPTION BY INSITE) |
| 9 | BUILDING WRAP / MEMBRANE (OPTION BY INSITE) |
| 10 | RIGID AIR BARRIER / SHEATHING BOARD (OPTION BY INSITE) |
| 11 | WALL INSULATION (BY OTHERS) |
| 12 | PLASTER BOARD (BY OTHERS) |

*** SOLID SHEET OPTIONS**

| | |
|---|----------------------|
| • | SOLID ALUMINIUM |
| • | ALUCOLUX® |
| • | PERFORATED ALUMINIUM |
| • | STAINLESS STEEL |
| • | COPPER |
| • | SOLID ZINC |

Cladding Type :

ENCLAD™ SOLID SHEET *

Support System :

ENCLAD™ EN04 - HOOK ON SECRET FIXED

Detail Description :

VERTICAL PANEL JOINT DETAIL(PLAN VIEW)

Scale @ A3 : 1:2

Rev. : NOV 2022

System # :

SS-EN04-HOP-SF2

Detail # :

03

ENCLAD™ RAINSCREEN SYSTEMS

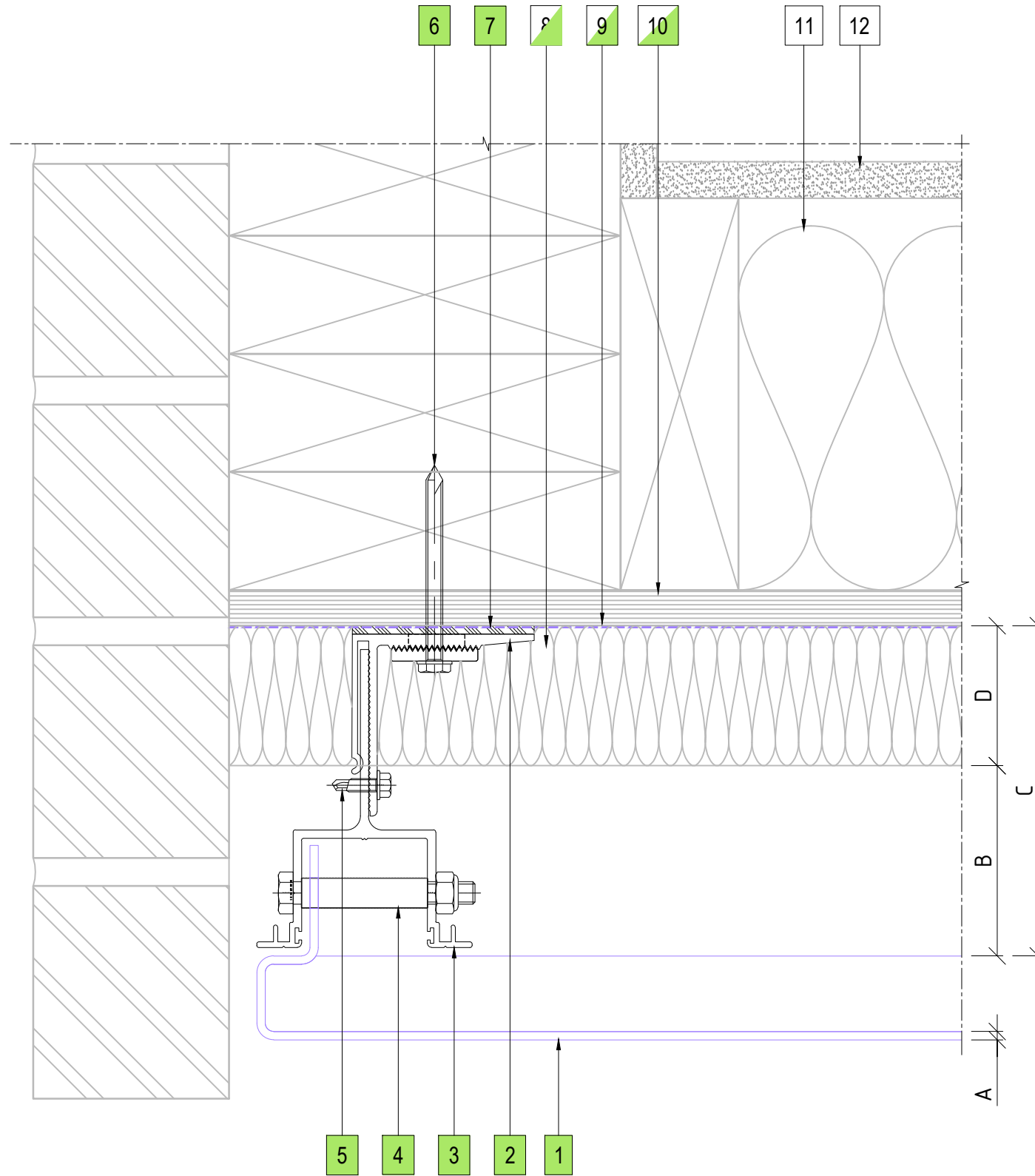

5 4 3 2 1

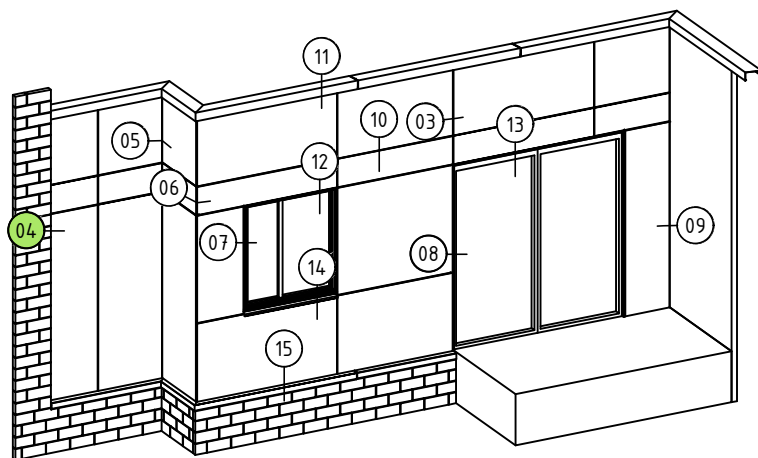

04 BRICKWALL ABUTMENT DETAIL
ENCLAD™ SOLID SHEET *

PART OF THE THERMOSASH GROUP COMPANIES :



COPYRIGHT : THESE DESIGNS, DETAILS AND/OR SPECIFICATIONS AND THE COPYRIGHT THEREIN, REMAIN THE PROPERTY OF INSITE FACADES LTD.

DISCLAIMER : THESE DETAILS ARE PROVIDED FOR INDICATIVE PURPOSES ONLY. CONSTRUCTION/SYSTEM DETAILS CAN VARY DEPENDING ON PROJECT SPECIFIC SPECIFICATION AND ENGINEERING REQUIREMENTS. THE DESIGNER IS RESPONSIBLE FOR ENSURING DETAILS SATISFY ALL NEW ZEALAND BUILDING CODE CLAUSES. THE DESIGNER IS RESPONSIBLE FOR ENSURING BUILDING WRAPS, FIRESTOPS AND INSULATION/SPECIFICATION COMPLY WITH MANUFACTURERS RECOMMENDATIONS AND NZBC REGULATIONS. REFER TO INSITE WEBSITE FOR FULL TERMS AND CONDITIONS.

LEGEND

| | |
|----|---|
| A | ENCLAD™ SOLID SHEET * |
| B | 53mm - 69mm NOMINAL VENTILATION ZONE (AIR GAP) |
| C | ** 119mm SYSTEM CAVITY TO ACCOMMODATE 50mm THICK INSULATION |
| D | ** 50mm INSULATION (OPTION BY INSITE) FIRE STOP (OPTION BY INSITE) |
| ** | OTHER OPTIONS AVAILABLE (PROJECT SPECIFIC) 128mm SYSTEM CAVITY FOR 75mm THICK INSULATION 153mm SYSTEM CAVITY FOR 100mm THICK INSULATION |

PARTS LIST

| | |
|----|--|
| 1 | ENCLAD™ FOLDED ALUMINIUM PANEL |
| 2 | ENCLAD EN01 ALUMINIUM HELPING HAND BRACKET |
| 3 | ENCLAD EN01 ALUMINIUM CHANNEL PROFILE |
| 4 | ENCLAD FIXING FOR HOOK (STAINLESS STEEL) |
| 5 | ENCLAD BRACKET TO RAIL FIXING (STAINLESS STEEL) |
| 6 | ENCLAD HOST STRUCTURAL FIXING (STAINLESS STEEL) |
| 7 | ENCLAD THERMAL ISOLATION PAD |
| 8 | CAVITY INSULATION (OPTION BY INSITE) |
| 9 | BUILDING WRAP / MEMBRANE (OPTION BY INSITE) |
| 10 | RIGID AIR BARRIER / SHEATHING BOARD (OPTION BY INSITE) |
| 11 | WALL INSULATION (BY OTHERS) |
| 12 | PLASTER BOARD (BY OTHERS) |

*** SOLID SHEET OPTIONS**

| | |
|---|----------------------|
| • | SOLID ALUMINIUM |
| • | ALUCOLUX® |
| • | PERFORATED ALUMINIUM |
| • | STAINLESS STEEL |
| • | COPPER |
| • | SOLID ZINC |

Cladding Type :

ENCLAD™ SOLID SHEET *

Support System :

ENCLAD™ EN04 - HOOK ON SECRET FIXED

Detail Description :

BRICKWALL ABUTMENT DETAIL(PLAN VIEW)

Scale @ A3 : 1:2

Rev. : NOV 2022

System # :

SS-EN04-HOP-SF2

Detail # :

04

ENCLAD™ RAINSCREEN SYSTEMS



101 STATION ROAD, PENROSE,
AUCKLAND 1061
NEW ZEALAND

P: +64 9 307 1529
www.insitefacades.co.nz

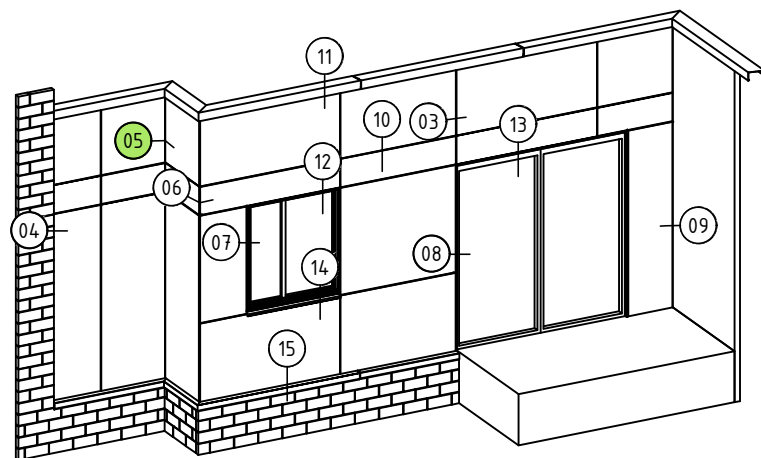
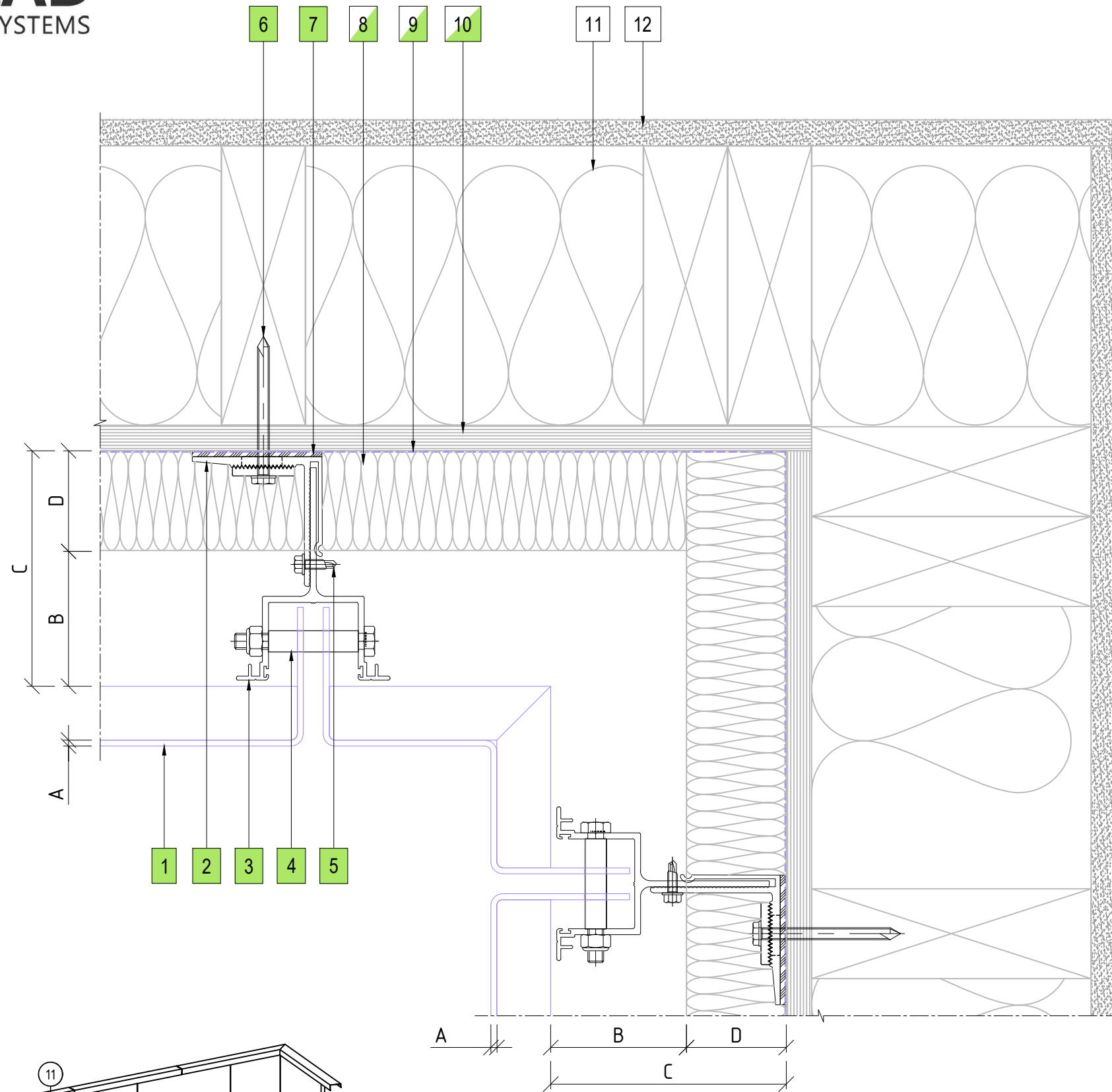

05 INTERNAL CORNER PANEL DETAIL
ENCLAD™ SOLID SHEET *

LEGEND

| | |
|----|---|
| A | ENCLAD™ SOLID SHEET * |
| B | 53mm - 69mm NOMINAL VENTILATION ZONE (AIR GAP) |
| C | ** 119mm SYSTEM CAVITY TO ACCOMMODATE 50mm THICK INSULATION |
| D | ** 50mm INSULATION (OPTION BY INSITE) FIRE STOP (OPTION BY INSITE) |
| ** | OTHER OPTIONS AVAILABLE (PROJECT SPECIFIC) 128mm SYSTEM CAVITY FOR 75mm THICK INSULATION 153mm SYSTEM CAVITY FOR 100mm THICK INSULATION |

PARTS LIST

| | |
|----|--|
| 1 | ENCLAD™ FOLDED ALUMINIUM PANEL |
| 2 | ENCLAD EN01 ALUMINIUM HELPING HAND BRACKET |
| 3 | ENCLAD EN01 ALUMINIUM CHANNEL PROFILE |
| 4 | ENCLAD FIXING FOR HOOK (STAINLESS STEEL) |
| 5 | ENCLAD BRACKET TO RAIL FIXING (STAINLESS STEEL) |
| 6 | ENCLAD HOST STRUCTURAL FIXING (STAINLESS STEEL) |
| 7 | ENCLAD THERMAL ISOLATION PAD |
| 8 | CAVITY INSULATION (OPTION BY INSITE) |
| 9 | BUILDING WRAP / MEMBRANE (OPTION BY INSITE) |
| 10 | RIGID AIR BARRIER / SHEATHING BOARD (OPTION BY INSITE) |
| 11 | WALL INSULATION (BY OTHERS) |
| 12 | PLASTER BOARD (BY OTHERS) |

*** SOLID SHEET OPTIONS**

| | |
|---|----------------------|
| • | SOLID ALUMINIUM |
| • | ALUCOLUX® |
| • | PERFORATED ALUMINIUM |
| • | STAINLESS STEEL |
| • | COPPER |
| • | SOLID ZINC |

Cladding Type :

ENCLAD™ SOLID SHEET *

Support System :

ENCLAD™ EN04 - HOOK ON SECRET FIXED

Detail Description :

INTERNAL CORNER PANEL DETAIL(PLAN VIEW)

Scale @ A3 : 1:2.5

Rev. : NOV 2022

System # :

SS-EN04-HOP-SF2

Detail # :

05

ENCLAD™ RAINSCREEN SYSTEMS

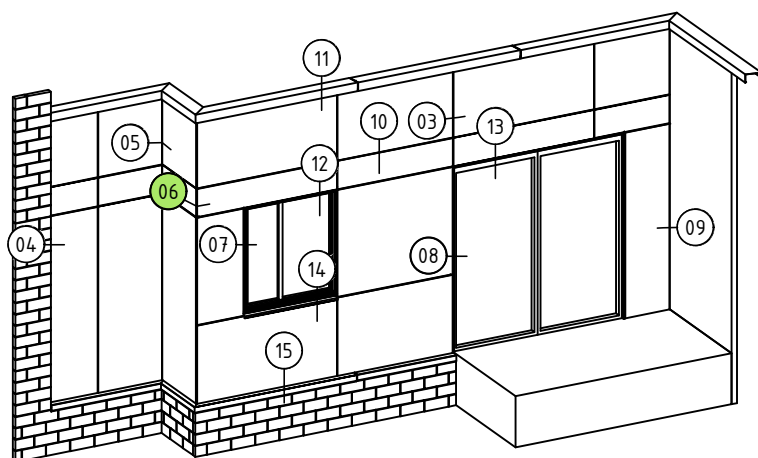
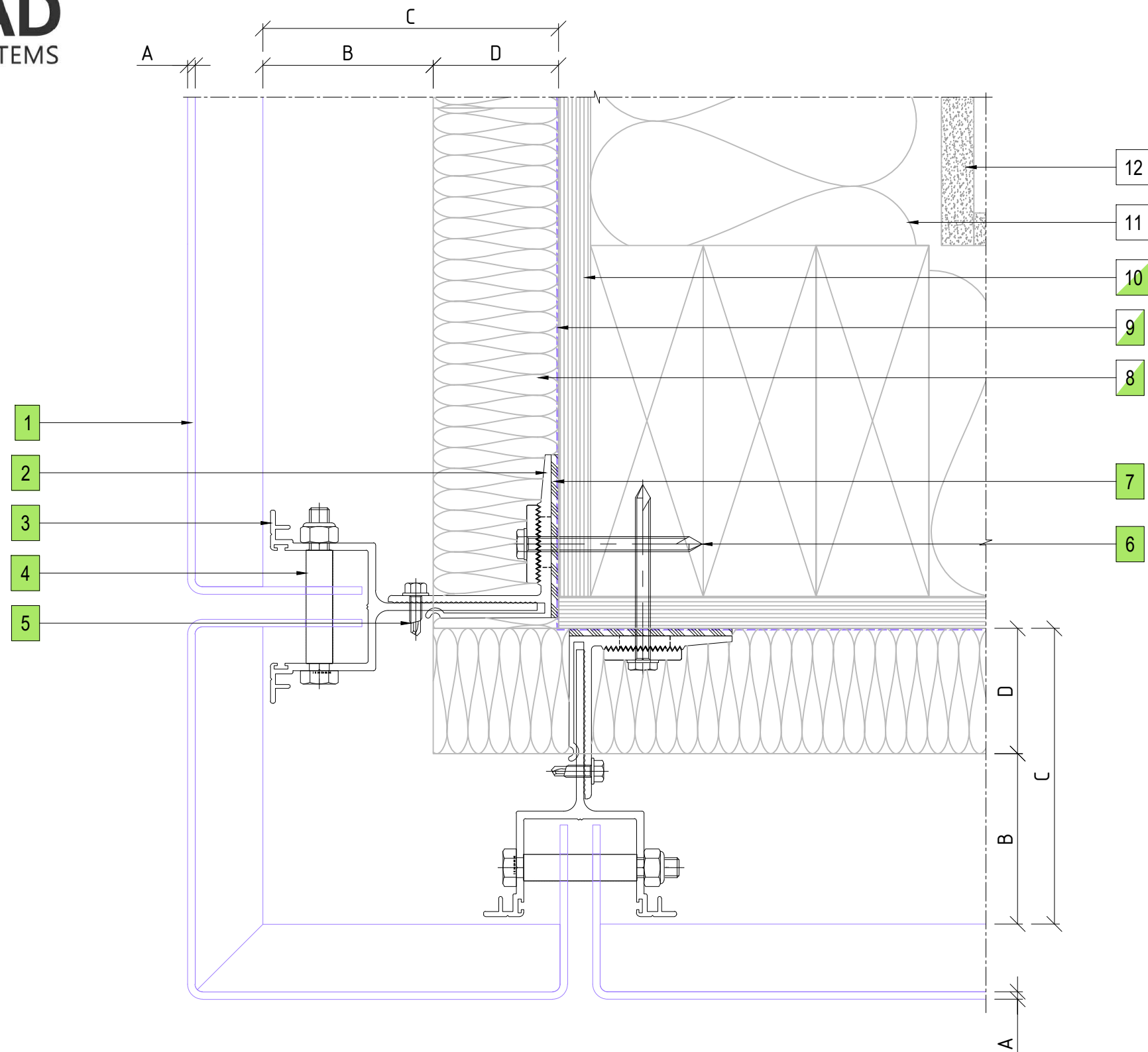

06 EXTERNAL CORNER PANEL DETAIL
ENCLAD™ SOLID SHEET *

LEGEND

| | |
|----|---|
| A | ENCLAD™ SOLID SHEET * |
| B | 53mm - 69mm NOMINAL VENTILATION ZONE (AIR GAP) |
| C | ** 119mm SYSTEM CAVITY TO ACCOMMODATE 50mm THICK INSULATION |
| D | ** 50mm INSULATION (OPTION BY INSITE) FIRE STOP (OPTION BY INSITE) |
| ** | OTHER OPTIONS AVAILABLE (PROJECT SPECIFIC) 128mm SYSTEM CAVITY FOR 75mm THICK INSULATION 153mm SYSTEM CAVITY FOR 100mm THICK INSULATION |

PARTS LIST

| | |
|----|--|
| 1 | ENCLAD™ FOLDED ALUMINIUM PANEL |
| 2 | ENCLAD EN01 ALUMINIUM HELPING HAND BRACKET |
| 3 | ENCLAD EN01 ALUMINIUM CHANNEL PROFILE |
| 4 | ENCLAD FIXING FOR HOOK (STAINLESS STEEL) |
| 5 | ENCLAD BRACKET TO RAIL FIXING (STAINLESS STEEL) |
| 6 | ENCLAD HOST STRUCTURAL FIXING (STAINLESS STEEL) |
| 7 | ENCLAD THERMAL ISOLATION PAD |
| 8 | CAVITY INSULATION (OPTION BY INSITE) |
| 9 | BUILDING WRAP / MEMBRANE (OPTION BY INSITE) |
| 10 | RIGID AIR BARRIER / SHEATHING BOARD (OPTION BY INSITE) |
| 11 | WALL INSULATION (BY OTHERS) |
| 12 | PLASTER BOARD (BY OTHERS) |

*** SOLID SHEET OPTIONS**

| | |
|---|----------------------|
| • | SOLID ALUMINIUM |
| • | ALUCOLUX® |
| • | PERFORATED ALUMINIUM |
| • | STAINLESS STEEL |
| • | COPPER |
| • | SOLID ZINC |

Cladding Type :

ENCLAD™ SOLID SHEET *

Support System :

ENCLAD™ EN04 - HOOK ON SECRET FIXED

Detail Description :

EXTERNAL CORNER PANEL DETAIL(PLAN VIEW)

Scale @ A3 : 1:2

Rev. : NOV 2022

System # :

SS-EN04-HOP-SF2

Detail # :

06

ENCLAD™ RAINSCREEN SYSTEMS

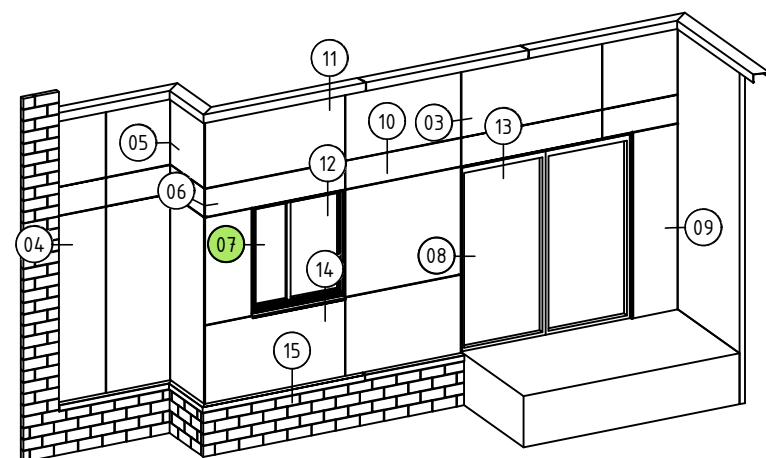
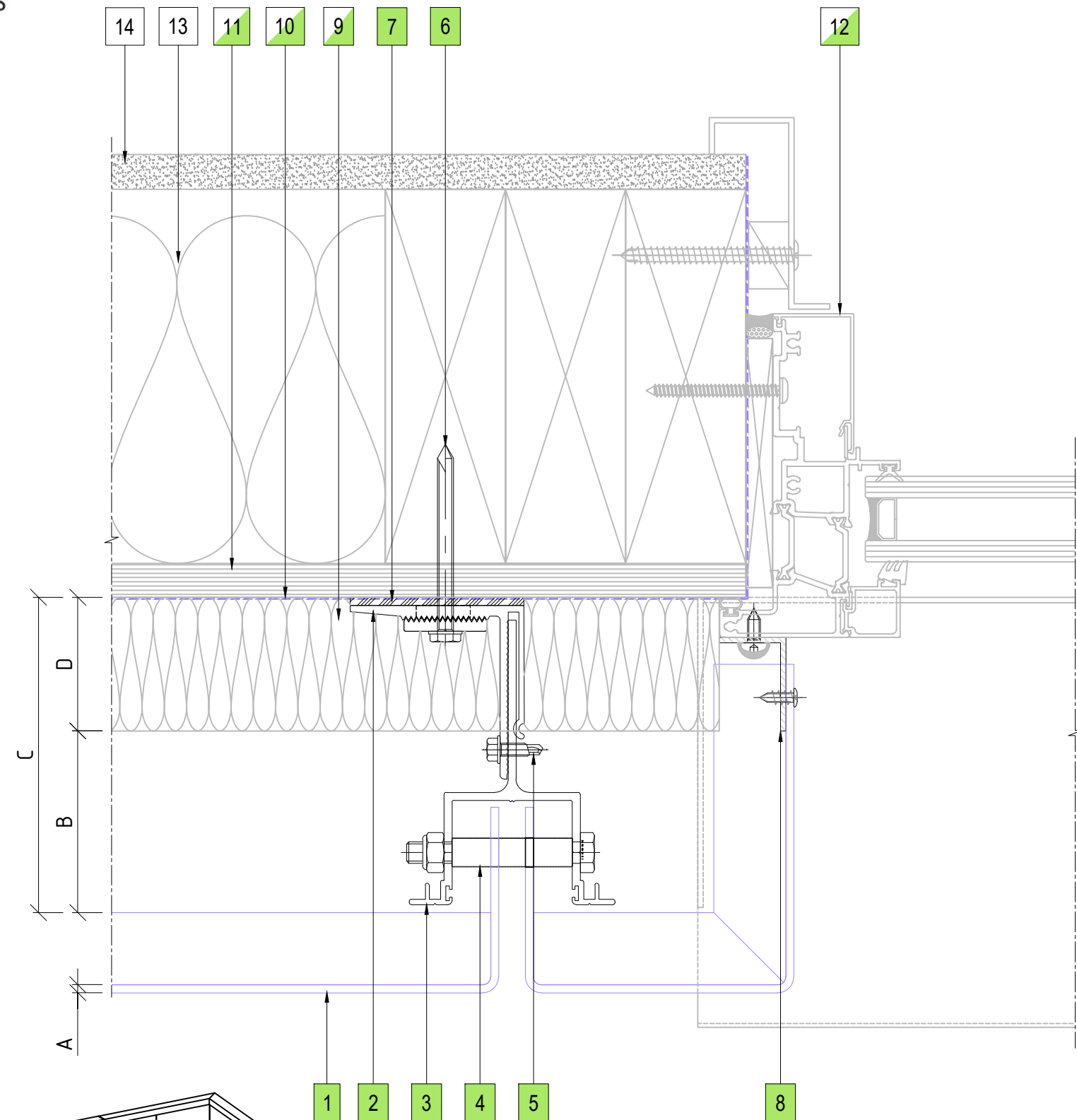

07 WINDOW JAMB DETAIL
ENCLAD™ SOLID SHEET *

LEGEND

| | |
|----|---|
| A | ENCLAD™ SOLID SHEET * |
| B | 53mm - 69mm NOMINAL VENTILATION ZONE (AIR GAP) |
| C | ** 119mm SYSTEM CAVITY TO ACCOMMODATE 50mm THICK INSULATION |
| D | ** 50mm INSULATION (OPTION BY INSITE) FIRE STOP (OPTION BY INSITE) |
| ** | OTHER OPTIONS AVAILABLE (PROJECT SPECIFIC) 128mm SYSTEM CAVITY FOR 75mm THICK INSULATION 153mm SYSTEM CAVITY FOR 100mm THICK INSULATION |

PARTS LIST

| | |
|----|--|
| 1 | ENCLAD™ FOLDED ALUMINIUM PANEL |
| 2 | ENCLAD EN01 ALUMINIUM HELPING HAND BRACKET |
| 3 | ENCLAD EN01 ALUMINIUM CHANNEL PROFILE |
| 4 | ENCLAD FIXING FOR HOOK (STAINLESS STEEL) |
| 5 | ENCLAD BRACKET TO RAIL FIXING (STAINLESS STEEL) |
| 6 | ENCLAD HOST STRUCTURAL FIXING (STAINLESS STEEL) |
| 7 | ENCLAD THERMAL ISOLATION PAD |
| 8 | ENCLAD ALUMINIUM CLOSURE |
| 9 | CAVITY INSULATION (OPTION BY INSITE) |
| 10 | BUILDING WRAP / MEMBRANE (OPTION BY INSITE) |
| 11 | RIGID AIR BARRIER / SHEATHING BOARD (OPTION BY INSITE) |
| 12 | ALUMINIUM DOORS, WINDOWS & REVEALS (OPTION BY INSITE) |
| 13 | WALL INSULATION (BY OTHERS) |
| 14 | PLASTER BOARD (BY OTHERS) |

*** SOLID SHEET OPTIONS**

| | |
|---|----------------------|
| • | SOLID ALUMINIUM |
| • | ALUCOLUX® |
| • | PERFORATED ALUMINIUM |
| • | STAINLESS STEEL |
| • | COPPER |
| • | SOLID ZINC |

Cladding Type :

ENCLAD™ SOLID SHEET *

Support System :

ENCLAD™ EN04 - HOOK ON SECRET FIXED

Detail Description :

WINDOW JAMB DETAIL(PLAN VIEW)

Scale @ A3 : 1:2

Rev. : NOV 2022

System # :

SS-EN04-HOP-SF2

Detail # :

07

ENCLAD™ RAINSCREEN SYSTEMS

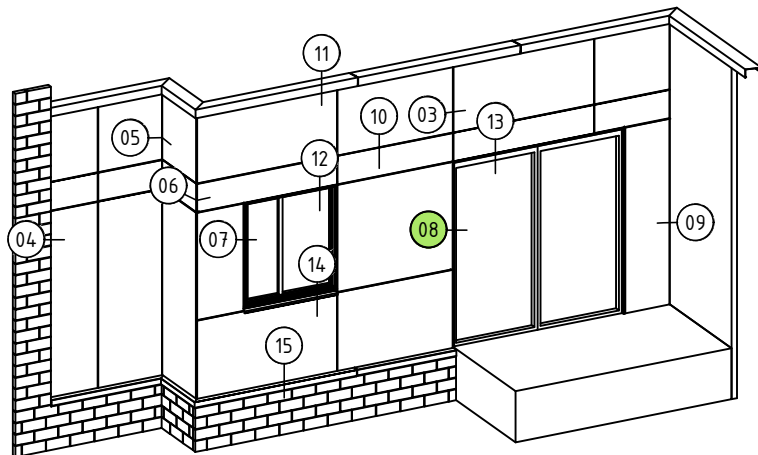
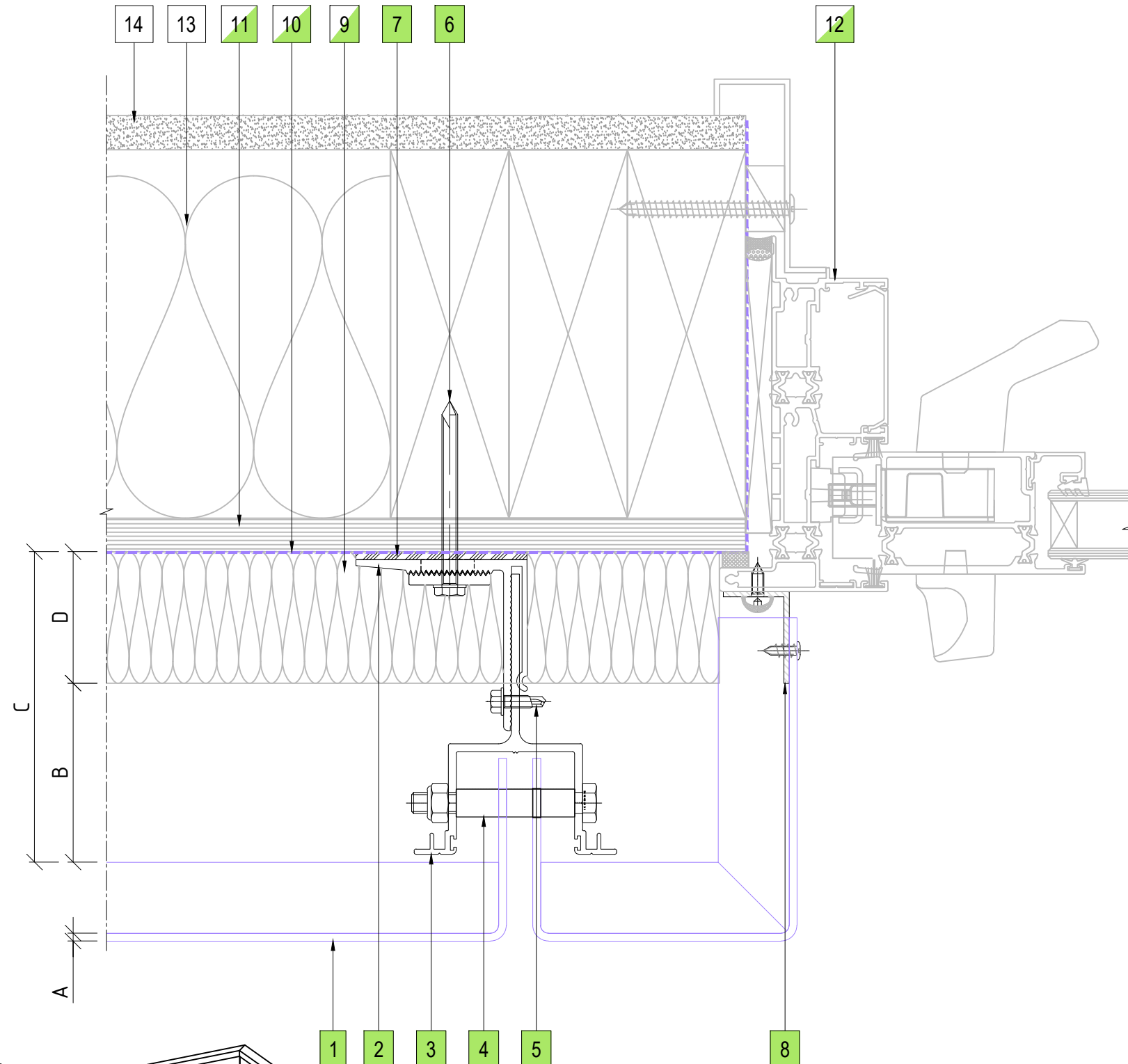

08 DOOR JAMB DETAIL
ENCLAD™ SOLID SHEET *

LEGEND

| | |
|----|---|
| A | ENCLAD™ SOLID SHEET * |
| B | 53mm - 69mm NOMINAL VENTILATION ZONE (AIR GAP) |
| C | ** 119mm SYSTEM CAVITY TO ACCOMMODATE 50mm THICK INSULATION |
| D | ** 50mm INSULATION (OPTION BY INSITE) FIRE STOP (OPTION BY INSITE) |
| ** | OTHER OPTIONS AVAILABLE (PROJECT SPECIFIC) 128mm SYSTEM CAVITY FOR 75mm THICK INSULATION 153mm SYSTEM CAVITY FOR 100mm THICK INSULATION |

PARTS LIST

| | |
|----|--|
| 1 | ENCLAD™ FOLDED ALUMINIUM PANEL |
| 2 | ENCLAD EN01 ALUMINIUM HELPING HAND BRACKET |
| 3 | ENCLAD EN01 ALUMINIUM CHANNEL PROFILE |
| 4 | ENCLAD FIXING FOR HOOK (STAINLESS STEEL) |
| 5 | ENCLAD BRACKET TO RAIL FIXING (STAINLESS STEEL) |
| 6 | ENCLAD HOST STRUCTURAL FIXING (STAINLESS STEEL) |
| 7 | ENCLAD THERMAL ISOLATION PAD |
| 8 | ENCLAD ALUMINIUM CLOSURE |
| 9 | CAVITY INSULATION (OPTION BY INSITE) |
| 10 | BUILDING WRAP / MEMBRANE (OPTION BY INSITE) |
| 11 | RIGID AIR BARRIER / SHEATHING BOARD (OPTION BY INSITE) |
| 12 | ALUMINIUM DOORS, WINDOWS & REVEALS (OPTION BY INSITE) |
| 13 | WALL INSULATION (BY OTHERS) |
| 14 | PLASTER BOARD (BY OTHERS) |

*** SOLID SHEET OPTIONS**

| | |
|---|----------------------|
| • | SOLID ALUMINIUM |
| • | ALUCOLUX® |
| • | PERFORATED ALUMINIUM |
| • | STAINLESS STEEL |
| • | COPPER |
| • | SOLID ZINC |

Cladding Type :

ENCLAD™ SOLID SHEET *

Support System :

ENCLAD™ EN04 - HOOK ON SECRET FIXED

Detail Description :

DOOR JAMB DETAIL(PLAN VIEW)

Scale @ A3 : 1:2

Rev. : NOV 2022

System # :

SS-EN04-HOP-SF2

Detail # :

08

ENCLAD™ RAINSCREEN SYSTEMS

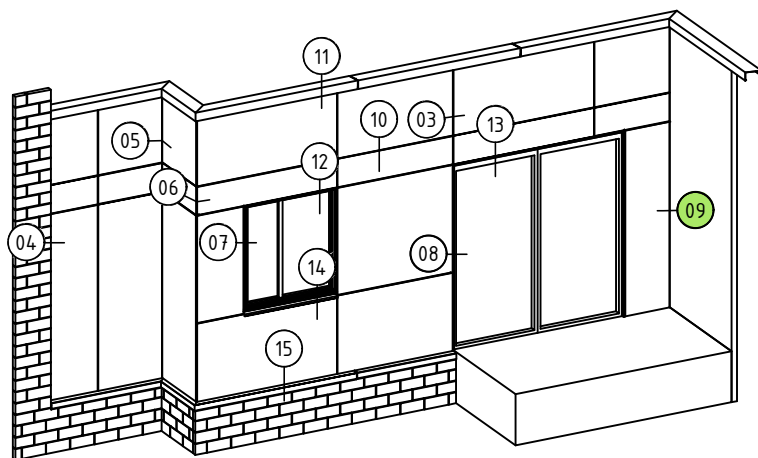
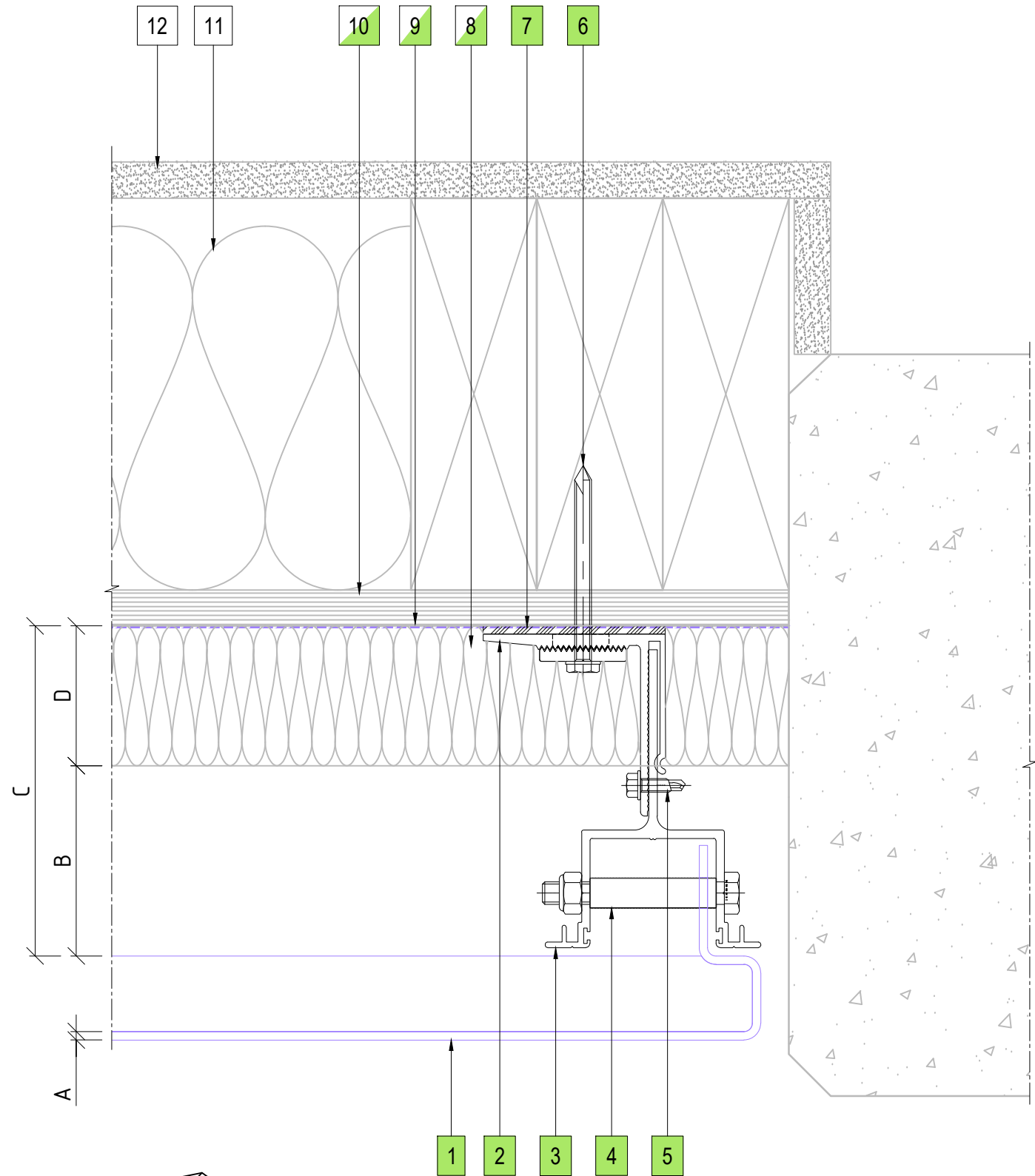

09 CONCRETE WALL ABUTMENT DETAIL
ENCLAD™ SOLID SHEET *

COPYRIGHT : THESE DESIGNS, DETAILS AND/OR SPECIFICATIONS AND THE COPYRIGHT THEREIN, REMAIN THE PROPERTY OF INSITE FACADES LTD.

DISCLAIMER : THESE DETAILS ARE PROVIDED FOR INDICATIVE PURPOSES ONLY. CONSTRUCTION/SYSTEM DETAILS CAN VARY DEPENDING ON PROJECT SPECIFIC SPECIFICATION AND ENGINEERING REQUIREMENTS. THE DESIGNER IS RESPONSIBLE FOR ENSURING DETAILS SATISFY ALL NEW ZEALAND BUILDING CODE CLAUSES. THE DESIGNER IS RESPONSIBLE FOR ENSURING BUILDING WRAPS, FIRESTOPS AND INSULATION/SPECIFICATION COMPLY WITH MANUFACTURERS RECOMMENDATIONS AND NZBC REGULATIONS. REFER TO INSITE WEBSITE FOR FULL TERMS AND CONDITIONS.

LEGEND

| | |
|----|---|
| A | ENCLAD™ SOLID SHEET * |
| B | 53mm - 69mm NOMINAL VENTILATION ZONE (AIR GAP) |
| C | ** 119mm SYSTEM CAVITY TO ACCOMMODATE 50mm THICK INSULATION |
| D | ** 50mm INSULATION (OPTION BY INSITE) FIRE STOP (OPTION BY INSITE) |
| ** | OTHER OPTIONS AVAILABLE (PROJECT SPECIFIC) 128mm SYSTEM CAVITY FOR 75mm THICK INSULATION 153mm SYSTEM CAVITY FOR 100mm THICK INSULATION |

PARTS LIST

| | |
|----|--|
| 1 | ENCLAD™ FOLDED ALUMINIUM PANEL |
| 2 | ENCLAD EN01 ALUMINIUM HELPING HAND BRACKET |
| 3 | ENCLAD EN01 ALUMINIUM CHANNEL PROFILE |
| 4 | ENCLAD FIXING FOR HOOK (STAINLESS STEEL) |
| 5 | ENCLAD BRACKET TO RAIL FIXING (STAINLESS STEEL) |
| 6 | ENCLAD HOST STRUCTURAL FIXING (STAINLESS STEEL) |
| 7 | ENCLAD THERMAL ISOLATION PAD |
| 8 | CAVITY INSULATION (OPTION BY INSITE) |
| 9 | BUILDING WRAP / MEMBRANE (OPTION BY INSITE) |
| 10 | RIGID AIR BARRIER / SHEATHING BOARD (OPTION BY INSITE) |
| 11 | WALL INSULATION (BY OTHERS) |
| 12 | PLASTER BOARD (BY OTHERS) |

*** SOLID SHEET OPTIONS**

- SOLID ALUMINIUM
- ALUCOLUX®
- PERFORATED ALUMINIUM
- STAINLESS STEEL
- COPPER
- SOLID ZINC

Cladding Type :

ENCLAD™ SOLID SHEET *

Support System :

ENCLAD™ EN04 - HOOK ON SECRET FIXED

Detail Description :

CONCRETE WALL ABUTMENT DETAIL(PLAN VIEW)

Scale @ A3 : 1:2

Rev. : NOV 2022

System # :

SS-EN04-HOP-SF2

Detail # :

09

ENCLAD™ RAINSCREEN SYSTEMS

LEGEND

| | |
|----|---|
| A | ENCLAD™ SOLID SHEET * |
| B | 53mm - 69mm NOMINAL VENTILATION ZONE (AIR GAP) |
| C | ** 119mm SYSTEM CAVITY TO ACCOMMODATE 50mm THICK INSULATION |
| D | ** 50mm INSULATION (OPTION BY INSITE) FIRE STOP (OPTION BY INSITE) |
| ** | OTHER OPTIONS AVAILABLE (PROJECT SPECIFIC) 128mm SYSTEM CAVITY FOR 75mm THICK INSULATION 153mm SYSTEM CAVITY FOR 100mm THICK INSULATION |

PARTS LIST

| | |
|----|--|
| 1 | ENCLAD™ FOLDED ALUMINIUM PANEL |
| 2 | ENCLAD EN01 ALUMINIUM HELPING HAND BRACKET |
| 3 | ENCLAD EN01 ALUMINIUM CHANNEL PROFILE |
| 4 | ENCLAD FIXING FOR HOOK (STAINLESS STEEL) |
| 5 | ENCLAD BRACKET TO RAIL FIXING (STAINLESS STEEL) |
| 6 | ENCLAD HOST STRUCTURAL FIXING (STAINLESS STEEL) |
| 7 | ENCLAD THERMAL ISOLATION PAD |
| 8 | ENCLAD FIXING FOR PANEL (STAINLESS STEEL) |
| 9 | CAVITY INSULATION (OPTION BY INSITE) |
| 10 | BUILDING WRAP / MEMBRANE (OPTION BY INSITE) |
| 11 | RIGID AIR BARRIER / SHEATHING BOARD (OPTION BY INSITE) |
| 12 | WALL INSULATION (BY OTHERS) |
| 13 | PLASTER BOARD (BY OTHERS) |

*** SOLID SHEET OPTIONS**

| | |
|---|----------------------|
| • | SOLID ALUMINIUM |
| • | ALUCOLUX® |
| • | PERFORATED ALUMINIUM |
| • | STAINLESS STEEL |
| • | COPPER |
| • | SOLID ZINC |

Cladding Type :

ENCLAD™ SOLID SHEET *

Support System :

ENCLAD™ EN04 - HOOK ON SECRET FIXED

Detail Description :

HORIZONTAL PANEL JOINT DETAIL (SECTION VIEW)

Scale @ A3 : 1:2

Rev. : NOV 2022

System # :

SS-EN04-HOP-SF2

Detail # :

10

ENCLAD™ RAINSCREEN SYSTEMS

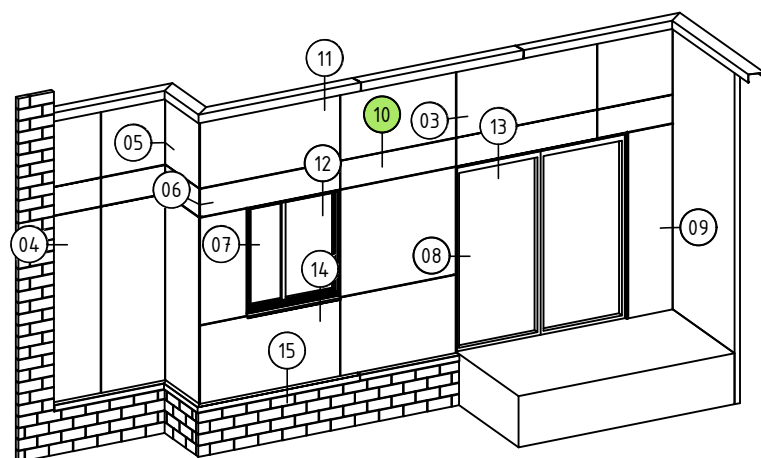
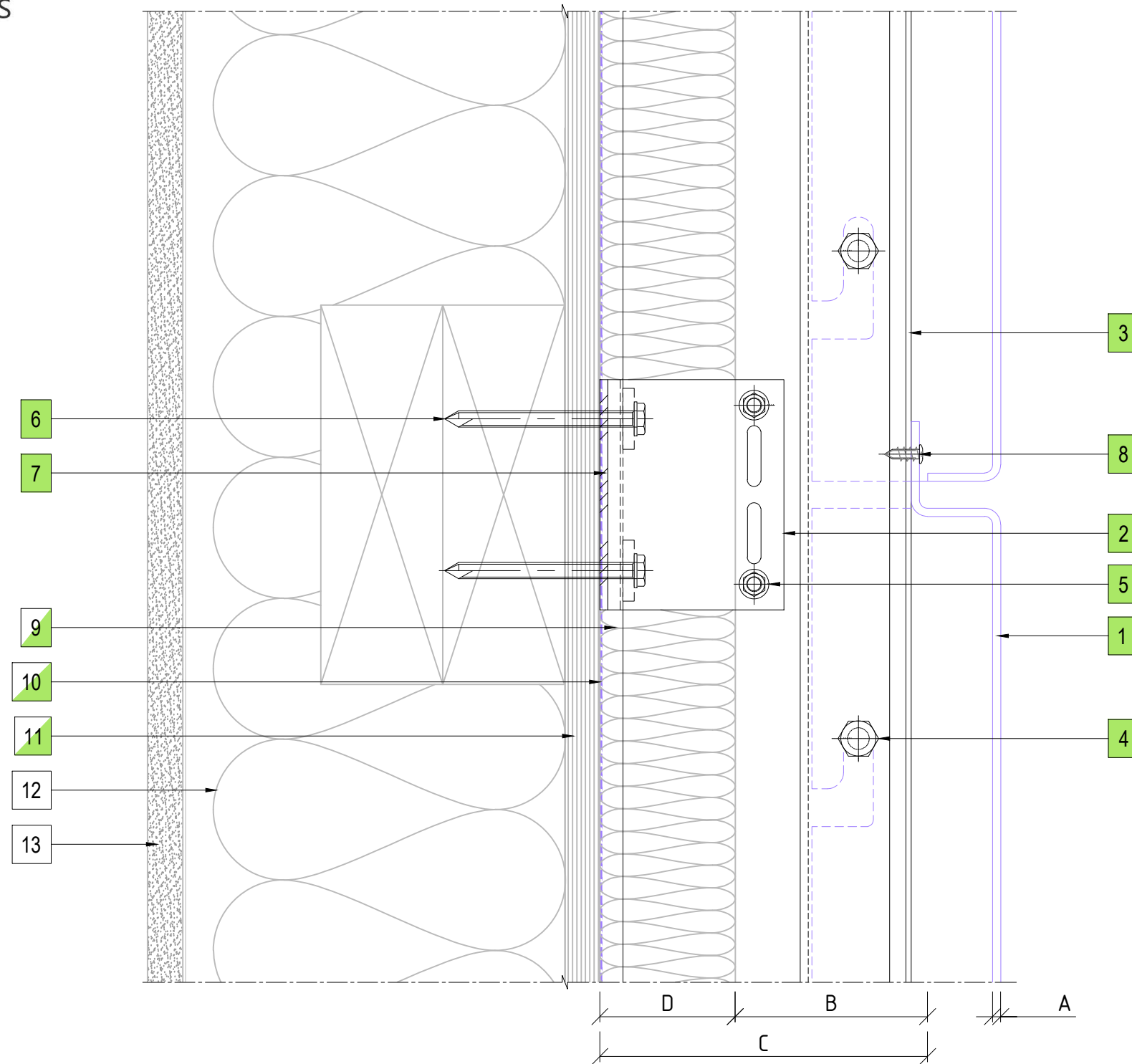

10 HORIZONTAL PANEL JOINT DETAIL
ENCLAD™ SOLID SHEET *

LEGEND

| | |
|----|---|
| A | ENCLAD™ SOLID SHEET * |
| B | 53mm - 69mm NOMINAL VENTILATION ZONE (AIR GAP) |
| C | ** 119mm SYSTEM CAVITY TO ACCOMMODATE 50mm THICK INSULATION |
| D | ** 50mm INSULATION (OPTION BY INSITE) FIRE STOP (OPTION BY INSITE) |
| ** | OTHER OPTIONS AVAILABLE (PROJECT SPECIFIC) 128mm SYSTEM CAVITY FOR 75mm THICK INSULATION 153mm SYSTEM CAVITY FOR 100mm THICK INSULATION |

PARTS LIST

| | |
|----|--|
| 1 | ENCLAD™ FOLDED ALUMINIUM PANEL |
| 2 | ENCLAD EN01 ALUMINIUM HELPING HAND BRACKET |
| 3 | ENCLAD EN01 ALUMINIUM CHANNEL PROFILE |
| 4 | ENCLAD FIXING FOR HOOK (STAINLESS STEEL) |
| 5 | ENCLAD BRACKET TO RAIL FIXING (STAINLESS STEEL) |
| 6 | ENCLAD HOST STRUCTURAL FIXING (STAINLESS STEEL) |
| 7 | ENCLAD THERMAL ISOLATION PAD |
| 8 | ENCLAD ALUMINIUM FLASHING |
| 9 | ENCLAD ALUMINIUM BRACKET |
| 10 | CAVITY INSULATION (OPTION BY INSITE) |
| 11 | BUILDING WRAP / MEMBRANE (OPTION BY INSITE) |
| 12 | RIGID AIR BARRIER / SHEATHING BOARD (OPTION BY INSITE) |
| 13 | WALL INSULATION (BY OTHERS) |
| 14 | PLASTER BOARD (BY OTHERS) |

*** SOLID SHEET OPTIONS**

| | |
|---|----------------------|
| • | SOLID ALUMINIUM |
| • | ALUCOLUX® |
| • | PERFORATED ALUMINIUM |
| • | STAINLESS STEEL |
| • | COPPER |
| • | SOLID ZINC |

Cladding Type :

ENCLAD™ SOLID SHEET *

Support System :

ENCLAD™ EN04 - HOOK ON SECRET FIXED

Detail Description :

PARAPET FLASHING DETAIL(SECTION VIEW)

Scale @ A3 : 1:2

Rev. : NOV 2022

System # :

SS-EN04-HOP-SF2

Detail # :

11

ENCLAD™ RAINSCREEN SYSTEMS

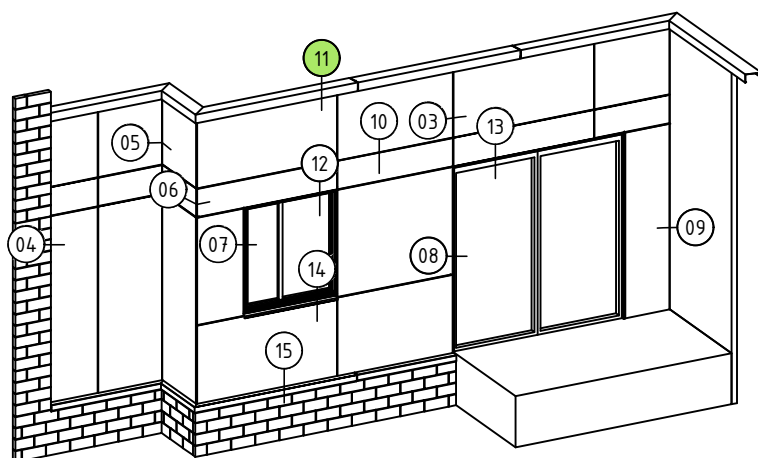
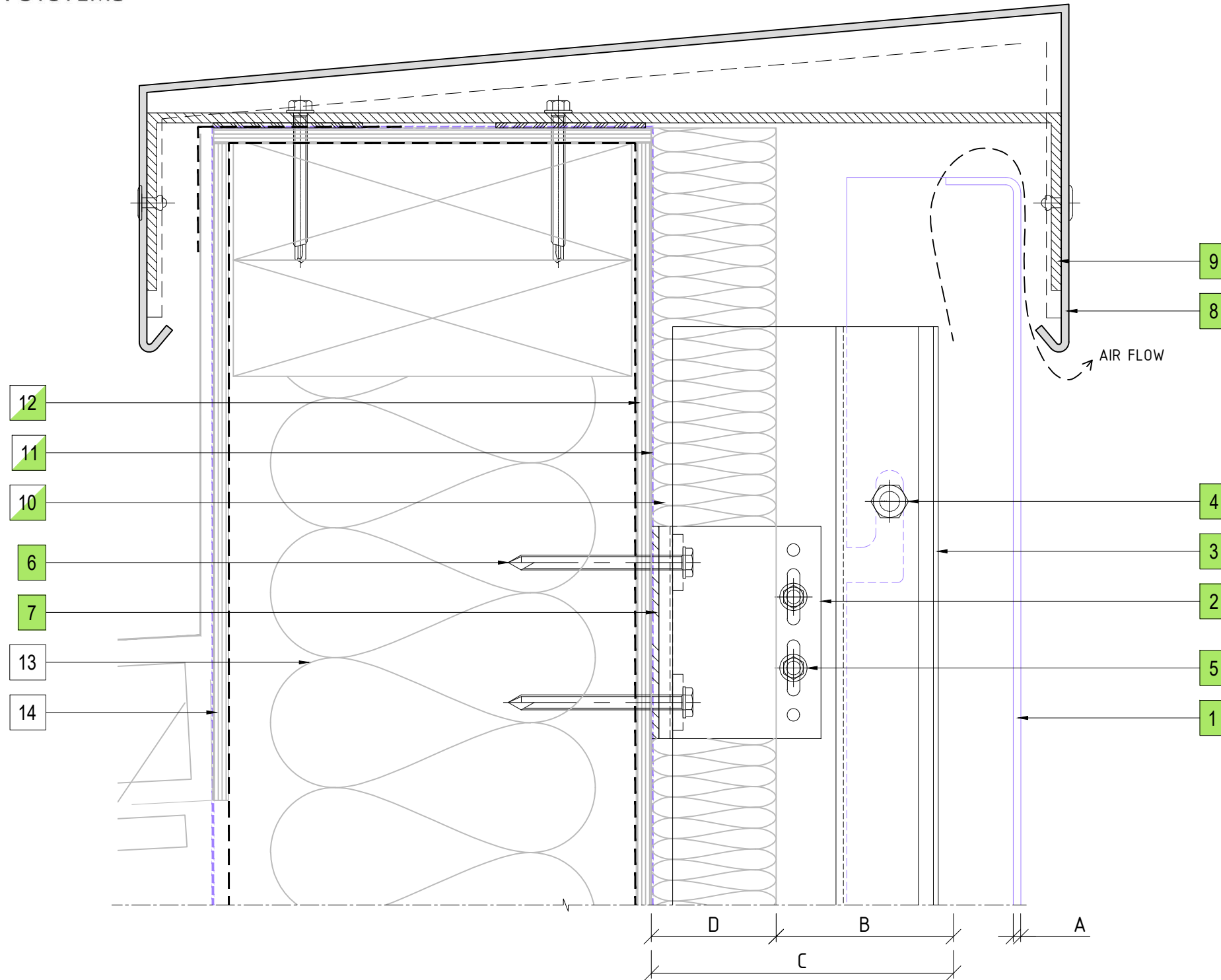

11 PARAPET FLASHING DETAIL
ENCLAD™ SOLID SHEET *

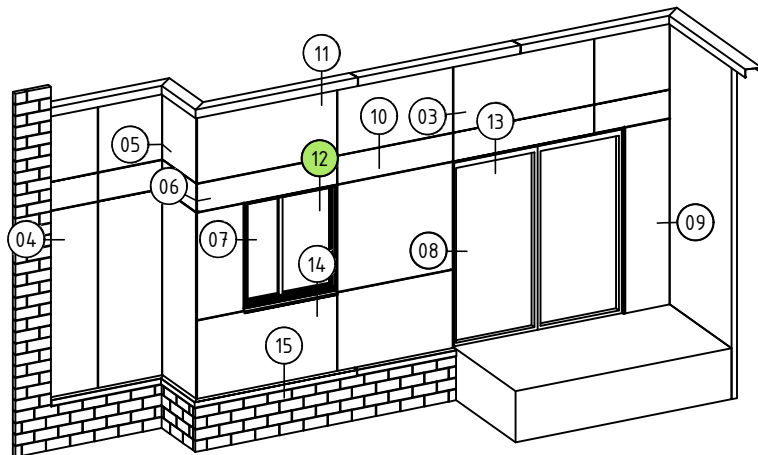
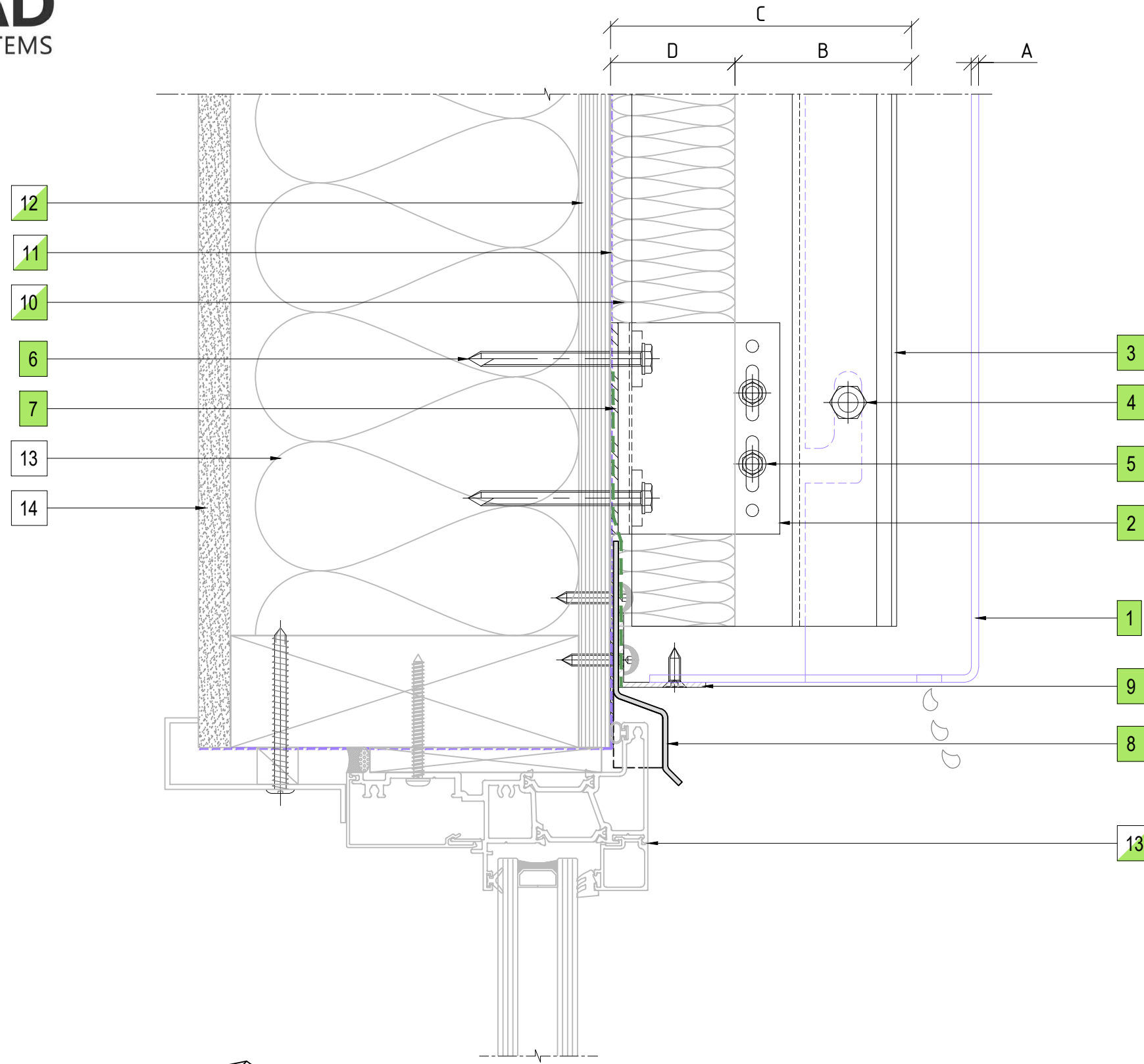

12 WINDOW HEAD DETAIL
ENCLAD™ SOLID SHEET *

LEGEND

| | |
|----|---|
| A | ENCLAD™ SOLID SHEET * |
| B | 53mm - 69mm NOMINAL VENTILATION ZONE (AIR GAP) |
| C | ** 119mm SYSTEM CAVITY TO ACCOMMODATE 50mm THICK INSULATION |
| D | ** 50mm INSULATION (OPTION BY INSITE) FIRE STOP (OPTION BY INSITE) |
| ** | OTHER OPTIONS AVAILABLE (PROJECT SPECIFIC) 128mm SYSTEM CAVITY FOR 75mm THICK INSULATION 153mm SYSTEM CAVITY FOR 100mm THICK INSULATION |

PARTS LIST

| | |
|----|--|
| 1 | ENCLAD™ FOLDED ALUMINIUM PANEL |
| 2 | ENCLAD EN01 ALUMINIUM HELPING HAND BRACKET |
| 3 | ENCLAD EN01 ALUMINIUM CHANNEL PROFILE |
| 4 | ENCLAD FIXING FOR HOOK (STAINLESS STEEL) |
| 5 | ENCLAD BRACKET TO RAIL FIXING (STAINLESS STEEL) |
| 6 | ENCLAD HOST STRUCTURAL FIXING (STAINLESS STEEL) |
| 7 | ENCLAD THERMAL ISOLATION PAD |
| 8 | ENCLAD ALUMINIUM FLASHING |
| 9 | ENCLAD ALUMINIUM CLOSURE |
| 10 | CAVITY INSULATION (OPTION BY INSITE) |
| 11 | BUILDING WRAP / MEMBRANE (OPTION BY INSITE) |
| 12 | RIGID AIR BARRIER / SHEATHING BOARD (OPTION BY INSITE) |
| 13 | ALUMINIUM DOORS, WINDOWS & REVEALS (OPTION BY INSITE) |
| 14 | WALL INSULATION (BY OTHERS) |
| 15 | PLASTER BOARD (BY OTHERS) |

*** SOLID SHEET OPTIONS**

| | |
|---|----------------------|
| • | SOLID ALUMINIUM |
| • | ALUCOLUX® |
| • | PERFORATED ALUMINIUM |
| • | STAINLESS STEEL |
| • | COPPER |
| • | SOLID ZINC |

Cladding Type :

ENCLAD™ SOLID SHEET *

Support System :

ENCLAD™ EN04 - HOOK ON SECRET FIXED

Detail Description :

WINDOW HEAD DETAIL(SECTION VIEW)

Scale @ A3 : 1:2

Rev. : NOV 2022

System # :

SS-EN04-HOP-SF2

Detail # :

12

ENCLAD™ RAINSCREEN SYSTEMS

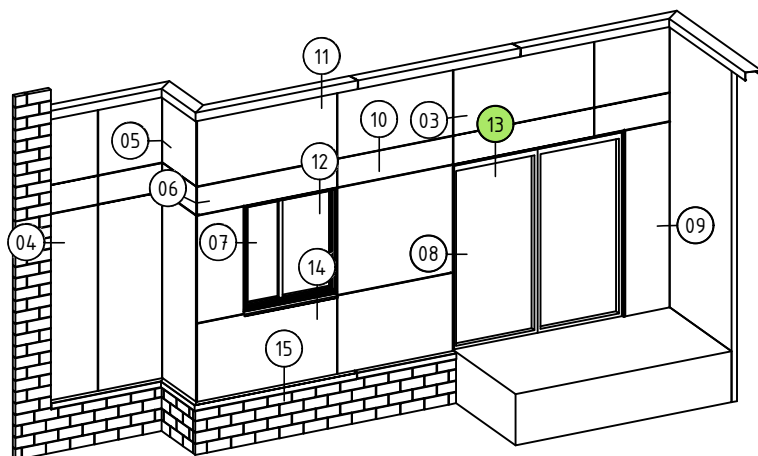
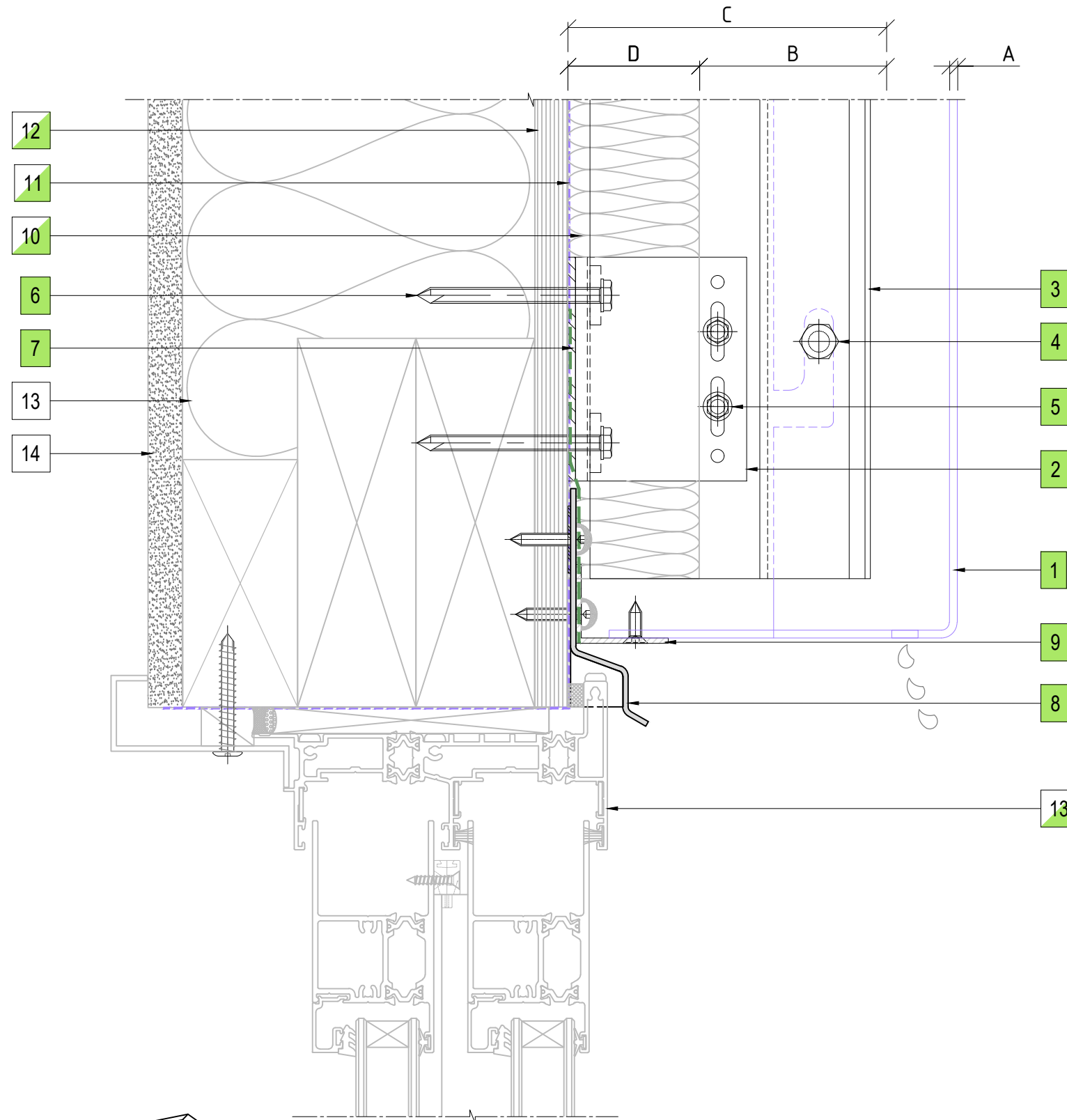

13 DOOR HEAD DETAIL
ENCLAD™ SOLID SHEET *

LEGEND

| | |
|----|---|
| A | ENCLAD™ SOLID SHEET * |
| B | 53mm - 69mm NOMINAL VENTILATION ZONE (AIR GAP) |
| C | ** 119mm SYSTEM CAVITY TO ACCOMMODATE 50mm THICK INSULATION |
| D | ** 50mm INSULATION (OPTION BY INSITE) FIRE STOP (OPTION BY INSITE) |
| ** | OTHER OPTIONS AVAILABLE (PROJECT SPECIFIC) 128mm SYSTEM CAVITY FOR 75mm THICK INSULATION 153mm SYSTEM CAVITY FOR 100mm THICK INSULATION |

PARTS LIST

| | |
|----|--|
| 1 | ENCLAD™ FOLDED ALUMINIUM PANEL |
| 2 | ENCLAD EN01 ALUMINIUM HELPING HAND BRACKET |
| 3 | ENCLAD EN01 ALUMINIUM CHANNEL PROFILE |
| 4 | ENCLAD FIXING FOR HOOK (STAINLESS STEEL) |
| 5 | ENCLAD BRACKET TO RAIL FIXING (STAINLESS STEEL) |
| 6 | ENCLAD HOST STRUCTURAL FIXING (STAINLESS STEEL) |
| 7 | ENCLAD THERMAL ISOLATION PAD |
| 8 | ENCLAD ALUMINIUM FLASHING |
| 9 | ENCLAD ALUMINIUM CLOSURE |
| 10 | CAVITY INSULATION (OPTION BY INSITE) |
| 11 | BUILDING WRAP / MEMBRANE (OPTION BY INSITE) |
| 12 | RIGID AIR BARRIER / SHEATHING BOARD (OPTION BY INSITE) |
| 13 | ALUMINIUM DOORS, WINDOWS & REVEALS (OPTION BY INSITE) |
| 14 | WALL INSULATION (BY OTHERS) |
| 15 | PLASTER BOARD (BY OTHERS) |

*** SOLID SHEET OPTIONS**

| | |
|---|----------------------|
| • | SOLID ALUMINIUM |
| • | ALUCOLUX® |
| • | PERFORATED ALUMINIUM |
| • | STAINLESS STEEL |
| • | COPPER |
| • | SOLID ZINC |

Cladding Type :

ENCLAD™ SOLID SHEET *

Support System :

ENCLAD™ EN04 - HOOK ON SECRET FIXED

Detail Description :

DOOR HEAD DETAIL(SECTION VIEW)

Scale @ A3 : 1:2

Rev. : NOV 2022

System # :

SS-EN04-HOP-SF2

Detail # :

13

ENCLAD™ RAINSCREEN SYSTEMS

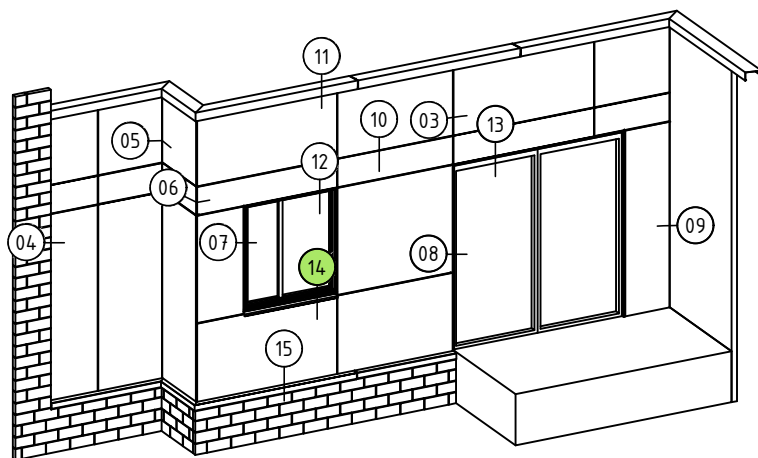
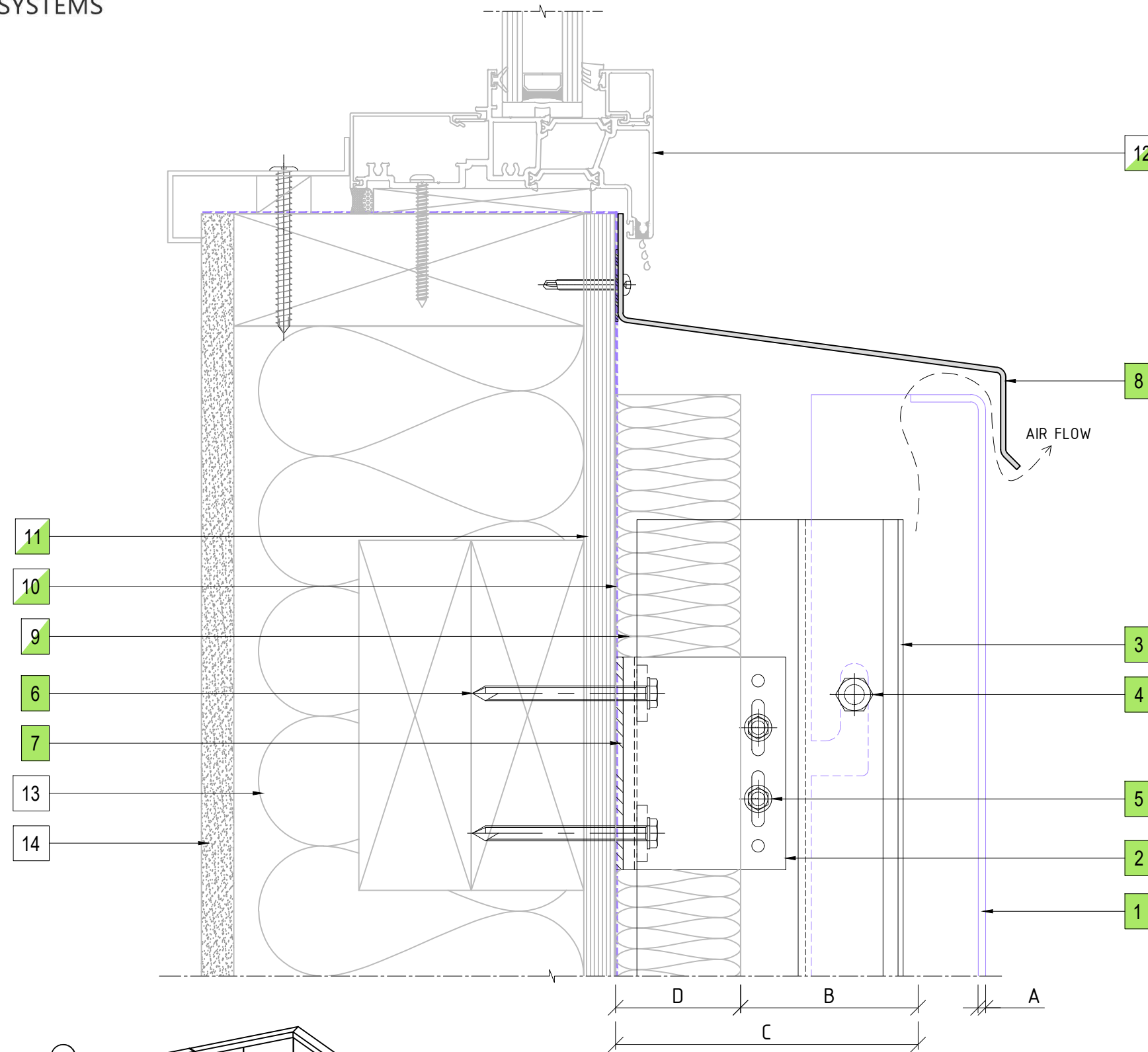

14 WINDOW SILL DETAIL
ENCLAD™ SOLID SHEET *

LEGEND

| | |
|----|---|
| A | ENCLAD™ SOLID SHEET * |
| B | 53mm - 69mm NOMINAL VENTILATION ZONE (AIR GAP) |
| C | ** 119mm SYSTEM CAVITY TO ACCOMMODATE 50mm THICK INSULATION |
| D | ** 50mm INSULATION (OPTION BY INSITE) FIRE STOP (OPTION BY INSITE) |
| ** | OTHER OPTIONS AVAILABLE (PROJECT SPECIFIC) 128mm SYSTEM CAVITY FOR 75mm THICK INSULATION 153mm SYSTEM CAVITY FOR 100mm THICK INSULATION |

PARTS LIST

| | |
|----|--|
| 1 | ENCLAD™ FOLDED ALUMINIUM PANEL |
| 2 | ENCLAD EN01 ALUMINIUM HELPING HAND BRACKET |
| 3 | ENCLAD EN01 ALUMINIUM CHANNEL PROFILE |
| 4 | ENCLAD FIXING FOR HOOK (STAINLESS STEEL) |
| 5 | ENCLAD BRACKET TO RAIL FIXING (STAINLESS STEEL) |
| 6 | ENCLAD HOST STRUCTURAL FIXING (STAINLESS STEEL) |
| 7 | ENCLAD THERMAL ISOLATION PAD |
| 8 | ENCLAD ALUMINIUM FLASHING |
| 9 | CAVITY INSULATION (OPTION BY INSITE) |
| 10 | BUILDING WRAP / MEMBRANE (OPTION BY INSITE) |
| 11 | RIGID AIR BARRIER / SHEATHING BOARD (OPTION BY INSITE) |
| 12 | ALUMINIUM DOORS, WINDOWS & REVEALS (OPTION BY INSITE) |
| 13 | WALL INSULATION (BY OTHERS) |
| 14 | PLASTER BOARD (BY OTHERS) |

*** SOLID SHEET OPTIONS**

| | |
|---|----------------------|
| • | SOLID ALUMINIUM |
| • | ALUCOLUX® |
| • | PERFORATED ALUMINIUM |
| • | STAINLESS STEEL |
| • | COPPER |
| • | SOLID ZINC |

Cladding Type :

ENCLAD™ SOLID SHEET *

Support System :

ENCLAD™ EN04 - HOOK ON SECRET FIXED

Detail Description :

WINDOW SILL DETAIL(SECTION VIEW)

Scale @ A3 : 1:2

Rev. : NOV 2022

System # :

SS-EN04-HOP-SF2

Detail # :

14

ENCLAD™ RAINSCREEN SYSTEMS

LEGEND

| | |
|----|---|
| A | ENCLAD™ SOLID SHEET * |
| B | 53mm - 69mm NOMINAL VENTILATION ZONE (AIR GAP) |
| C | ** 119mm SYSTEM CAVITY TO ACCOMMODATE 50mm THICK INSULATION |
| D | ** 50mm INSULATION (OPTION BY INSITE) FIRE STOP (OPTION BY INSITE) |
| ** | OTHER OPTIONS AVAILABLE (PROJECT SPECIFIC) 128mm SYSTEM CAVITY FOR 75mm THICK INSULATION 153mm SYSTEM CAVITY FOR 100mm THICK INSULATION |

PARTS LIST

| | |
|----|--|
| 1 | ENCLAD™ FOLDED ALUMINIUM PANEL |
| 2 | ENCLAD EN01 ALUMINIUM HELPING HAND BRACKET |
| 3 | ENCLAD EN01 ALUMINIUM CHANNEL PROFILE |
| 4 | ENCLAD FIXING FOR HOOK (STAINLESS STEEL) |
| 5 | ENCLAD BRACKET TO RAIL FIXING (STAINLESS STEEL) |
| 6 | ENCLAD HOST STRUCTURAL FIXING (STAINLESS STEEL) |
| 7 | ENCLAD THERMAL ISOLATION PAD |
| 8 | ENCLAD ALUMINIUM FLASHING |
| 9 | CAVITY INSULATION (OPTION BY INSITE) |
| 10 | BUILDING WRAP / MEMBRANE (OPTION BY INSITE) |
| 11 | RIGID AIR BARRIER / SHEATHING BOARD (OPTION BY INSITE) |
| 12 | WALL INSULATION (BY OTHERS) |
| 13 | PLASTER BOARD (BY OTHERS) |

*** SOLID SHEET OPTIONS**

| | |
|---|----------------------|
| • | SOLID ALUMINIUM |
| • | ALUCOLUX® |
| • | PERFORATED ALUMINIUM |
| • | STAINLESS STEEL |
| • | COPPER |
| • | SOLID ZINC |

Cladding Type :

ENCLAD™ SOLID SHEET *

Support System :

ENCLAD™ EN04 - HOOK ON SECRET FIXED

Detail Description :

BRICKWALL AT BASE DRIP DETAIL (SECTION VIEW)

Scale @ A3 : 1:2

Rev. : NOV 2022

System # :

SS-EN04-HOP-SF2

Detail # :

15

ENCLAD™ RAINSCREEN SYSTEMS

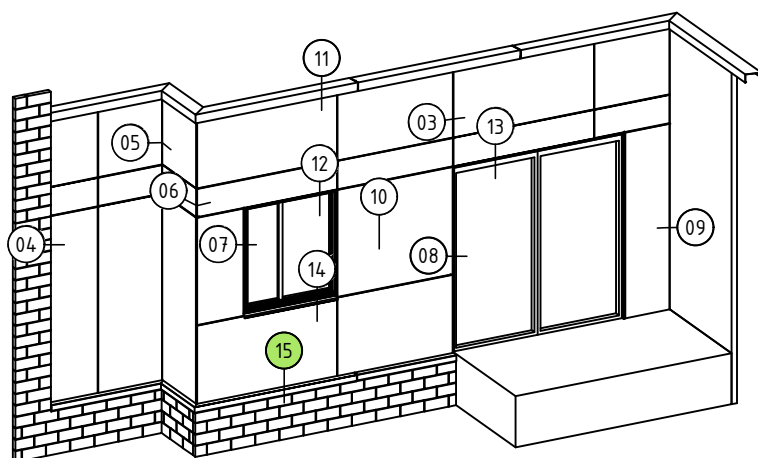
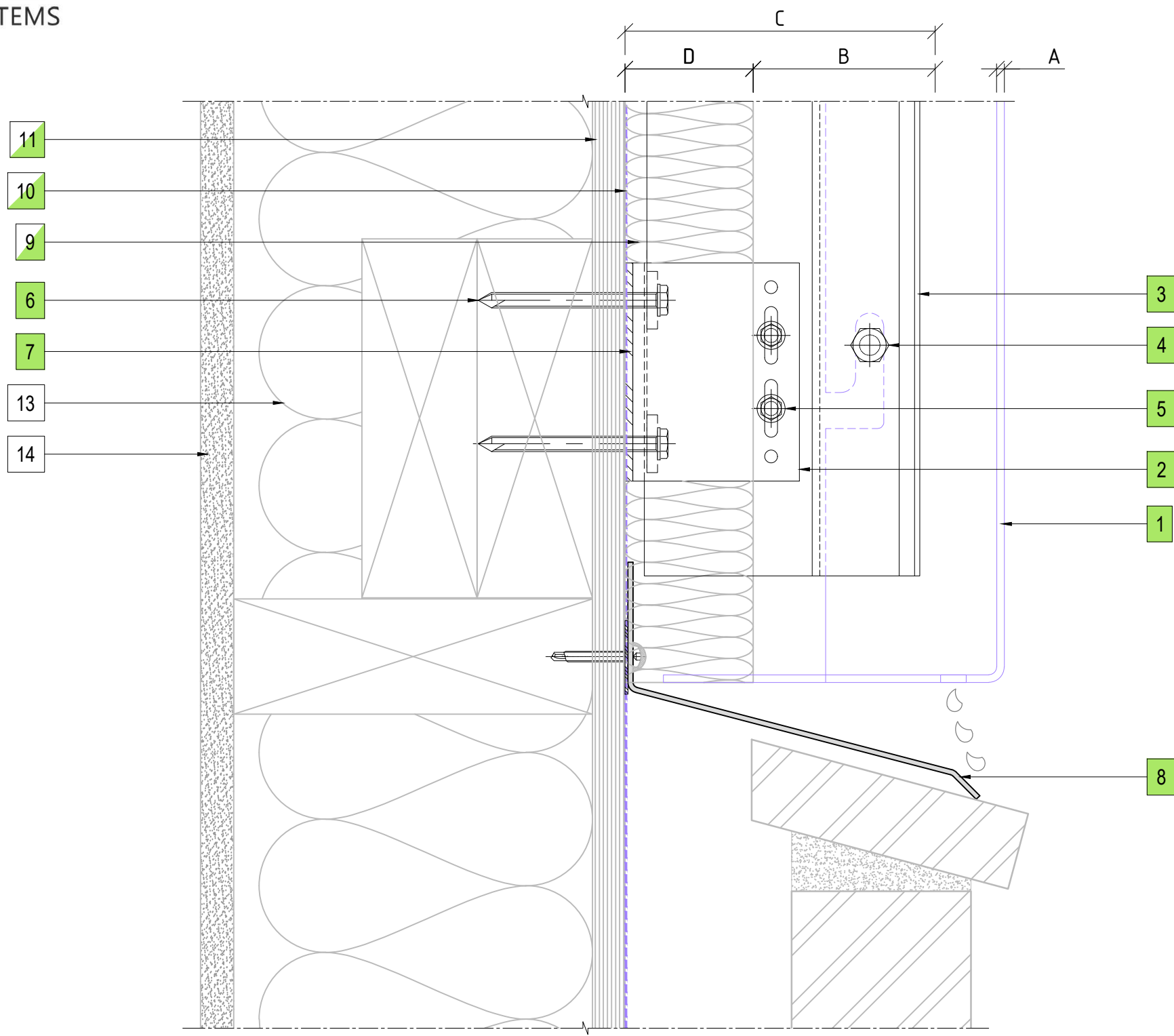

15 BRICKWALL AT BASE DRIP DETAIL
ENCLAD™ SOLID SHEET *