

# ENCLAD™ SOLID SHEET \*

## ENCLAD™ EN05-FF SUPPORT SYSTEM

### HOOK ON SECRET FIXED

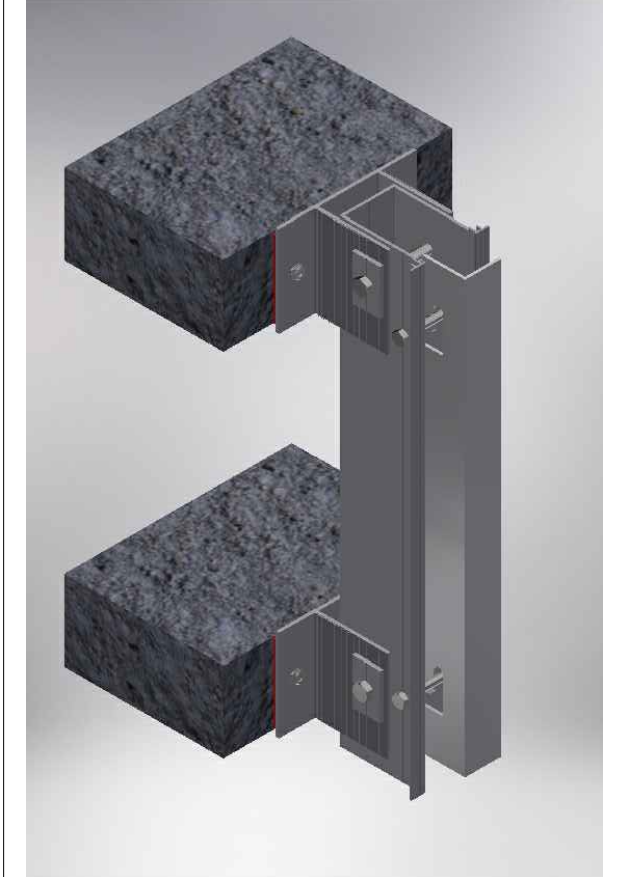

### DRAWING REGISTER

PAGE	DETAIL DESCRIPTION	DETAIL #	REV.
00/16	COVER PAGE	00	NOV 22
01/16	CAVITY SET OUT	01	NOV 22
02/16	SCHEMATIC	02	NOV 22
03/16	VERTICAL PANEL JOINT DETAIL (PLAN VIEW)	03	NOV 22
04/16	BRICKWALL ABUTMENT DETAIL (PLAN VIEW)	04	NOV 22
05/16	INTERNAL CORNER PANEL DETAIL (PLAN VIEW)	05	NOV 22
06/16	EXTERNAL CORNER PANEL DETAIL (PLAN VIEW)	06	NOV 22
07/16	WINDOW JAMB DETAIL (PLAN VIEW)	07	NOV 22
08/16	DOOR JAMB DETAIL (PLAN VIEW)	08	NOV 22
09/16	CONCRETE WALL ABUTMENT DETAIL (PLAN VIEW)	09	NOV 22
10/16	HORIZONTAL PANEL JOINT DETAIL (SECTION VIEW)	10	NOV 22
11/16	PARAPET FLASHING DETAIL (SECTION VIEW)	11	NOV 22
12/16	WINDOW HEAD DETAIL (SECTION VIEW)	12	NOV 22
13/16	DOOR HEAD DETAIL (SECTION VIEW)	13	NOV 22
14/16	WINDOW SILL DETAIL (SECTION VIEW)	14	NOV 22
15/16	BRICKWALL AT BASE DRIP DETAIL (SECTION VIEW)	15	NOV 22
16/16	FLOOR TO FLOOR PANEL JOINT (PLAN & SECTION VIEW)	16	NOV 22

#### \* SOLID SHEET OPTIONS

- SOLID ALUMINIUM
- ALUCOLUX®
- PERFORATED ALUMINIUM
- STAINLESS STEEL
- COPPER
- SOLID ZINC

Cladding Type :

**ENCLAD™ SOLID SHEET \***

Support System :

**ENCLAD™ EN05-FF - HOOK ON SECRET FIXED**

Detail Description :

COVER PAGE

Scale @ A3 :

Rev. : NOV 2022

System # :

SS-EN05-FF-HOP-SF2

Detail # :

00

**ENCLAD™ RAINSCREEN SYSTEMS**

EN05 - FF - ADJUSTABLE SYSTEM CAVITY

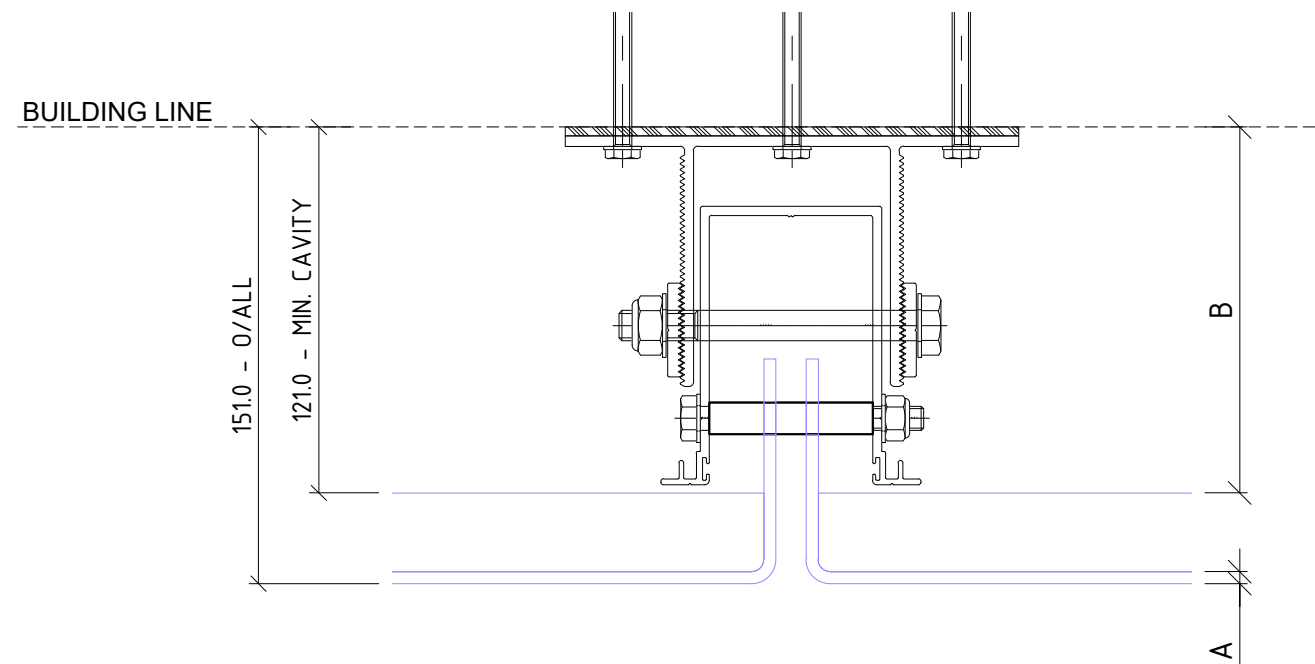

EN05 - FF  
MINIMUM SYSTEM CAVITY 121mm

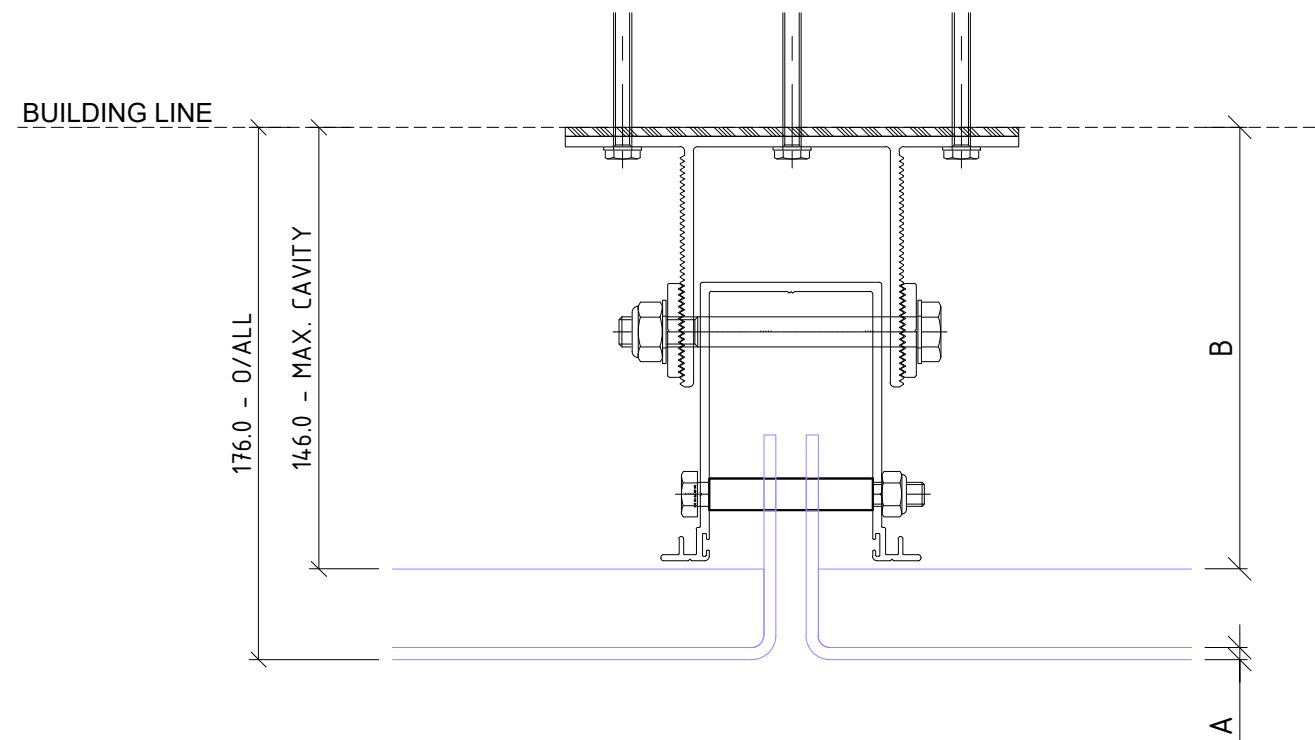

EN05 - FF  
MAXIMUM SYSTEM CAVITY 146mm

01 CAVITY SET OUT  
ENCLAD™ SOLID SHEET \*

ADJUSTABLE SYSTEMS ACCOMODATE BUILDING TOLERANCE AND INCORPORATION OF INSULATION FOR H1 REQUIREMENTS - STANDARD SYSTEM CAVITY SHOWN - BESPOKE OPTIONS AVAILABLE FOR PROJECT SPECIFIC REQUIREMENTS

PART OF THE THERMOSASH GROUP COMPANIES :



**COPYRIGHT :** THESE DESIGNS, DETAILS AND/OR SPECIFICATIONS AND THE COPYRIGHT THEREIN, REMAIN THE PROPERTY OF INSITE FACADES LTD.

**DISCLAIMER :** THESE DETAILS ARE PROVIDED FOR INDICATIVE PURPOSES ONLY. CONSTRUCTION/SYSTEM DETAILS CAN VARY DEPENDING ON PROJECT SPECIFIC SPECIFICATION AND ENGINEERING REQUIREMENTS. THE DESIGNER IS RESPONSIBLE FOR ENSURING DETAILS SATISFY ALL NEW ZEALAND BUILDING CODE CLAUSES. THE DESIGNER IS RESPONSIBLE FOR ENSURING BUILDING WRAPS, FIRESTOPS AND INSULATION/SPECIFICATION COMPLY WITH MANUFACTURERS RECOMMENDATIONS AND NZBC REGULATIONS. REFER TO INSITE WEBSITE FOR FULL TERMS AND CONDITIONS.

**LEGEND**

A	ENCLAD™ SOLID SHEET *
B	* SYSTEM CAVITY (121mm MIN. - 146mm MAX.)
*	OTHER OPTIONS AVAILABLE (PROJECT SPECIFIC)

**\* SOLID SHEET OPTIONS**

•	SOLID ALUMINIUM
•	ALUCOLUX®
•	PERFORATED ALUMINIUM
•	STAINLESS STEEL
•	COPPER
•	SOLID ZINC

Cladding Type :

**ENCLAD™ SOLID SHEET \***

Support System :

**ENCLAD™ EN05-FF - HOOK ON SECRET FIXED**

Detail Description :

CAVITY SETOUT (PLAN VIEW)

Scale @ A3 : 1:2.5

Rev. : NOV 2022

System # :

SS-EN05-FF-HOP-SF2

Detail # :

01

**ENCLAD™ RAINSCREEN SYSTEMS**



101 STATION ROAD, PENROSE,  
AUCKLAND 1061  
NEW ZEALAND

P: +64 9 307 1529  
www.insitefacades.co.nz

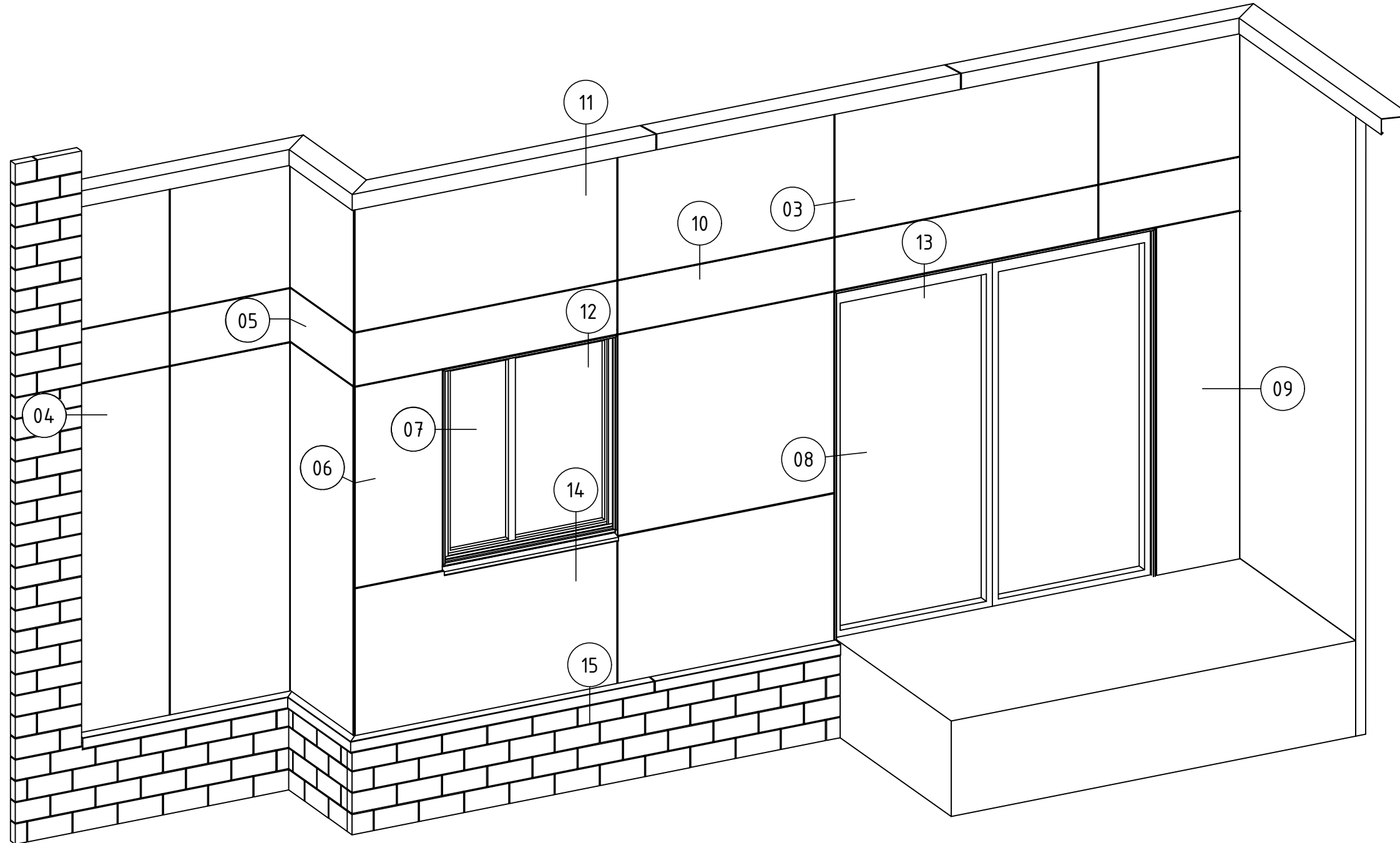

**\* SOLID SHEET OPTIONS**

•	SOLID ALUMINIUM
•	ALUCOLUX®
•	PERFORATED ALUMINIUM
•	STAINLESS STEEL
•	COPPER
•	SOLID ZINC

Cladding Type :

**ENCLAD™ SOLID SHEET \***

Support System :

**ENCLAD™ EN05-FF - HOOK ON SECRET FIXED**

Detail Description :

SCHEMATIC

Scale @ A3 : 1:5

Rev. : NOV 2022

System # :

SS-EN05-FF-HOP-SF2

Detail # :

02

**ENCLAD™ RAINSCREEN SYSTEMS**

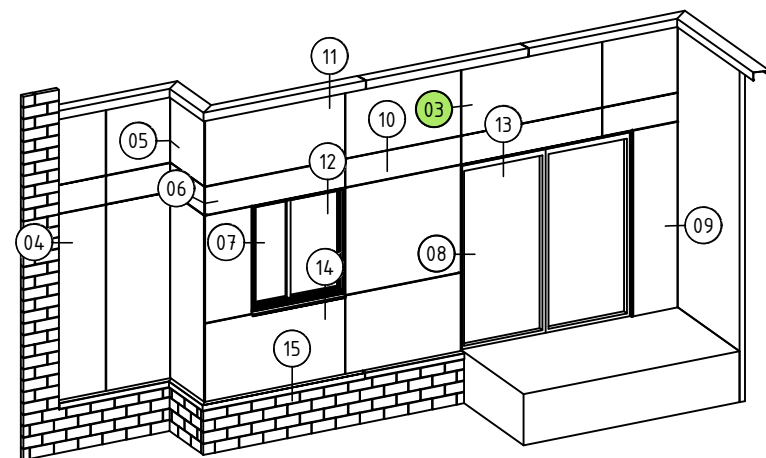
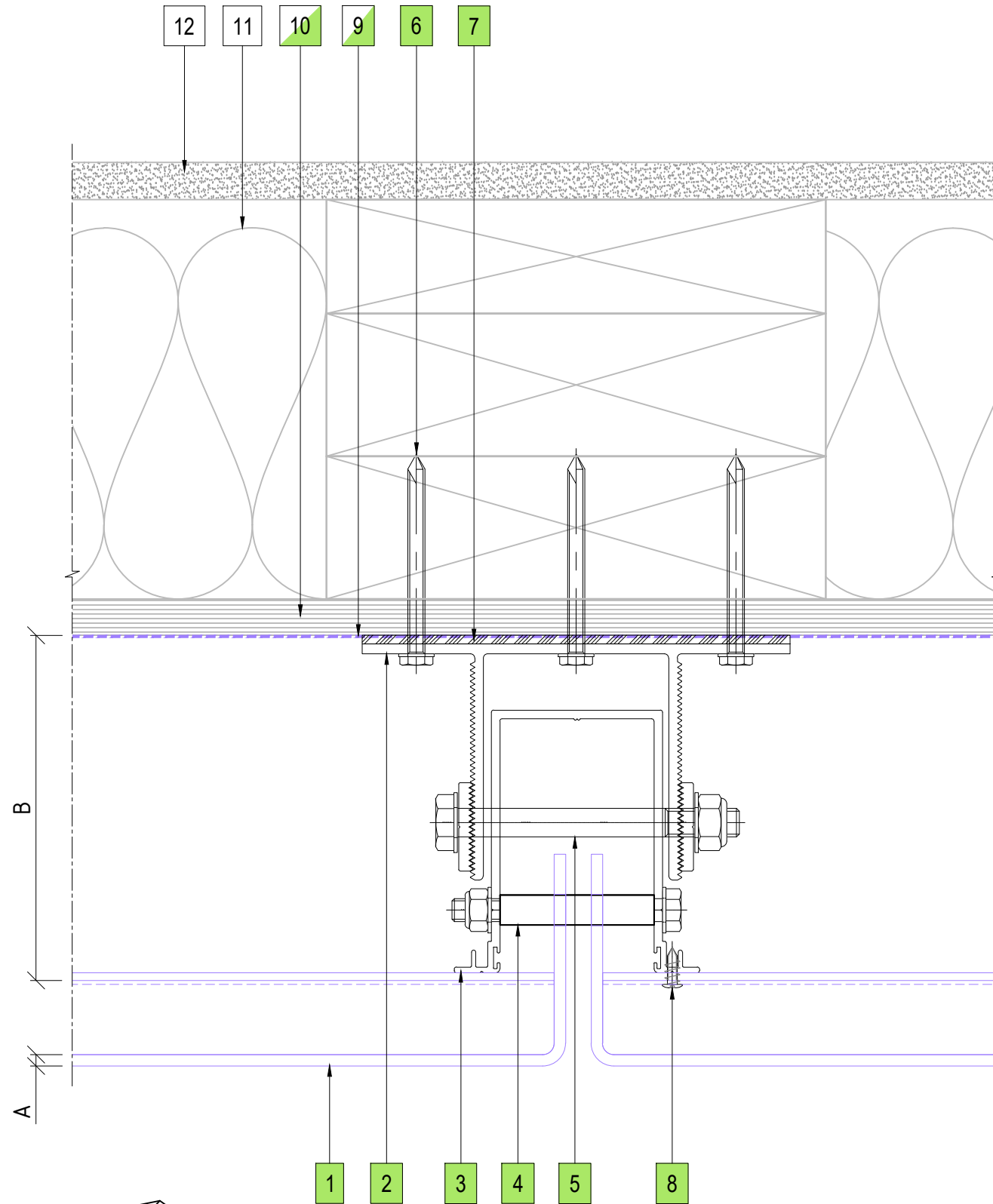

03 VERTICAL PANEL JOINT DETAIL  
ENCLAD™ SOLID SHEET \*

PART OF THE THERMOSASH GROUP COMPANIES :



**COPYRIGHT :** THESE DESIGNS, DETAILS AND/OR SPECIFICATIONS AND THE COPYRIGHT THEREIN, REMAIN THE PROPERTY OF INSITE FACADES LTD.

**DISCLAIMER :** THESE DETAILS ARE PROVIDED FOR INDICATIVE PURPOSES ONLY. CONSTRUCTION/SYSTEM DETAILS CAN VARY DEPENDING ON PROJECT SPECIFIC SPECIFICATION AND ENGINEERING REQUIREMENTS. THE DESIGNER IS RESPONSIBLE FOR ENSURING DETAILS SATISFY ALL NEW ZEALAND BUILDING CODE CLAUSES. THE DESIGNER IS RESPONSIBLE FOR ENSURING BUILDING WRAPS, FIRESTOPS AND INSULATION/SPECIFICATION COMPLY WITH MANUFACTURERS RECOMMENDATIONS AND NZBC REGULATIONS. REFER TO INSITE WEBSITE FOR FULL TERMS AND CONDITIONS.

**LEGEND**

A	ENCLAD™ SOLID SHEET *
B	* SYSTEM CAVITY (121mm MIN. - 146mm MAX.)
*	OTHER OPTIONS AVAILABLE (PROJECT SPECIFIC)

**PARTS LIST**

1	ENCLAD™ SOLID SHEET *
2	ENCLAD EN01 ALUMINIUM STRONG BACK PROFILE
3	ENCLAD EN01 ALUMINIUM CHANNEL PROFILE
4	ENCLAD FIXING FOR HOOK (STAINLESS STEEL)
5	ENCLAD FIXING FOR CHANNEL PROFILE (STAINLESS STEEL)
6	ENCLAD HOST STRUCTURAL FIXING (STAINLESS STEEL)
7	ENCLAD THERMAL ISOLATION PAD
8	ENCLAD PANEL FIXING (STAINLESS STEEL)
9	BUILDING WRAP / MEMBRANE (OPTION BY INSITE)
10	RIGID AIR BARRIER / SHEATHING BOARD (OPTION BY INSITE)
11	WALL INSULATION (BY OTHERS)
12	PLASTER BOARD (BY OTHERS)

**\* SOLID SHEET OPTIONS**

•	SOLID ALUMINIUM
•	ALUCOLUX®
•	PERFORATED ALUMINIUM
•	STAINLESS STEEL
•	COPPER
•	SOLID ZINC

Cladding Type :

**ENCLAD™ SOLID SHEET \***

Support System :

**ENCLAD™ EN05-FF - HOOK ON SECRET FIXED**

Detail Description :

VERTICAL PANEL JOINT DETAIL(PLAN VIEW)

Scale @ A3 : 1:2

Rev. : NOV 2022

System # :

SS-EN05-FF-HOP-SF2

Detail # :

03

**ENCLAD™ RAINSCREEN SYSTEMS**



101 STATION ROAD, PENROSE,  
AUCKLAND 1061  
NEW ZEALAND

P: +64 9 307 1529  
www.insitefacades.co.nz

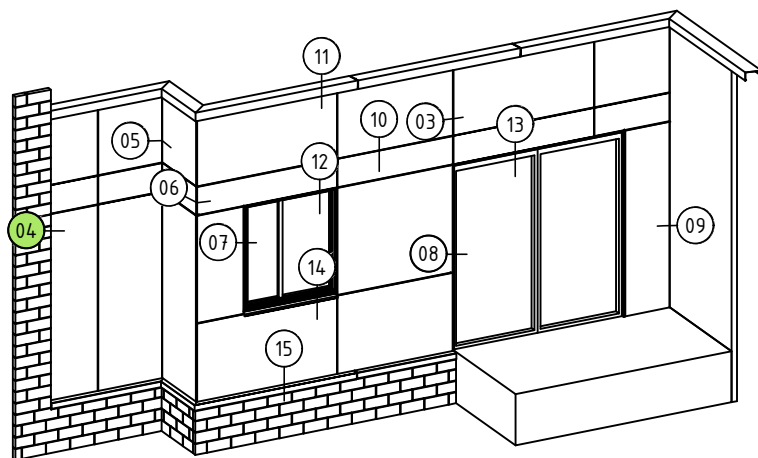
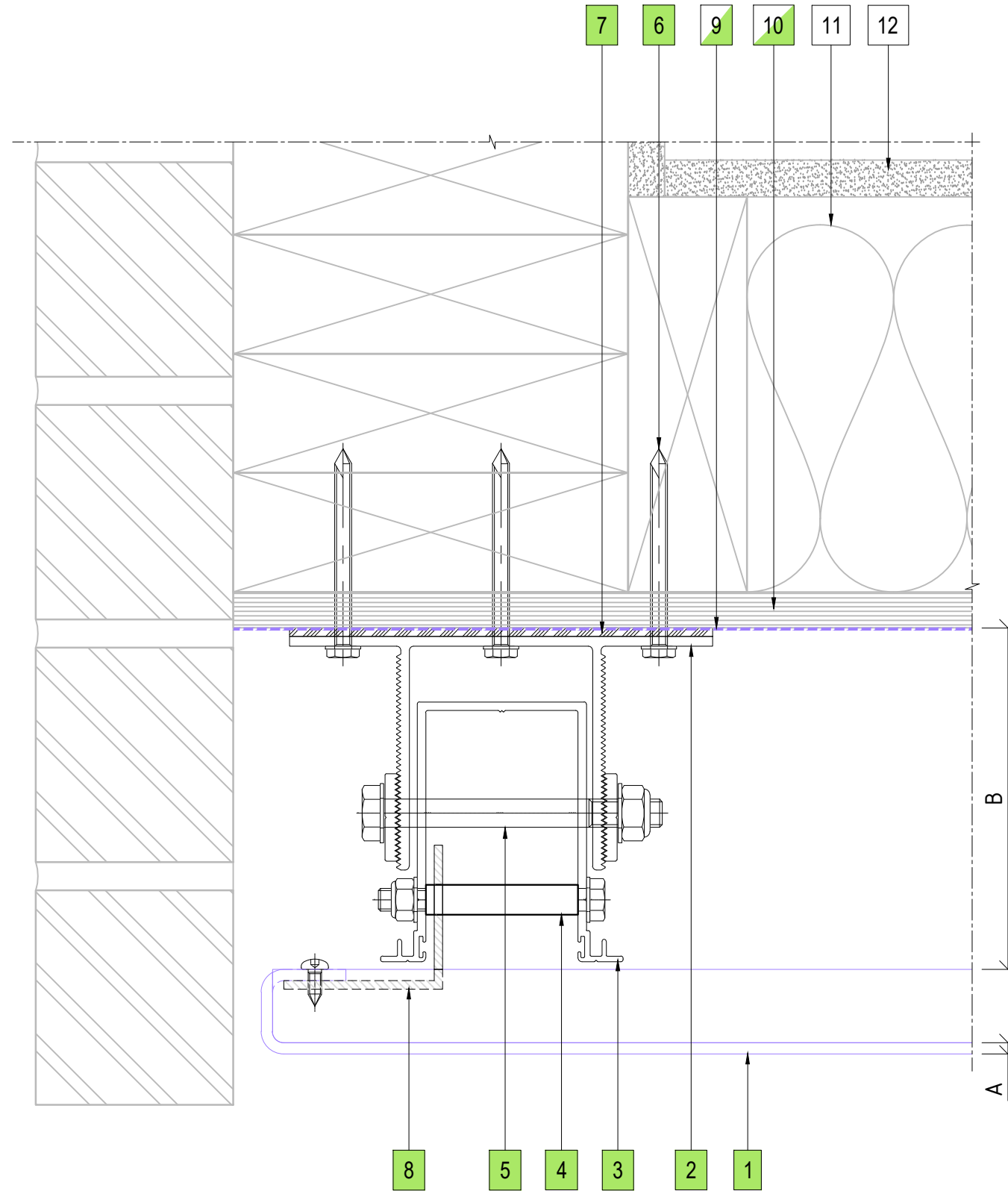

04 BRICKWALL ABUTMENT DETAIL  
ENCLAD™ SOLID SHEET \*

**LEGEND**

A	ENCLAD™ SOLID SHEET *
B	* SYSTEM CAVITY (121mm MIN. - 146mm MAX.)
*	OTHER OPTIONS AVAILABLE (PROJECT SPECIFIC)

**PARTS LIST**

1	ENCLAD™ SOLID SHEET *
2	ENCLAD EN01 ALUMINIUM STRONG BACK PROFILE
3	ENCLAD EN01 ALUMINIUM CHANNEL PROFILE
4	ENCLAD FIXING FOR HOOK (STAINLESS STEEL)
5	ENCLAD FIXING FOR CHANNEL PROFILE (STAINLESS STEEL)
6	ENCLAD HOST STRUCTURAL FIXING (STAINLESS STEEL)
7	ENCLAD THERMAL ISOLATION PAD
8	ENCLAD ALUMINIUM ANGLE FOR HOOK
9	BUILDING WRAP / MEMBRANE (OPTION BY INSITE)
10	RIGID AIR BARRIER / SHEATHING BOARD (OPTION BY INSITE)
11	WALL INSULATION (BY OTHERS)
12	PLASTER BOARD (BY OTHERS)

**\* SOLID SHEET OPTIONS**

•	SOLID ALUMINIUM
•	ALUCOLUX®
•	PERFORATED ALUMINIUM
•	STAINLESS STEEL
•	COPPER
•	SOLID ZINC

Cladding Type :

**ENCLAD™ SOLID SHEET \***

Support System :

**ENCLAD™ EN05-FF - HOOK ON SECRET FIXED**

Detail Description :

**BRICKWALL ABUTMENT DETAIL(PLAN VIEW)**

Scale @ A3 : 1:2

Rev. : NOV 2022

System # :

**SS-EN05-FF-HOP-SF2**

Detail # :

**04**

**ENCLAD™ RAINSCREEN SYSTEMS**

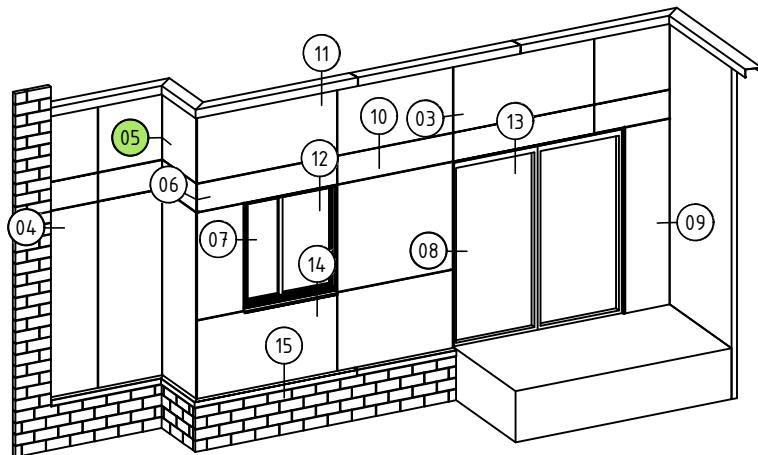
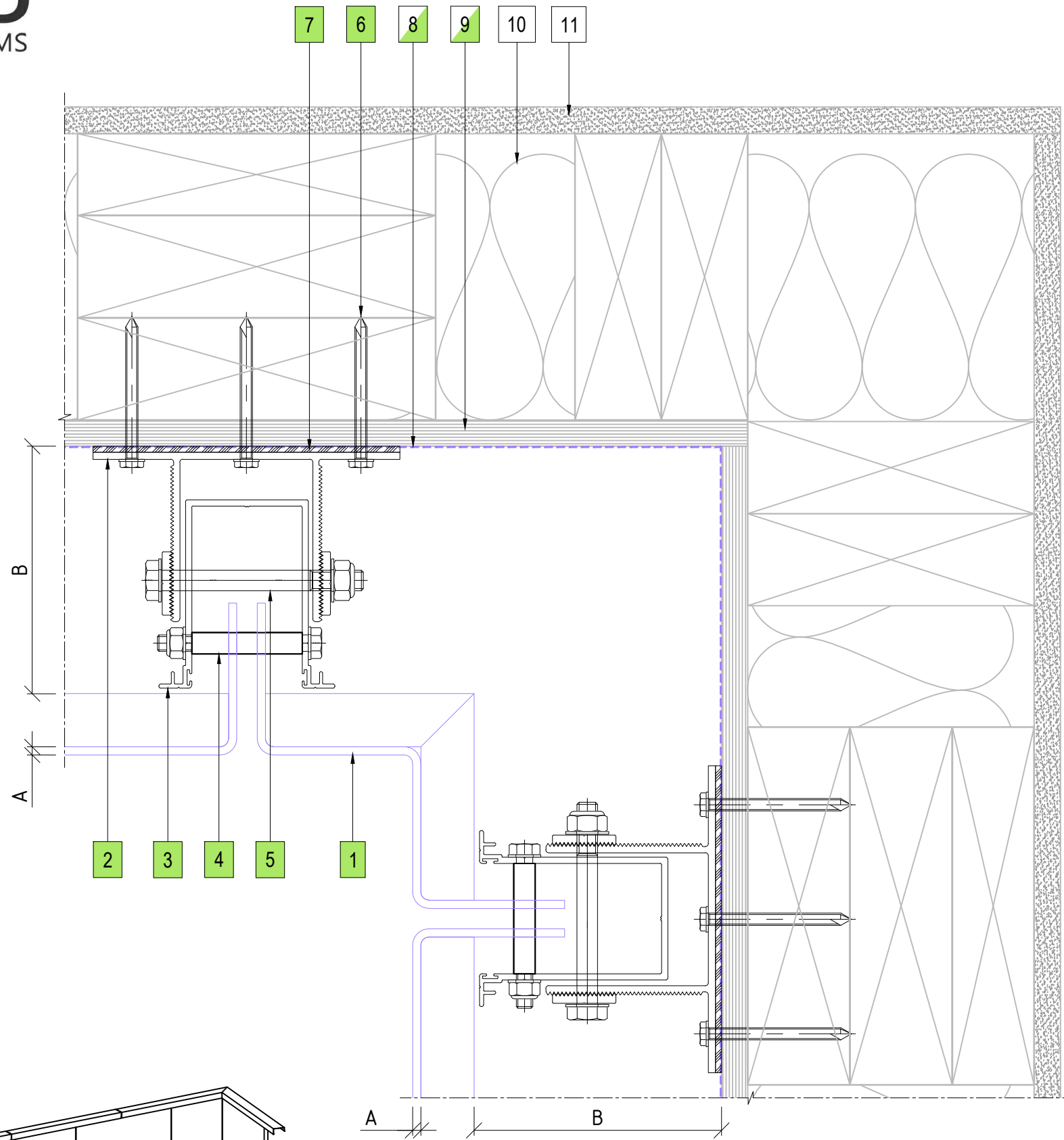

05 BRICKWALL ABUTMENT DETAIL  
ENCLAD™ SOLID SHEET \*

**COPYRIGHT :** THESE DESIGNS, DETAILS AND/OR SPECIFICATIONS AND THE COPYRIGHT THEREIN, REMAIN THE PROPERTY OF INSITE FACADES LTD.

**DISCLAIMER :** THESE DETAILS ARE PROVIDED FOR INDICATIVE PURPOSES ONLY. CONSTRUCTION/SYSTEM DETAILS CAN VARY DEPENDING ON PROJECT SPECIFIC SPECIFICATION AND ENGINEERING REQUIREMENTS. THE DESIGNER IS RESPONSIBLE FOR ENSURING DETAILS SATISFY ALL NEW ZEALAND BUILDING CODE CLAUSES. THE DESIGNER IS RESPONSIBLE FOR ENSURING BUILDING WRAPS, FIRESTOPS AND INSULATION/SPECIFICATION COMPLY WITH MANUFACTURERS RECOMMENDATIONS AND NZBC REGULATIONS. REFER TO INSITE WEBSITE FOR FULL TERMS AND CONDITIONS.

**LEGEND**

A	ENCLAD™ SOLID SHEET *
B	* SYSTEM CAVITY (121mm MIN. - 146mm MAX.)
*	OTHER OPTIONS AVAILABLE (PROJECT SPECIFIC)

**PARTS LIST**

1	ENCLAD™ SOLID SHEET *
2	ENCLAD EN01 ALUMINIUM STRONG BACK PROFILE
3	ENCLAD EN01 ALUMINIUM CHANNEL PROFILE
4	ENCLAD FIXING FOR HOOK (STAINLESS STEEL)
5	ENCLAD FIXING FOR CHANNEL PROFILE (STAINLESS STEEL)
6	ENCLAD HOST STRUCTURAL FIXING (STAINLESS STEEL)
7	ENCLAD THERMAL ISOLATION PAD
8	BUILDING WRAP / MEMBRANE (OPTION BY INSITE)
9	RIGID AIR BARRIER / SHEATHING BOARD (OPTION BY INSITE)
10	WALL INSULATION (BY OTHERS)
11	PLASTER BOARD (BY OTHERS)

**\* SOLID SHEET OPTIONS**

•	SOLID ALUMINIUM
•	ALUCOLUX®
•	PERFORATED ALUMINIUM
•	STAINLESS STEEL
•	COPPER
•	SOLID ZINC

Cladding Type :

**ENCLAD™ SOLID SHEET \***

Support System :

**ENCLAD™ EN05-FF - HOOK ON SECRET FIXED**

Detail Description :

**BRICKWALL ABUTMENT DETAIL(PLAN VIEW)**

Scale @ A3 : 1:2.5

Rev. : NOV 2022

System # :

**SS-EN05-FF-HOP-SF2**

Detail # :

**05**

**ENCLAD™ RAINSCREEN SYSTEMS**

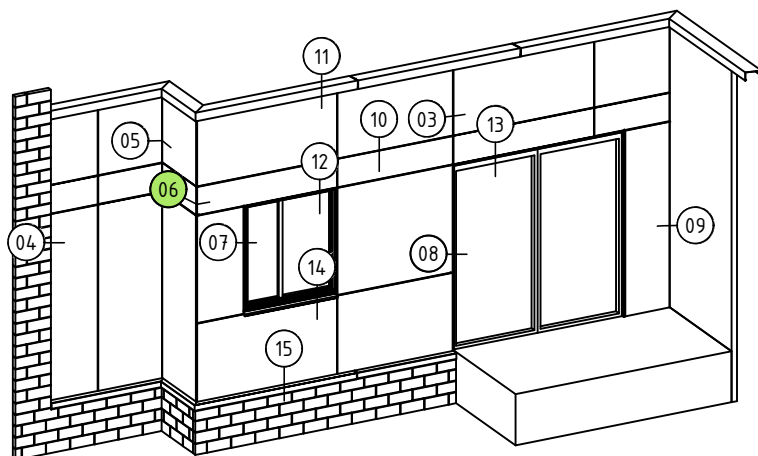
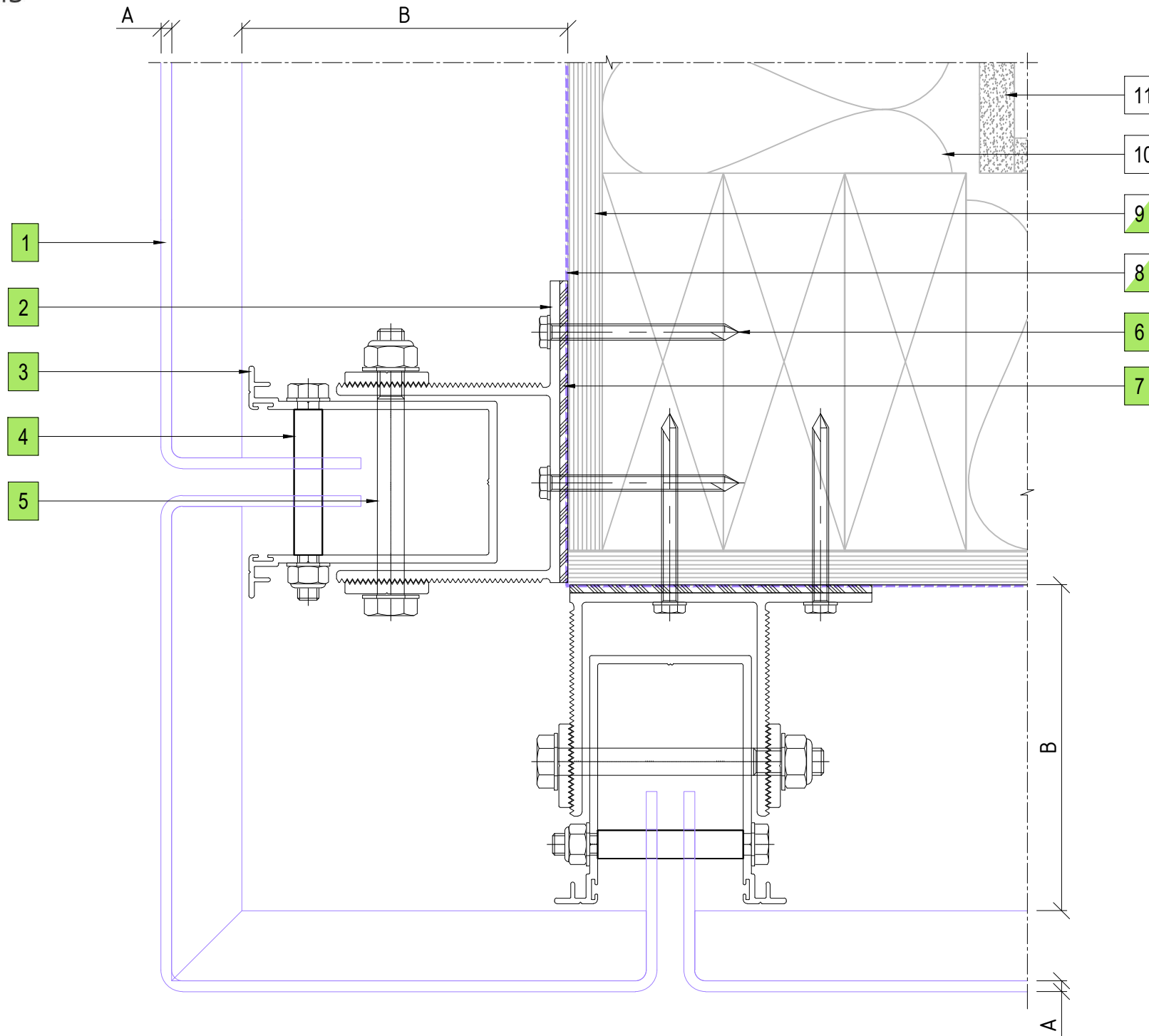

06 EXTERNAL CORNER PANEL DETAIL  
ENCLAD™ SOLID SHEET \*

**LEGEND**

A	ENCLAD™ SOLID SHEET *
B	* SYSTEM CAVITY (121mm MIN. - 146mm MAX.)
*	OTHER OPTIONS AVAILABLE (PROJECT SPECIFIC)

**PARTS LIST**

1	ENCLAD™ SOLID SHEET *
2	ENCLAD EN01 ALUMINIUM STRONG BACK PROFILE
3	ENCLAD EN01 ALUMINIUM CHANNEL PROFILE
4	ENCLAD FIXING FOR HOOK (STAINLESS STEEL)
5	ENCLAD FIXING FOR CHANNEL PROFILE (STAINLESS STEEL)
6	ENCLAD HOST STRUCTURAL FIXING (STAINLESS STEEL)
7	ENCLAD THERMAL ISOLATION PAD
8	BUILDING WRAP / MEMBRANE (OPTION BY INSITE)
9	RIGID AIR BARRIER / SHEATHING BOARD (OPTION BY INSITE)
10	WALL INSULATION (BY OTHERS)
11	PLASTER BOARD (BY OTHERS)

**\* SOLID SHEET OPTIONS**

•	SOLID ALUMINIUM
•	ALUCOLUX®
•	PERFORATED ALUMINIUM
•	STAINLESS STEEL
•	COPPER
•	SOLID ZINC

Cladding Type :

**ENCLAD™ SOLID SHEET \***

Support System :

**ENCLAD™ EN05-FF - HOOK ON SECRET FIXED**

Detail Description :

EXTERNAL CORNER PANEL DETAIL(PLAN VIEW)

Scale @ A3 : 1:2

Rev. : NOV 2022

System # :

SS-EN05-FF-HOP-SF2

Detail # :

06

**ENCLAD™ RAINSCREEN SYSTEMS**

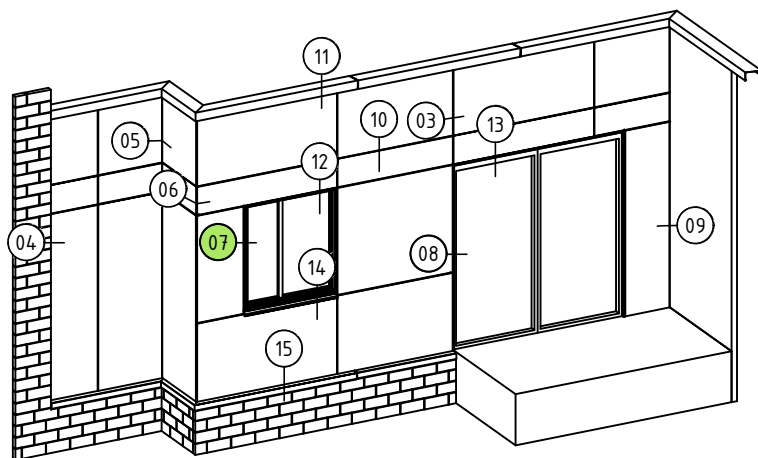
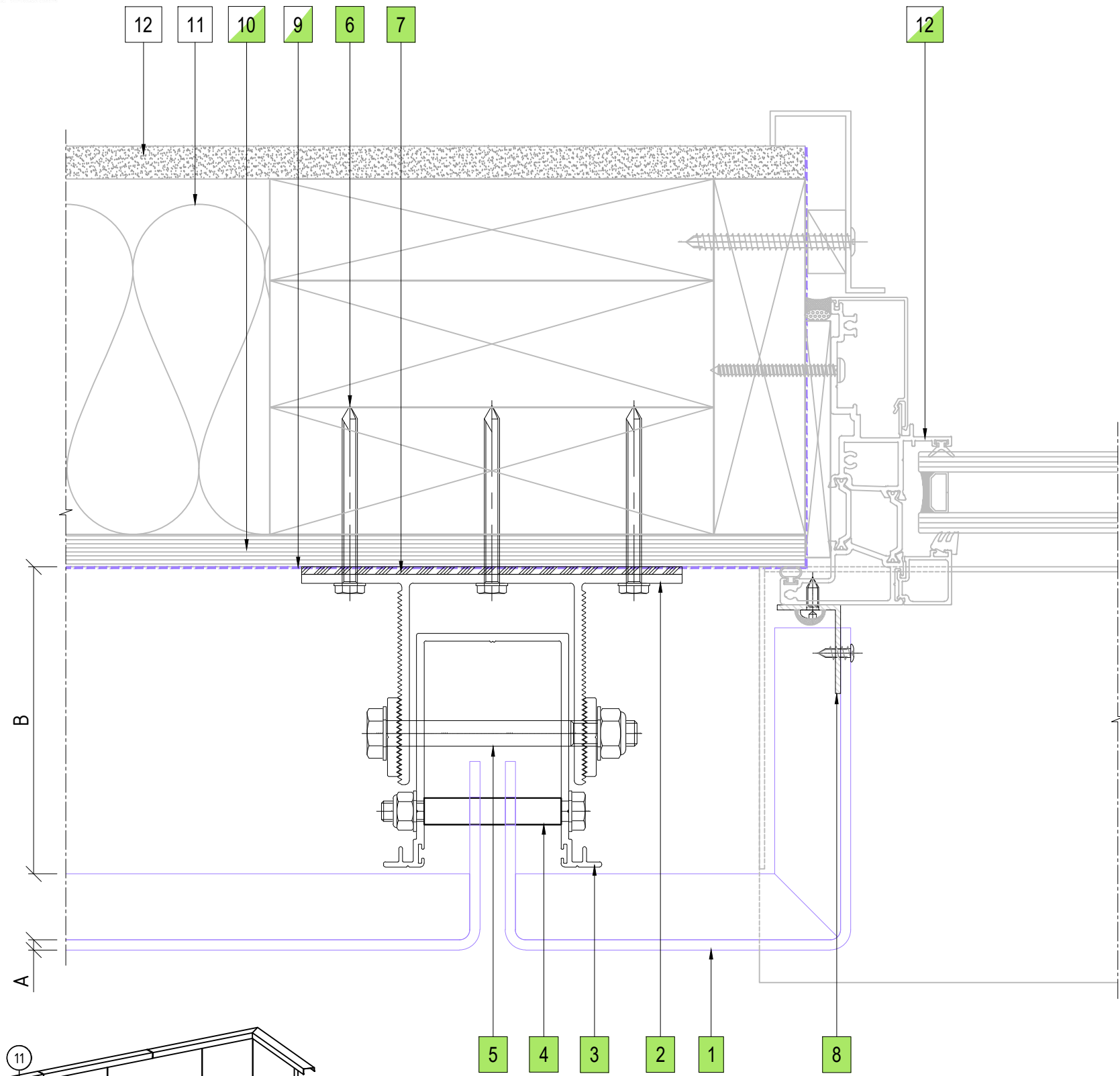

07 WINDOW JAMB DETAIL  
ENCLAD™ SOLID SHEET \*

**LEGEND**

A	ENCLAD™ SOLID SHEET *
B	* SYSTEM CAVITY (121mm MIN. - 146mm MAX.)
*	OTHER OPTIONS AVAILABLE (PROJECT SPECIFIC)

**PARTS LIST**

1	ENCLAD™ SOLID SHEET *
2	ENCLAD EN01 ALUMINIUM STRONG BACK PROFILE
3	ENCLAD EN01 ALUMINIUM CHANNEL PROFILE
4	ENCLAD FIXING FOR HOOK (STAINLESS STEEL)
5	ENCLAD FIXING FOR CHANNEL PROFILE (STAINLESS STEEL)
6	ENCLAD HOST STRUCTURAL FIXING (STAINLESS STEEL)
7	ENCLAD THERMAL ISOLATION PAD
8	ENCLAD ALUMINIUM CLOSURE
9	BUILDING WRAP / MEMBRANE (OPTION BY INSITE)
10	RIGID AIR BARRIER / SHEATHING BOARD (OPTION BY INSITE)
11	ALUMINIUM DOORS, WINDOWS & REVEALS (OPTION BY INSITE)
12	WALL INSULATION (BY OTHERS)
13	PLASTER BOARD (BY OTHERS)

**\* SOLID SHEET OPTIONS**

•	SOLID ALUMINIUM
•	ALUCOLUX®
•	PERFORATED ALUMINIUM
•	STAINLESS STEEL
•	COPPER
•	SOLID ZINC

Cladding Type :

**ENCLAD™ SOLID SHEET \***

Support System :

**ENCLAD™ EN05-FF - HOOK ON SECRET FIXED**

Detail Description :

**VERTICAL PANEL JOINT DETAIL(PLAN VIEW)**

Scale @ A3 : 1:2

Rev. : NOV 2022

System # :

**SS-EN05-FF-HOP-SF2**

Detail # :

**07**

**ENCLAD™ RAINSCREEN SYSTEMS**



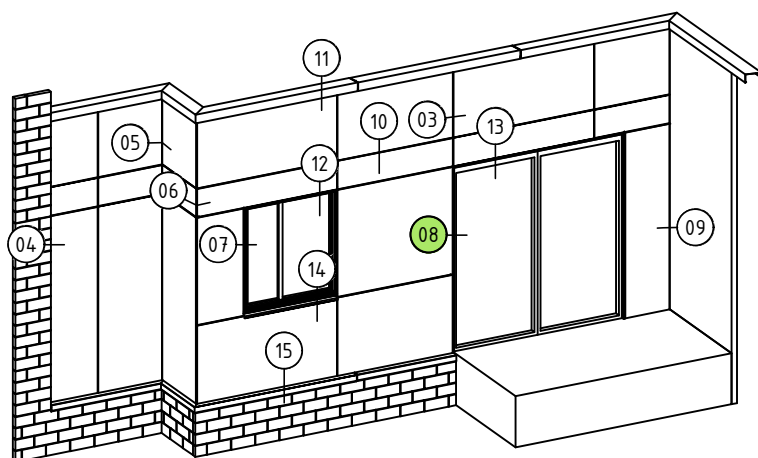
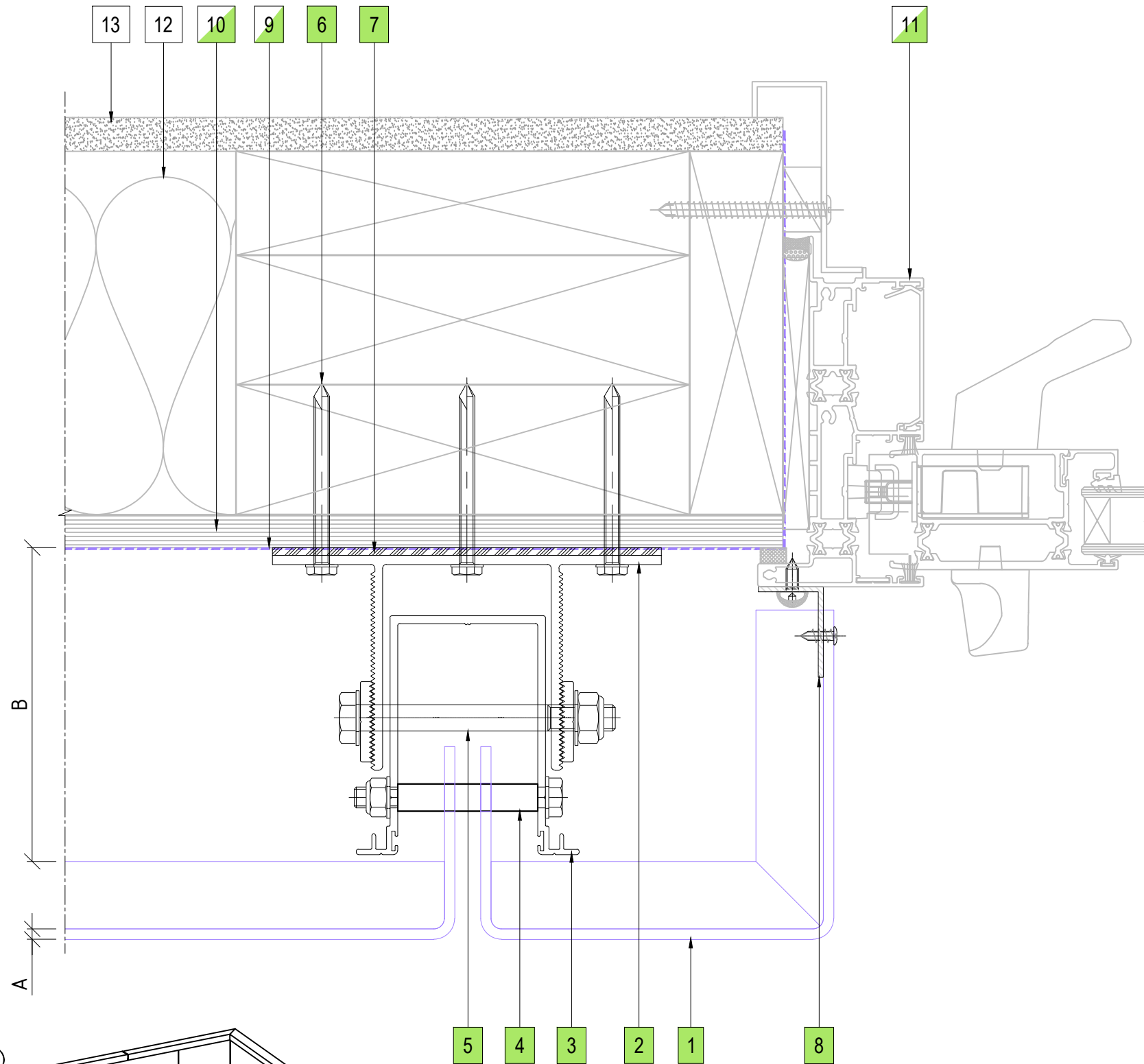

08 DOOR JAMB DETAIL  
ENCLAD™ SOLID SHEET \*

**LEGEND**

A	ENCLAD™ SOLID SHEET *
B	* SYSTEM CAVITY (121mm MIN. - 146mm MAX.)
*	OTHER OPTIONS AVAILABLE (PROJECT SPECIFIC)

**PARTS LIST**

1	ENCLAD™ SOLID SHEET *
2	ENCLAD EN01 ALUMINIUM STRONG BACK PROFILE
3	ENCLAD EN01 ALUMINIUM CHANNEL PROFILE
4	ENCLAD FIXING FOR HOOK (STAINLESS STEEL)
5	ENCLAD FIXING FOR CHANNEL PROFILE (STAINLESS STEEL)
6	ENCLAD HOST STRUCTURAL FIXING (STAINLESS STEEL)
7	ENCLAD THERMAL ISOLATION PAD
8	ENCLAD ALUMINIUM CLOSURE
9	BUILDING WRAP / MEMBRANE (OPTION BY INSITE)
10	RIGID AIR BARRIER / SHEATHING BOARD (OPTION BY INSITE)
11	ALUMINIUM DOORS, WINDOWS & REVEALS (OPTION BY INSITE)
12	WALL INSULATION (BY OTHERS)
13	PLASTER BOARD (BY OTHERS)

**\* SOLID SHEET OPTIONS**

•	SOLID ALUMINIUM
•	ALUCOLUX®
•	PERFORATED ALUMINIUM
•	STAINLESS STEEL
•	COPPER
•	SOLID ZINC

Cladding Type :

**ENCLAD™ SOLID SHEET \***

Support System :

**ENCLAD™ EN05-FF - HOOK ON SECRET FIXED**

Detail Description :

EXTERNAL CORNER PANEL DETAIL(PLAN VIEW)

Scale @ A3 : 1:2

Rev. : NOV 2022

System # :

SS-EN05-FF-HOP-SF2

Detail # :

08

**ENCLAD™ RAINSCREEN SYSTEMS**

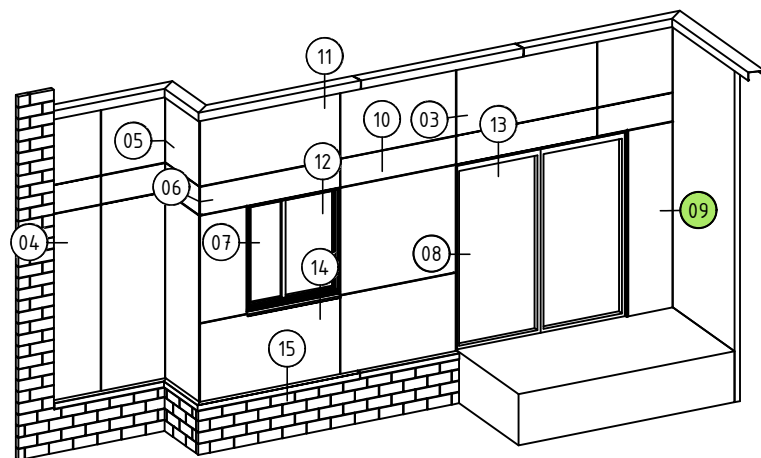
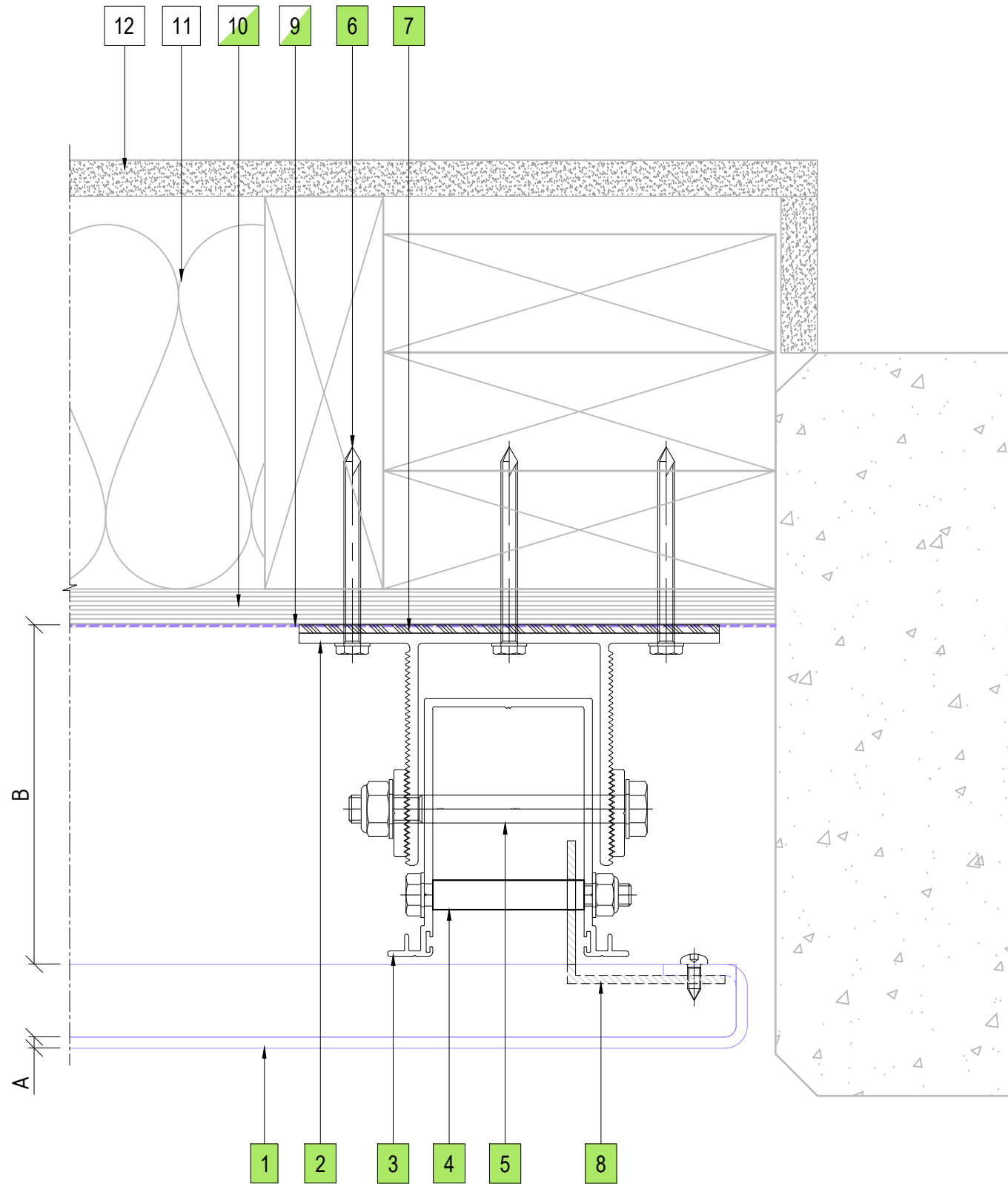

09 CONCRETE WALL ABUTMENT DETAIL  
ENCLAD™ SOLID SHEET \*

**LEGEND**

A	ENCLAD™ SOLID SHEET *
B	* SYSTEM CAVITY (121mm MIN. - 146mm MAX.)
*	OTHER OPTIONS AVAILABLE (PROJECT SPECIFIC)

**PARTS LIST**

1	ENCLAD™ SOLID SHEET *
2	ENCLAD EN01 ALUMINIUM STRONG BACK PROFILE
3	ENCLAD EN01 ALUMINIUM CHANNEL PROFILE
4	ENCLAD FIXING FOR HOOK (STAINLESS STEEL)
5	ENCLAD FIXING FOR CHANNEL PROFILE (STAINLESS STEEL)
6	ENCLAD HOST STRUCTURAL FIXING (STAINLESS STEEL)
7	ENCLAD THERMAL ISOLATION PAD
8	ENCLAD ALUMINIUM ANGLE FOR HOOK
9	BUILDING WRAP / MEMBRANE (OPTION BY INSITE)
10	RIGID AIR BARRIER / SHEATHING BOARD (OPTION BY INSITE)
11	WALL INSULATION (BY OTHERS)
12	PLASTER BOARD (BY OTHERS)

**\* SOLID SHEET OPTIONS**

•	SOLID ALUMINIUM
•	ALUCOLUX®
•	PERFORATED ALUMINIUM
•	STAINLESS STEEL
•	COPPER
•	SOLID ZINC

Cladding Type :

**ENCLAD™ SOLID SHEET \***

Support System :

**ENCLAD™ EN05-FF - HOOK ON SECRET FIXED**

Detail Description :

**CONCRETE WALL ABUTMENT DETAIL(PLAN VIEW)**

Scale @ A3 : 1:2

Rev. : NOV 2022

System # :

**SS-EN05-FF-HOP-SF2**

Detail # :

**09**

**ENCLAD™ RAINSCREEN SYSTEMS**

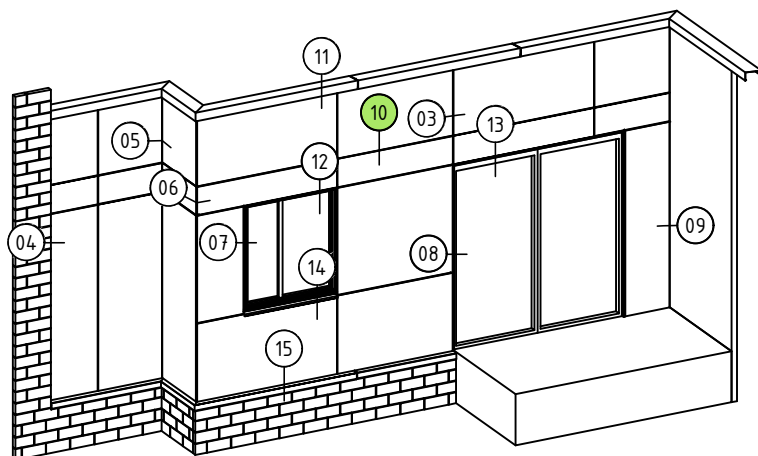
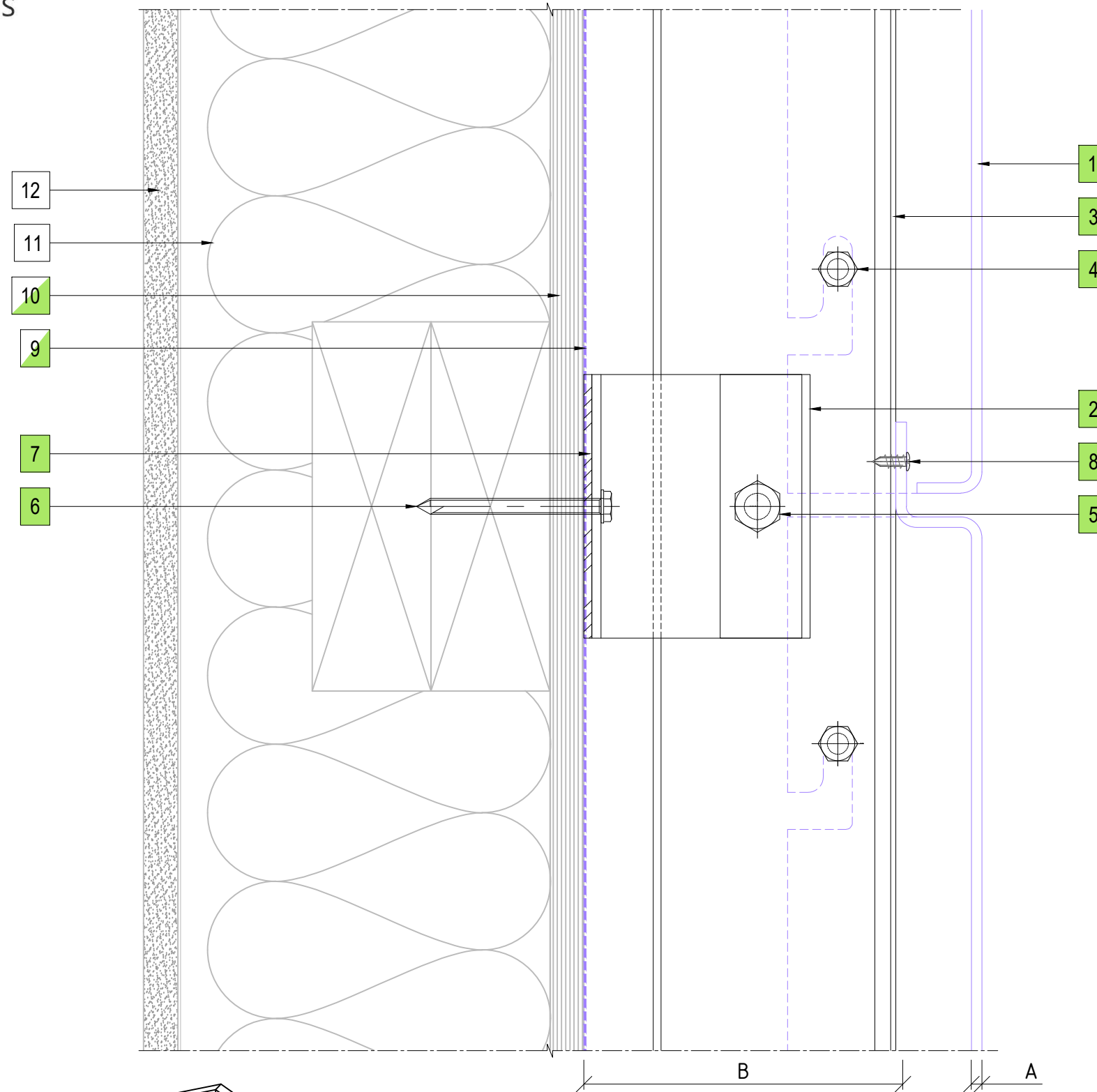

10 HORIZONTAL PANEL JOINT DETAIL  
ENCLAD™ SOLID SHEET \*

**LEGEND**

A	ENCLAD™ SOLID SHEET *
B	* SYSTEM CAVITY (121mm MIN. - 146mm MAX.)
*	OTHER OPTIONS AVAILABLE (PROJECT SPECIFIC)

**PARTS LIST**

1	ENCLAD™ SOLID SHEET *
2	ENCLAD EN01 ALUMINIUM STRONG BACK PROFILE
3	ENCLAD EN01 ALUMINIUM CHANNEL PROFILE
4	ENCLAD FIXING FOR HOOK (STAINLESS STEEL)
5	ENCLAD FIXING FOR CHANNEL PROFILE (STAINLESS STEEL)
6	ENCLAD HOST STRUCTURAL FIXING (STAINLESS STEEL)
7	ENCLAD THERMAL ISOLATION PAD
8	ENCLAD PANEL FIXING (STAINLESS STEEL)
9	BUILDING WRAP / MEMBRANE (OPTION BY INSITE)
10	RIGID AIR BARRIER / SHEATHING BOARD (OPTION BY INSITE)
11	WALL INSULATION (BY OTHERS)
12	PLASTER BOARD (BY OTHERS)

**\* SOLID SHEET OPTIONS**

•	SOLID ALUMINIUM
•	ALUCOLUX®
•	PERFORATED ALUMINIUM
•	STAINLESS STEEL
•	COPPER
•	SOLID ZINC

Cladding Type :

**ENCLAD™ SOLID SHEET \***

Support System :

**ENCLAD™ EN05-FF - HOOK ON SECRET FIXED**

Detail Description :

HORIZONTAL PANEL JOINT DETAIL (SECTION VIEW)

Scale @ A3 : 1:2

Rev. : NOV 2022

System # :

SS-EN05-FF-HOP-SF2

Detail # :

10

**ENCLAD™ RAINSCREEN SYSTEMS**

**LEGEND**

A	ENCLAD™ SOLID SHEET *
B	* SYSTEM CAVITY (121mm MIN. - 146mm MAX.)
*	OTHER OPTIONS AVAILABLE (PROJECT SPECIFIC)

**PARTS LIST**

1	ENCLAD™ SOLID SHEET *
2	ENCLAD EN01 ALUMINIUM STRONG BACK PROFILE
3	ENCLAD EN01 ALUMINIUM CHANNEL PROFILE
4	ENCLAD FIXING FOR HOOK (STAINLESS STEEL)
5	ENCLAD FIXING FOR CHANNEL PROFILE (STAINLESS STEEL)
6	ENCLAD HOST STRUCTURAL FIXING (STAINLESS STEEL)
7	ENCLAD THERMAL ISOLATION PAD
8	ENCLAD ALUMINIUM FLASHING
9	ENCLAD ALUMINIUM BRACKET
10	BUILDING WRAP / MEMBRANE (OPTION BY INSITE)
11	RIGID AIR BARRIER / SHEATHING BOARD (OPTION BY INSITE)
12	WALL INSULATION (BY OTHERS)
13	PLASTER BOARD (BY OTHERS)

**\* SOLID SHEET OPTIONS**

•	SOLID ALUMINIUM
•	ALUCOLUX®
•	PERFORATED ALUMINIUM
•	STAINLESS STEEL
•	COPPER
•	SOLID ZINC

Cladding Type :

**ENCLAD™ SOLID SHEET \***

Support System :

**ENCLAD™ EN05-FF - HOOK ON SECRET FIXED**

Detail Description :

**PARAPET FLASHING DETAIL(SECTION VIEW)**

Scale @ A3 : 1:2

Rev. : NOV 2022

System # :

**SS-EN05-FF-HOP-SF2**

Detail # :

**11**

**ENCLAD™ RAINSCREEN SYSTEMS**

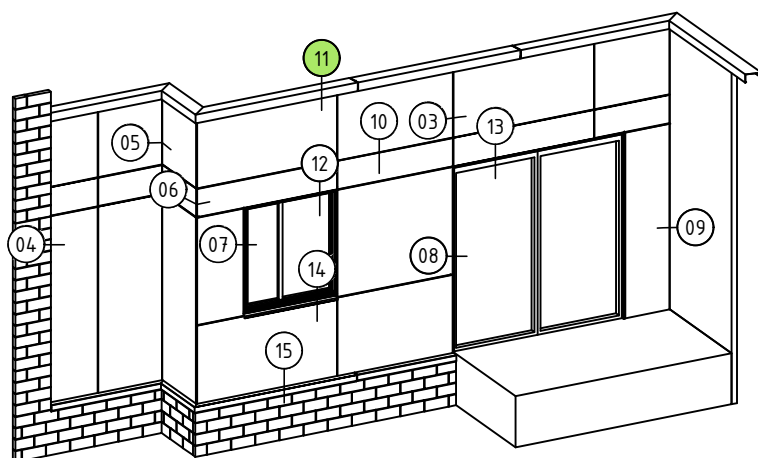
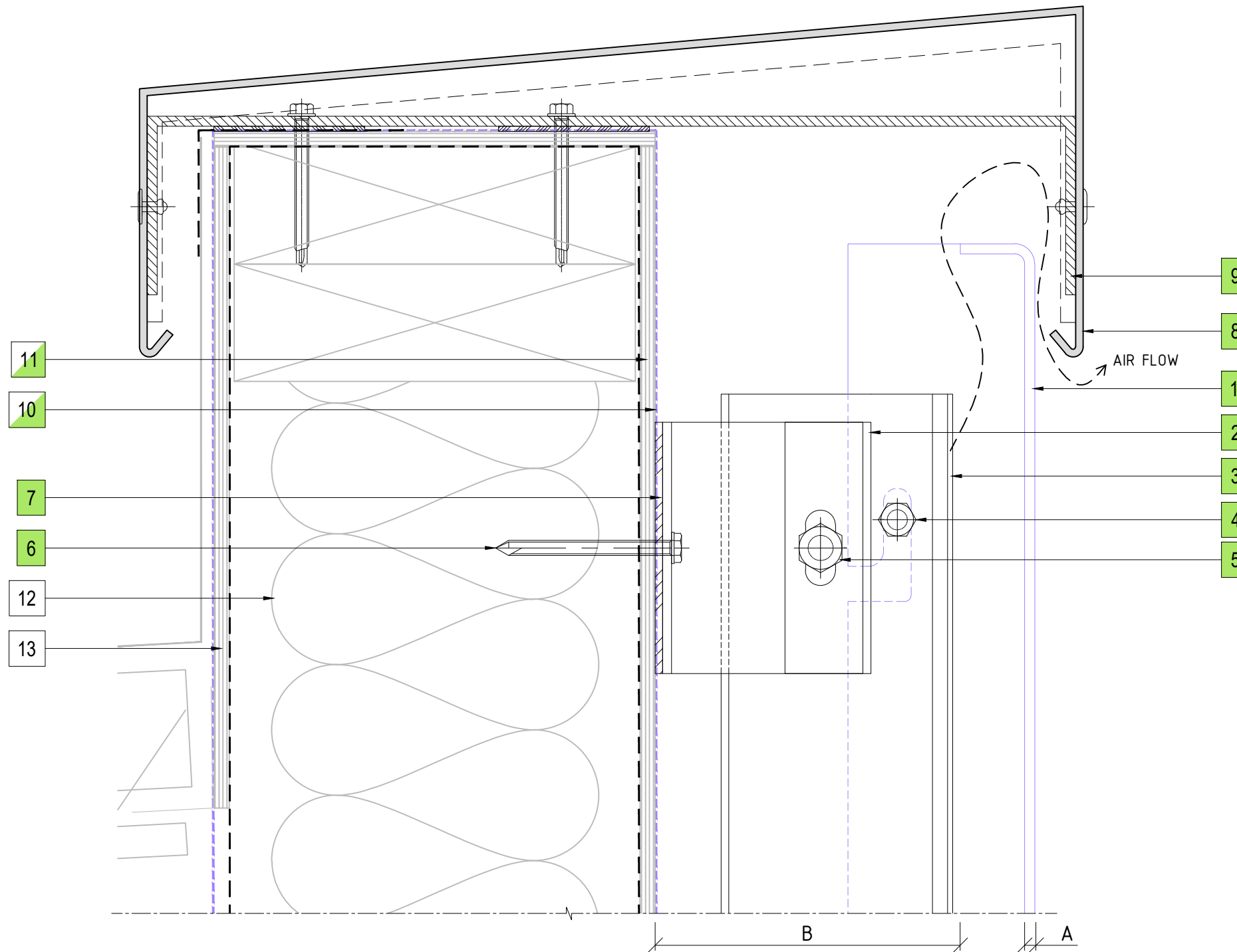

**11** PARAPET FLASHING DETAIL  
ENCLAD™ SOLID SHEET \*

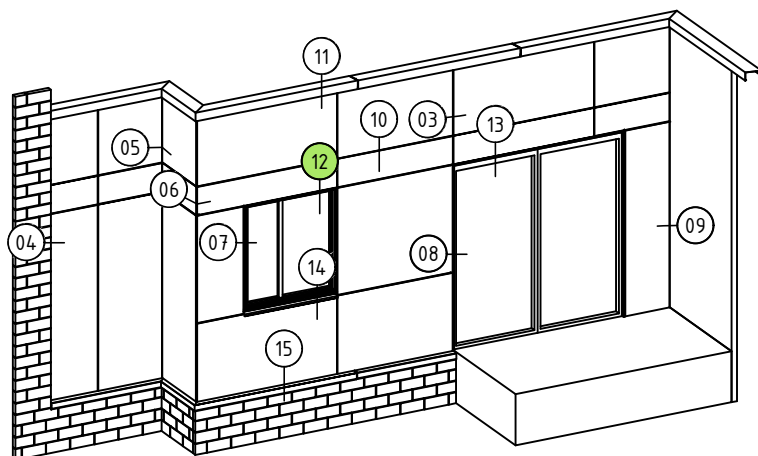
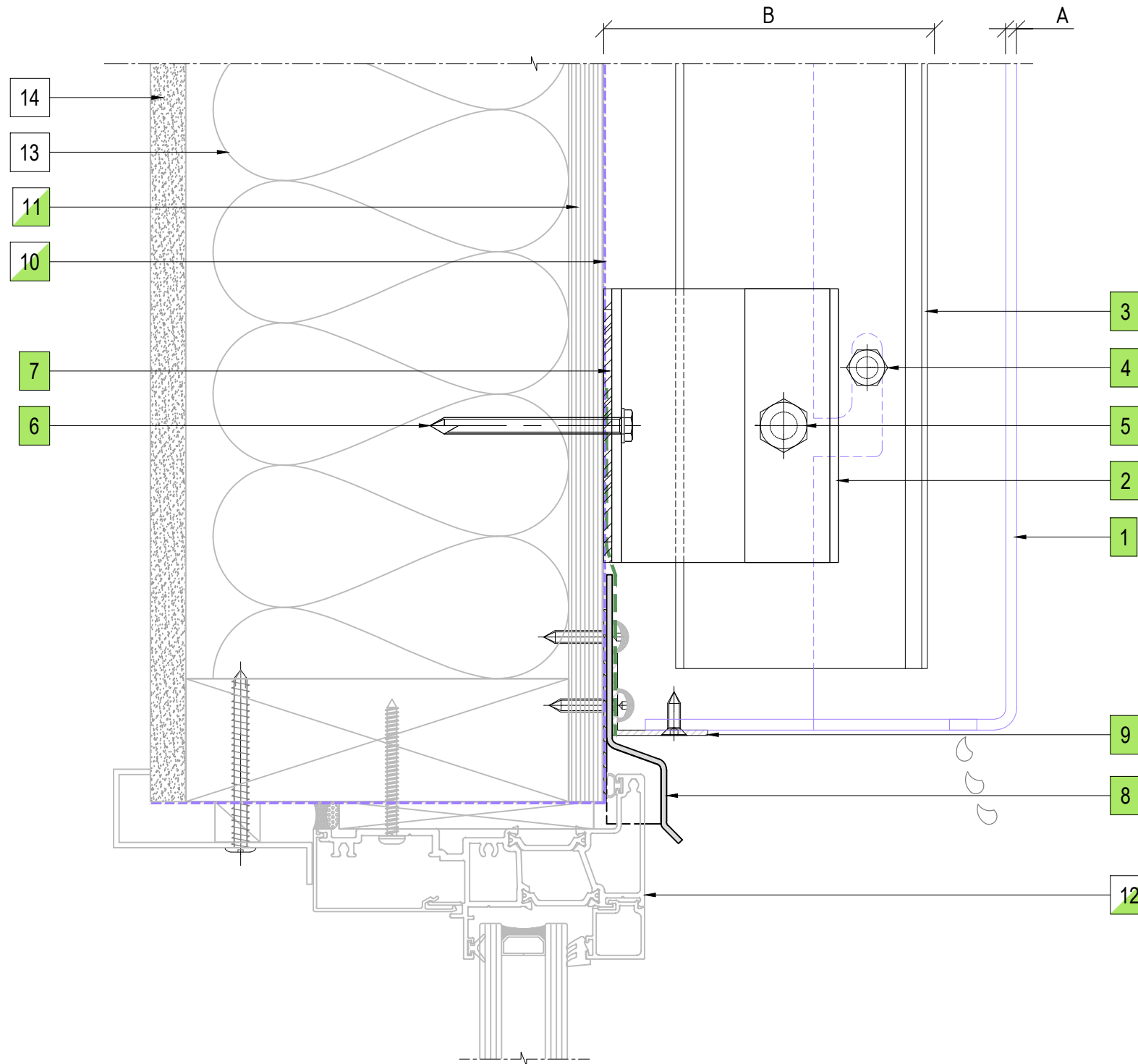

12 WINDOW JAMB DETAIL  
ENCLAD™ SOLID SHEET \*

**LEGEND**

A	ENCLAD™ SOLID SHEET *
B	* SYSTEM CAVITY (121mm MIN. - 146mm MAX.)
*	OTHER OPTIONS AVAILABLE (PROJECT SPECIFIC)

**PARTS LIST**

1	ENCLAD™ SOLID SHEET *
2	ENCLAD EN01 ALUMINIUM STRONG BACK PROFILE
3	ENCLAD EN01 ALUMINIUM CHANNEL PROFILE
4	ENCLAD FIXING FOR HOOK (STAINLESS STEEL)
5	ENCLAD FIXING FOR CHANNEL PROFILE (STAINLESS STEEL)
6	ENCLAD HOST STRUCTURAL FIXING (STAINLESS STEEL)
7	ENCLAD THERMAL ISOLATION PAD
8	ENCLAD ALUMINIUM FLASHING
9	ENCLAD ALUMINIUM CLOSURE
10	BUILDING WRAP / MEMBRANE (OPTION BY INSITE)
11	RIGID AIR BARRIER / SHEATHING BOARD (OPTION BY INSITE)
12	ALUMINIUM DOORS, WINDOWS & REVEALS (OPTION BY INSITE)
13	WALL INSULATION (BY OTHERS)
14	PLASTER BOARD (BY OTHERS)

**\* SOLID SHEET OPTIONS**

•	SOLID ALUMINIUM
•	ALUCOLUX®
•	PERFORATED ALUMINIUM
•	STAINLESS STEEL
•	COPPER
•	SOLID ZINC

Cladding Type :

**ENCLAD™ SOLID SHEET \***

Support System :

**ENCLAD™ EN05-FF - HOOK ON SECRET FIXED**

Detail Description :

WINDOW JAMB DETAIL (SECTION VIEW)

Scale @ A3 : 1:2

Rev. : NOV 2022

System # :

SS-EN05-FF-HOP-SF2

Detail # :

12

**ENCLAD™ RAINSCREEN SYSTEMS**

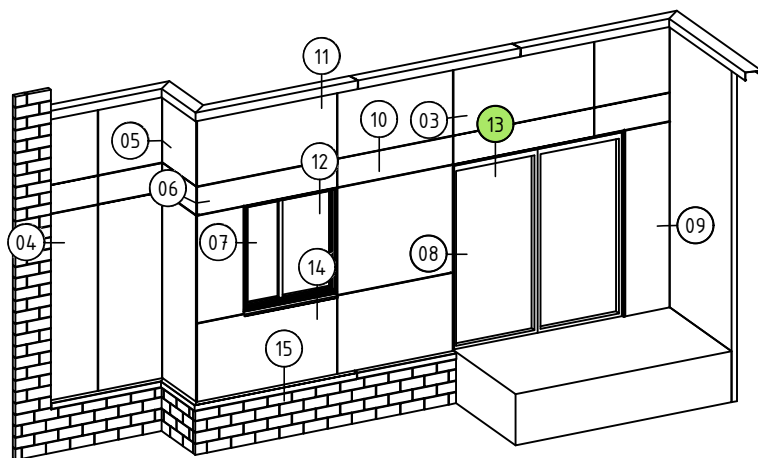
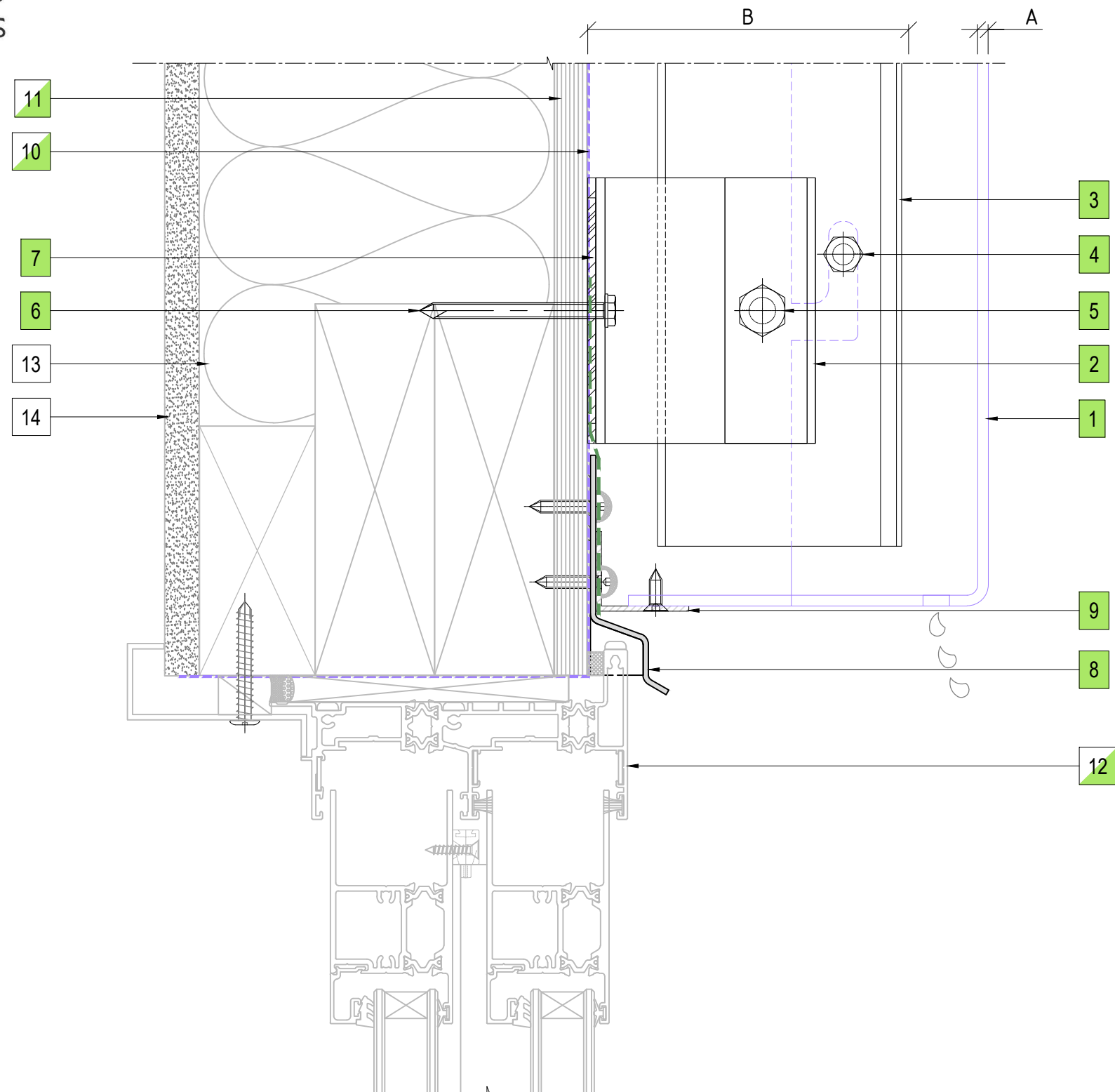

13 DOOR JAMB DETAIL  
ENCLAD™ SOLID SHEET \*

**COPYRIGHT :** THESE DESIGNS, DETAILS AND/OR SPECIFICATIONS AND THE COPYRIGHT THEREIN, REMAIN THE PROPERTY OF INSITE FACADES LTD.

**DISCLAIMER :** THESE DETAILS ARE PROVIDED FOR INDICATIVE PURPOSES ONLY. CONSTRUCTION/SYSTEM DETAILS CAN VARY DEPENDING ON PROJECT SPECIFIC SPECIFICATION AND ENGINEERING REQUIREMENTS. THE DESIGNER IS RESPONSIBLE FOR ENSURING DETAILS SATISFY ALL NEW ZEALAND BUILDING CODE CLAUSES. THE DESIGNER IS RESPONSIBLE FOR ENSURING BUILDING WRAPS, FIRESTOPS AND INSULATION/SPECIFICATION COMPLY WITH MANUFACTURERS RECOMMENDATIONS AND NZBC REGULATIONS. REFER TO INSITE WEBSITE FOR FULL TERMS AND CONDITIONS.

**LEGEND**

A	ENCLAD™ SOLID SHEET *
B	* SYSTEM CAVITY (121mm MIN. - 146mm MAX.)
*	OTHER OPTIONS AVAILABLE (PROJECT SPECIFIC)

**PARTS LIST**

1	ENCLAD™ SOLID SHEET *
2	ENCLAD EN01 ALUMINIUM STRONG BACK PROFILE
3	ENCLAD EN01 ALUMINIUM CHANNEL PROFILE
4	ENCLAD FIXING FOR HOOK (STAINLESS STEEL)
5	ENCLAD FIXING FOR CHANNEL PROFILE (STAINLESS STEEL)
6	ENCLAD HOST STRUCTURAL FIXING (STAINLESS STEEL)
7	ENCLAD THERMAL ISOLATION PAD
8	ENCLAD ALUMINIUM FLASHING
9	ENCLAD ALUMINIUM CLOSURE
10	BUILDING WRAP / MEMBRANE (OPTION BY INSITE)
11	RIGID AIR BARRIER / SHEATHING BOARD (OPTION BY INSITE)
12	ALUMINIUM DOORS, WINDOWS & REVEALS (OPTION BY INSITE)
13	WALL INSULATION (BY OTHERS)
14	PLASTER BOARD (BY OTHERS)

**\* SOLID SHEET OPTIONS**

•	SOLID ALUMINIUM
•	ALUCOLUX®
•	PERFORATED ALUMINIUM
•	STAINLESS STEEL
•	COPPER
•	SOLID ZINC

Cladding Type :

**ENCLAD™ SOLID SHEET \***

Support System :

**ENCLAD™ EN05-FF - HOOK ON SECRET FIXED**

Detail Description :

**DOOR JAMB DETAIL(SECTION VIEW)**

Scale @ A3 : 1:2

Rev. : NOV 2022

System # :

**SS-EN05-FF-HOP-SF2**

Detail # :

**13**

**ENCLAD™ RAINSCREEN SYSTEMS**

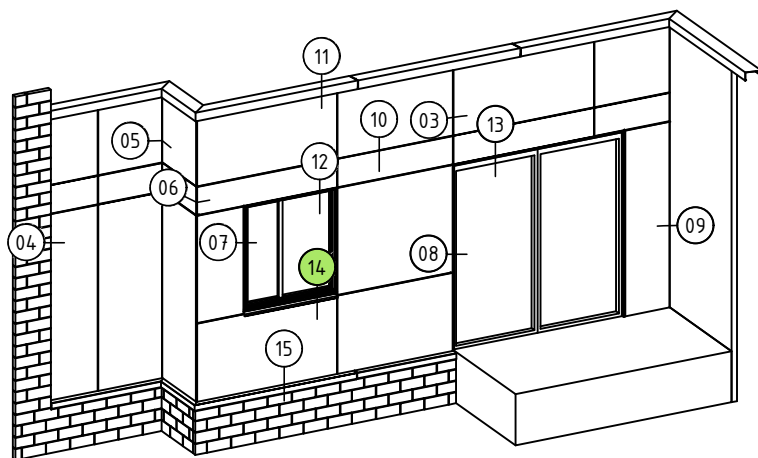
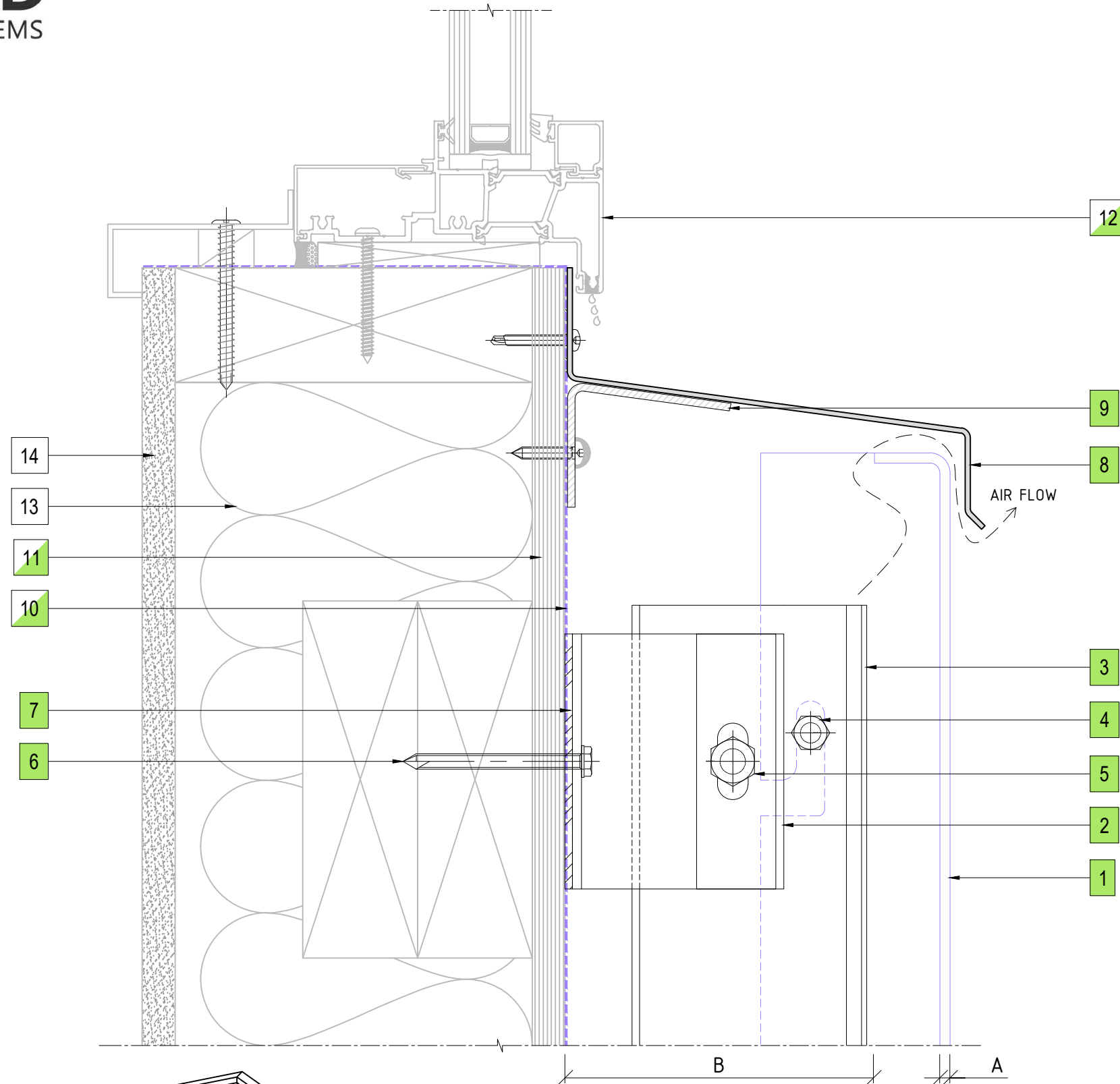

14 WINDOW SILL DETAIL  
ENCLAD™ SOLID SHEET \*

PART OF THE THERMOSASH GROUP COMPANIES :



**COPYRIGHT :** THESE DESIGNS, DETAILS AND/OR SPECIFICATIONS AND THE COPYRIGHT THEREIN, REMAIN THE PROPERTY OF INSITE FACADES LTD.

**DISCLAIMER :** THESE DETAILS ARE PROVIDED FOR INDICATIVE PURPOSES ONLY. CONSTRUCTION/SYSTEM DETAILS CAN VARY DEPENDING ON PROJECT SPECIFIC SPECIFICATION AND ENGINEERING REQUIREMENTS. THE DESIGNER IS RESPONSIBLE FOR ENSURING DETAILS SATISFY ALL NEW ZEALAND BUILDING CODE CLAUSES. THE DESIGNER IS RESPONSIBLE FOR ENSURING BUILDING WRAPS, FIRESTOPS AND INSULATION/SPECIFICATION COMPLY WITH MANUFACTURERS RECOMMENDATIONS AND NZBC REGULATIONS. REFER TO INSITE WEBSITE FOR FULL TERMS AND CONDITIONS.

**LEGEND**

A	ENCLAD™ SOLID SHEET *
B	* SYSTEM CAVITY (121mm MIN. - 146mm MAX.)
*	OTHER OPTIONS AVAILABLE (PROJECT SPECIFIC)

**PARTS LIST**

1	ENCLAD™ SOLID SHEET *
2	ENCLAD EN01 ALUMINIUM STRONG BACK PROFILE
3	ENCLAD EN01 ALUMINIUM CHANNEL PROFILE
4	ENCLAD FIXING FOR HOOK (STAINLESS STEEL)
5	ENCLAD FIXING FOR CHANNEL PROFILE (STAINLESS STEEL)
6	ENCLAD HOST STRUCTURAL FIXING (STAINLESS STEEL)
7	ENCLAD THERMAL ISOLATION PAD
8	ENCLAD ALUMINIUM FLASHING
9	ENCLAD ALUMINIUM CLOSURE
10	BUILDING WRAP / MEMBRANE (OPTION BY INSITE)
11	RIGID AIR BARRIER / SHEATHING BOARD (OPTION BY INSITE)
12	ALUMINIUM DOORS, WINDOWS & REVEALS (OPTION BY INSITE)
13	WALL INSULATION (BY OTHERS)
14	PLASTER BOARD (BY OTHERS)

**\* SOLID SHEET OPTIONS**

- SOLID ALUMINIUM
- ALUCOLUX®
- PERFORATED ALUMINIUM
- STAINLESS STEEL
- COPPER
- SOLID ZINC

Cladding Type :

**ENCLAD™ SOLID SHEET \***

Support System :

**ENCLAD™ EN05-FF - HOOK ON SECRET FIXED**

Detail Description :

WINDOW SILL DETAIL(SECTION VIEW)

Scale @ A3 : 1:2

Rev. : NOV 2022

System # :

SS-EN05-FF-HOP-SF2

Detail # :

14

**ENCLAD™ RAINSCREEN SYSTEMS**



101 STATION ROAD, PENROSE,  
AUCKLAND 1061  
NEW ZEALAND

P: +64 9 307 1529  
www.insitefacades.co.nz

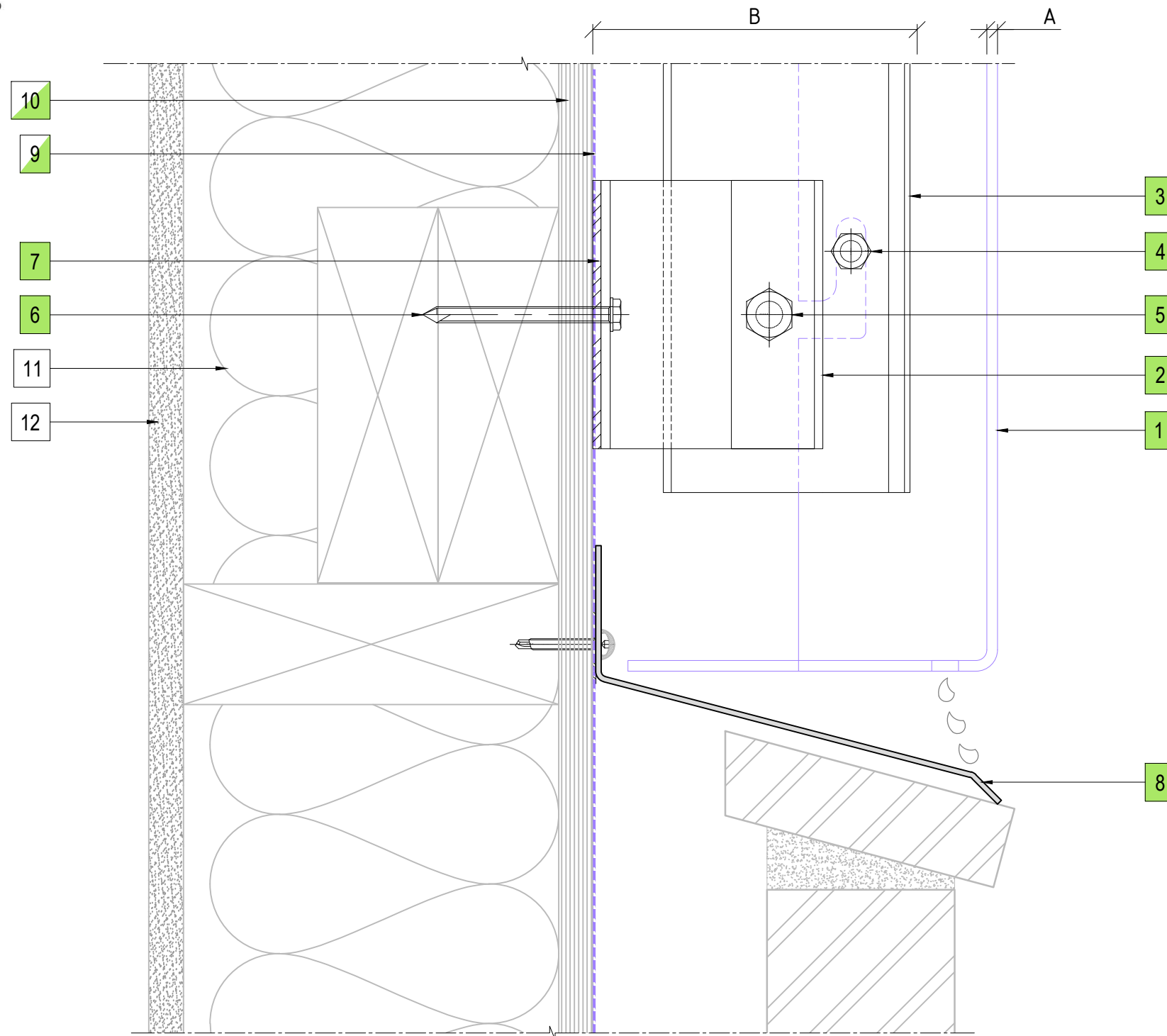

**LEGEND**

A	ENCLAD™ SOLID SHEET *
B	* SYSTEM CAVITY (121mm MIN. - 146mm MAX.)
*	OTHER OPTIONS AVAILABLE (PROJECT SPECIFIC)

**PARTS LIST**

1	ENCLAD™ SOLID SHEET *
2	ENCLAD EN01 ALUMINIUM STRONG BACK PROFILE
3	ENCLAD EN01 ALUMINIUM CHANNEL PROFILE
4	ENCLAD FIXING FOR HOOK (STAINLESS STEEL)
5	ENCLAD FIXING FOR CHANNEL PROFILE (STAINLESS STEEL)
6	ENCLAD HOST STRUCTURAL FIXING (STAINLESS STEEL)
7	ENCLAD THERMAL ISOLATION PAD
8	ENCLAD ALUMINIUM FLASHING
9	BUILDING WRAP / MEMBRANE (OPTION BY INSITE)
10	RIGID AIR BARRIER / SHEATHING BOARD (OPTION BY INSITE)
11	WALL INSULATION (BY OTHERS)
12	PLASTER BOARD (BY OTHERS)

**\* SOLID SHEET OPTIONS**

•	SOLID ALUMINIUM
•	ALUCOLUX®
•	PERFORATED ALUMINIUM
•	STAINLESS STEEL
•	COPPER
•	SOLID ZINC

Cladding Type :

**ENCLAD™ SOLID SHEET \***

Support System :

**ENCLAD™ EN05-FF - HOOK ON SECRET FIXED**

Detail Description :

**BRICKWALL AT BASE DRIP DETAIL(SECTION VIEW)**

Scale @ A3 : 1:2

Rev. : NOV 2022

System # :

**SS-EN05-FF-HOP-SF2**

Detail # :

**15**

**ENCLAD™ RAINSCREEN SYSTEMS**

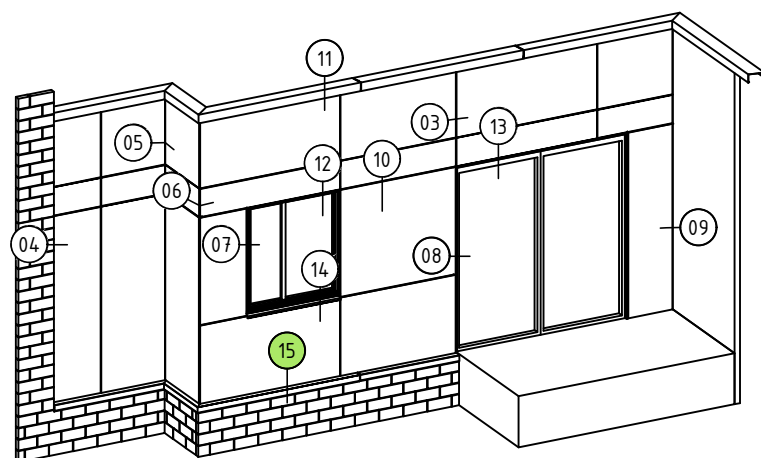

**15** BRICKWALL AT BASE DRIP DETAIL  
ENCLAD™ SOLID SHEET \*



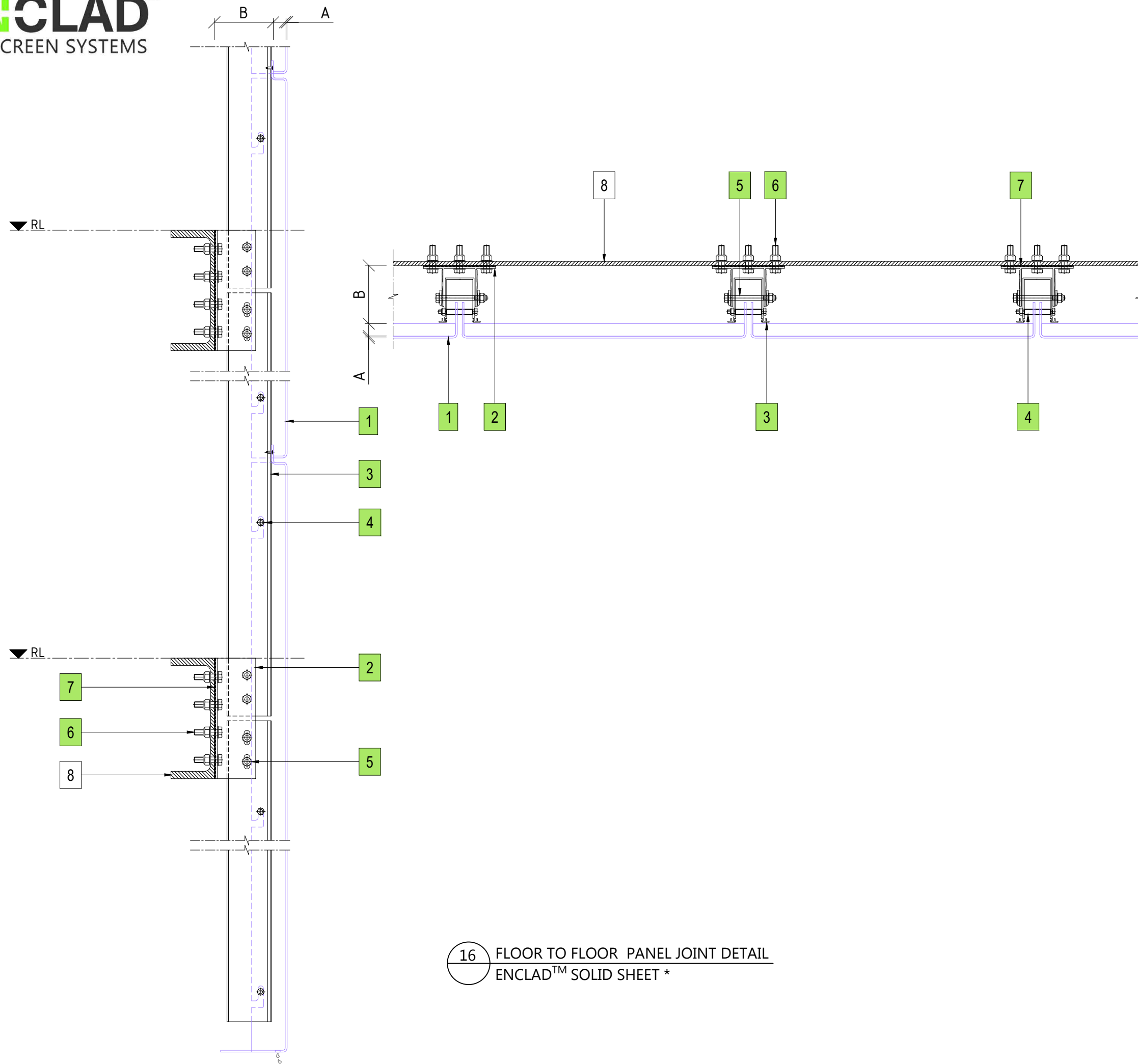

16 FLOOR TO FLOOR PANEL JOINT DETAIL  
ENCLAD™ SOLID SHEET \*

LEGEND	
A	ENCLAD™ SOLID SHEET *
B	* SYSTEM CAVITY (121mm MIN. - 146mm MAX.)
*	OTHER OPTIONS AVAILABLE (PROJECT SPECIFIC)

PARTS LIST	
1	ENCLAD™ SOLID SHEET *
2	ENCLAD EN01 ALUMINIUM STRONG BACK PROFILE
3	ENCLAD EN01 ALUMINIUM CHANNEL PROFILE
4	ENCLAD FIXING FOR HOOK (STAINLESS STEEL)
5	ENCLAD FIXING FOR CHANNEL PROFILE (STAINLESS STEEL)
6	ENCLAD HOST STRUCTURAL FIXING (STAINLESS STEEL)
7	ENCLAD THERMAL ISOLATION PAD
8	PFC (BY OTHERS)

* SOLID SHEET OPTIONS	
•	SOLID ALUMINIUM
•	ALUCOLUX®
•	PERFORATED ALUMINIUM
•	STAINLESS STEEL
•	COPPER
•	SOLID ZINC

Cladding Type :	
<b>ENCLAD™ SOLID SHEET *</b>	
Support System :	
<b>ENCLAD™ EN05-FF - HOOK ON SECRET FIXED</b>	
Detail Description :	
FLOOR TO FLOOR PANEL JOINT DETAIL (PLAN AND SECTION VIEW)	
Scale @ A3 : 1:2	Rev. : NOV 2022
System # :	Detail # :
SS-EN05-FF-HOP-SF2	16

Cladding Type :  
**ENCLAD™ SOLID SHEET \***

Support System :  
**ENCLAD™ EN05-FF - HOOK ON SECRET FIXED**

Detail Description :  
FLOOR TO FLOOR PANEL JOINT DETAIL  
(PLAN AND SECTION VIEW)

Scale @ A3 : 1:2	Rev. : NOV 2022
System # :	Detail # :
SS-EN05-FF-HOP-SF2	16